

1. **Input B**, DIN 45326 8-pole connector
2. **Input A**, DIN 45326 8-pole connector
3. Battery symbol: indicates the battery charge level
4. First display line (line X)
5. Third display line (line Z)
6. Key <**F2**>: activates the central command on the controls bar
7. Key <**F1**>: activates the left-hand command on the controls bar
8. Key <**MENU**>: displays the instrument's functions menu
9. Key <**ESC/CLR**>: allows you to move about in the menu, passing to the higher level; cancels the current operation without modifying the instrument parameters. It clears the peak value related to pressure measurements.
10. Key <**7/HOLD**>: in the menu it writes the number 7; in normal operation it freezes the measurement.
11. Key <**5/DATA CALL**>: in the menu it writes the number 5; in normal operation it recalls the minimum (key <F1>), maximum (key <F2>) and mean (key <F3>) value of the three inputs
12. Key <**4/SERIALOUT**>: in the menu it writes the number 4; in normal operation it activates the menu for the "Serial output" function
13. Key <**1/MATH**>: in the menu it writes the number 1; in normal operation it activates the function that manages mathematical operations
14. Key <. > (decimal point): in the menu it writes the decimal point. When pressed after the <MENU> key, it switches over the instrument's Auto Power Off function.
15. Key <**0**>: in the menu it writes the number zero. In measurement mode, it adjusts the offset of probes provided with this function.
16. Key <**LEFT/UP**>: in the menu it shifts the cursor up or to the left, in measurement it increases the display contrast
17. **RS232C** 9-pole connector
18. External auxiliary power supply connector
19. Key <**RIGHT/DOWN**>: in the menu it shifts the cursor down or to the right; in measurement it decreases the display contrast
20. Key <**ENTER**>: in the menu it accepts the active function. In measurement mode, it provides or cuts off power supply to the hot-wire probe.
21. Key <+/->: in the menu it inserts the "-" sign in front of a number. Using the SICRAM module PP471 for pressure probes TP704 and TP705, it activates and deactivates the relative function.
22. Key <**3/TIME**>: in the menu it writes the number 3; in normal operation it activates the menu for the Time function
23. Key <**2/LOG**>: in the menu it writes the number 2; in normal operation it activates the menu for the Logging function
24. Key <**6/RCD**>: in the menu it writes the number 6; in normal operation it activates the menu for the Record function
25. Key <**9/UNIT**>: in the menu it writes the number 9; in normal operation activates the menu for selecting the unit of measurement for the three inputs
26. Key <**8/REL**>: displays the difference between the current value and the one stored the moment the key was pressed
27. Key <**ON/OFF**>: switches the instrument on and off
28. Key <**F3**>: activates the right-hand command on the controls bar
29. Controls bar (the indications vary according to the active function)
30. Second display line (line Y)
31. Indications of the active functions
32. Internal temperature indication
33. **Input C**, DIN 45326 8-pole connector

## INTRODUCTION

- Portable multifunction instrument
- Datalogger with immediate or delayed start of logging (programming of autostart and autostop)
- Large graphic display (56x38mm) with adjustable contrast
- Intelligent probes with automatic recognition: they store the factory and user calibration data
- Possibility of using factory or user calibration
- Functions: Record, Logging, difference between two channels, relative measurement, hold, ...
- Reserved functions with user password
- Standard RS232C serial port
- Immediate printing of the measured values or of their differences with indications of the max, min and mean (avg) values of each channel
- Automatic shut-off which may be excluded
- Selectable units of measurement
- Updating of firmware may be carried out through the via RS232C serial port

**This manual relates to DO9847, version 3.0. Prior versions of DO9847 are not provided with some of the functions described in this manual.**

## KEYBOARD DESCRIPTION

**ON/OFF**

**ON/OFF Key**

To switch the instrument on and off, hold down the ON/OFF key **for at least one second**. When switching on the instrument checks what probes are connected to its inputs: if any variations have occurred with respect to the previous measuring session, the opening screen appears with the software version and, after a few moments, the instrument goes into standard measuring condition displaying the channels set just as the switching off.

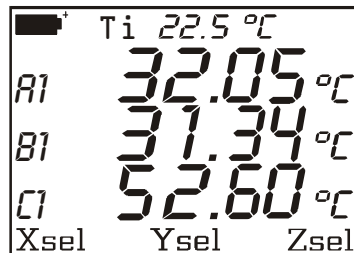

If there has been a variation because, for example, a probe has been disconnected, the following message appears: *“WARNING! CHANGE OF PROBES DETECTED – Press NOW any key to choose settings or wait self-config”*. When any key is pressed **within 3 seconds** the menu is opened in which the instrument configuration parameters may be modified. If you do not think it is necessary to alter them, just wait 3 seconds, afterwards the instrument return automatically to standard measuring conditions with the indications of the first free channels available among A1, B1, C1, A2, B2, C2, A3, B3, C3 and Ti.

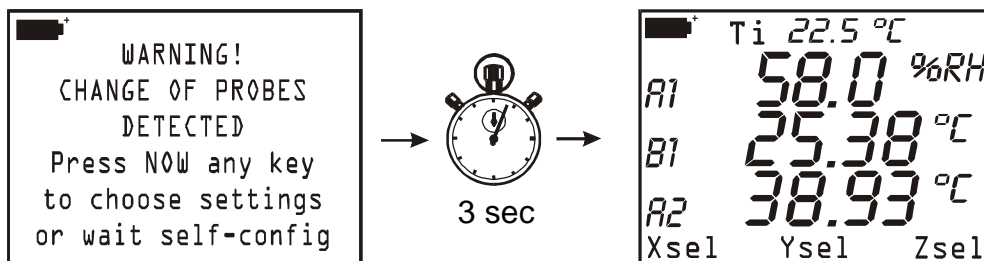

If, for example, a module for measuring the combined humidity and temperature is connected to the input A and a module Pt100 to the input B, the automatic configuration arranges the display in this way: first line %R.H. (A1), second line temperature of the Pt100 probe (B1), third line temperature of the combined probe (A2). If no module is connected to any input, Ti internal temperature will be viewed.

The instrument has an automatic shut-off function (*AutoPowerOff*) which automatically switches off the instrument after 8 minutes with the batteries fully charged or after 1 minute with the batteries partly charged, if no key has been pressed in this interval. The *AutoPowerOff* function may be disabled by pressing the keys <MENU> and then <DECIMAL POINT>: in this case a letter **B** (Battery) flashes to remind the user that the instrument will not switch off automatically but only when the <ON/OFF> key is pressed. The automatic shut-off function is disabled when using an external source of power. When batteries are flat, this function cannot be disabled.

---

**MENU****MENU Key**

When the <MENU> key is pressed, a warning appears to remind the user that this function blocks the measurement and logging operations.

```
■■■■+
  !!WARNING!!
MEASURE and LOGGING
will be STOPPED
in MENU mode
<ENTER> confirm
<.> toggle auto-off
<ESC> cancel
```

Press:

<ENTER>

to access the menu or

<ESC/CLR>

to return to measuring mode without terminating the current operations or

<.> (decimal point)

to toggle the *automatic shut-off* function (*AutoPowerOff*) of the instrument. The function is not active, so the instrument **does not** switch off automatically if the flashing letter **B** is present at the top of the display.

From the MENU screen, pressing the number to the left of each item, it is possible to access the following sub-functions (*for details see page 15 and following*):

```
■■■■+
-- MAIN MENU --
0)Info    1)Config
2)Logging 3)Time/date
4)Serial  5)Calibrate
6)Reset   7)Utility
8)Options 9)More
<ESC> exit/cancel
```

0) *Info* collects information about the firmware version, the serial number and the last calibration date of the instrument and of the connected probes.

1) *Config* for managing the reserved functions with password.

2) *Logging* for setting the logging parameters.

3) *Time/date* for setting or modifying the current date and time.

4) *Serial* for setting the baud rate of the RS232C serial port and the printing interval (in seconds).

5) *Calibrate* for calibrating the instrument and the probes. The calibration of the combined “probe + instrument” may be protected with a user password.

6) *Reset* to return the instrument parameters to default conditions (date, time, configurable options protected by password, baud rate, printing interval, logging functions).

7) *Utility* makes a list of calculating instruments and functions related to some specific modules.

8) *Options* sets reference calculating parameters related to some modules.

9) *More* jumps to the next page of the menu.

---

**ESC/CLR**

**ESC/CLR Key**

In the menu, it cancels or annuls the active function. In measurement, it cancels the active function that appears on the controls bar (bottom line of the display) and returns the instrument display to the basic screen with the functions Xsel, Ysel and Zsel on the controls bar.

---

**0**

**Key 0**

In the menu it writes the number zero. In measurement mode, it sets to zero the difference between the inputs of differential pressure probes and adjusts the zero point in hot wire and Pitot tube probes.

---

**1**

**Key 1 / MATH**

**MATH**

In the menu it writes the number 1; in measurement, it manages mathematical operations and data handling.

---

**2**

**Key 2 / LOG**

**LOG**

In the menu it writes the number 2; in measurement, it starts the Logging function using the parameters set in the menu under the heading "Logging".

Starting from the measuring screen, when the key <2/LOG> is pressed, the two logging functions appears on the controls bar: when the <F1>SCREEN key is pressed, data logging will start just as the data appear on the display at that moment; when the ALL<F3> key is pressed, all the variable of the three input channels are logged (A1, A2, A3, B1,...,C2, C3 and the internal temperature Ti).

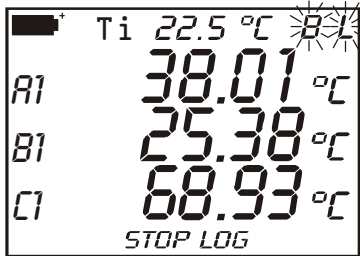
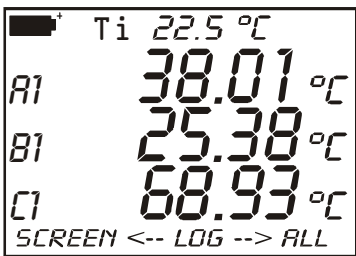

As long as the logging function is active, the indications **B** and **L** flash on the display or only **L** if the instrument is using an external power supply.

To conclude the logging operation, it is sufficient to press the StopLog <F2> key.

If after having pressed the key <2/LOG>, you do not want to proceed with the logging operation it is sufficient to press the <ESC/CLR> key to return to normal measurement.

The same logging function may be started and stopped at a fixed time and date (*see the Logging function on page 88 and the respective settings on page 17*).

**3**

**Key 3 / TIME**

**TIME**

In the menu it writes the number 3; in measurement it displays the current time and date in the year/month/day format. The indication disappears about 5 seconds after pressing the key <3/Time>. The date and time may be modified in point 3) of the menu: Time/date (*see page 22*).

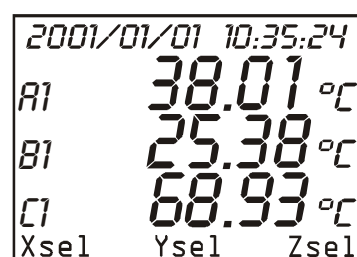

**4**

**Key 4 / SERIAL OUT**

**SERIAL  
OUT**

In the menu it writes the number 4; in measurement it enables the submenu for managing the operations connected with the RS232C serial output; the data are printed in table form. The functions that can be activated with the three function keys F1, F2 and F3 are:

*Screen* – key < F1 > – unlimited continuous printing of the data just as they are shown on the display at the time of starting the function,

*RCD+* – key <F2> – same as *Screen* function, plus the indication of the maximum, minimum and mean values up to a maximum of 100,000 samples,

*ALL* – key < F3 > – prints the 9 quantities A1, A2, ..., C2, C3 and the internal temperature.

If an external power source is connected, letters **P** and **B**, or letter **P** only, flash as soon as the *Screen* function or the *ALL* function is started; when the *RCD+* function is started, letters **B**, **P** and **R** flash and, while, in case an external power supplier is connected, letters **P** and **R** will flash. if an external power source is connected.

To conclude the operation in progress, press the stop key F1 (*see p. 86 and following*).

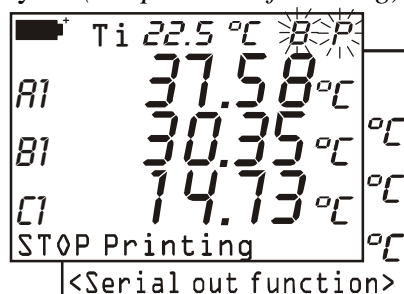
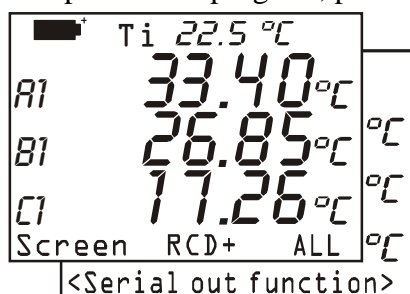



---

**5****Key 5 / DATA CALL****DATA  
CALL**

In the menu it writes the number 5; in measurement it allows you to call up the maximum (*max*), minimum (*min*) and mean (*avg*) values of the data acquired by the three channels and stored with the *RCD* function (key <6/RCD>). The function is active only if some data have been logged previously or if the *Record* function is active at that time. In this case, the display appears as in the figure alongside, otherwise there is the message:

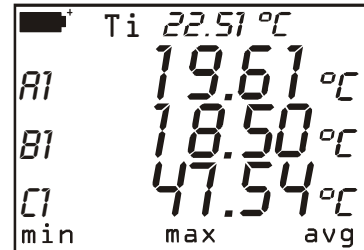

*no records available*

To return to normal measurement, press the function key next to the indication *norm*.

---

**6****Key 6 / RCD****RCD**

In the menu it writes the number 6; in measurement it enables the submenu for the *Record* function which stores the maximum, mean and minimum values of the three channels. The function <F1> (*rcdGO*) starts logging at a rate of one sample per second (the symbols **B** and **R** – or only **R** if an external power source is connected – flash on the display). The function <F2> *M*(n=00) stores a sample each time the F2 key is pressed (the symbols **B** and **M** – or only **M** if an external power source is connected – flash on

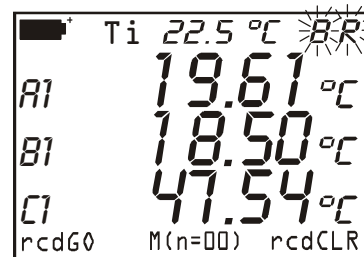

the display). The function <F3> (*rcdCLR*) cancels the previously recorded data and the function <F2> (*rcdSTOP*) stops recording started with *rcdGO*. The stored data may be called up using the *DataCall* function, key <5/DATA CALL> (*see p.86*).

---

**7****Key 7 / HOLD****HOLD**

In the menu it writes the number 7; in measurement it freezes the measurement in progress the moment the key is pressed. The message **HOLD** appears at the top of the display. Press the key again to return to normal measurement.

---

**8****Key 8 / REL****REL**

In the menu it writes the number 8; in measurement it displays, for the three channels, the difference between the current value and the one measured at the time the key was pressed. The message **REL** appears at the top of the display; press the key again to return to normal measurement.

---

**9****Key 9 / UNIT****UNIT**

In the menu it writes the number 9. In measurement it displays the submenu from which it is possible to choose the unit of measurement of the quantities at input. *F1 (unitX)* refers to the measurement which appears on the first line of the display, *F2 (unitY)* to the measurement which appears on the second line and *F3 (unitZ)* to the third. When the function key is pressed repeatedly, the possible units are presented: for example, if the measurement taken by a temperature probe connected to the instrument appears on the first

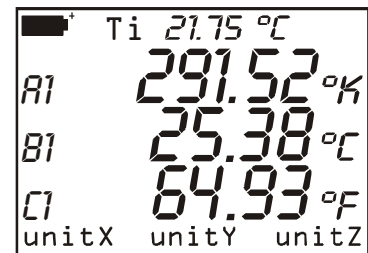

line of the display, when the function key *F1* is pressed the measurement will be displayed in °C, in °F and in °K. When the key *F1* is pressed again the measurement will return to in °C. If only one unit of measurement is contemplated, pressing the respective key will produce no consequence. The setting influences all that is shown on the display and the immediate printing of data (key <4/SERIALOUT>). **The data stored with the LOG (logging) function keep the units of measurement chosen at the time of recording.**

---

**.****“.” / Decimal point Key**

In the menu it writes the decimal point. When pressed after the <MENU> key, it toggles the instrument's automatic shut-off function *AutoPowerOff*.

---

**+/-****“+ /-” Key**

In the menu it allows you to insert the “-” sign in front of a number or in a mathematical function. Activates and deactivates the relative function with SICRAM module PP471 for TP704 and TP705 pressure probes.



**Up / Left Key**

Key for shifting the cursor during data input in the menu and for regulating the display contrast: if the key is pressed, when outside the menu, it increases the display contrast.



**ENTER Key**

**ENTER**

Key for confirming the active function. To increase battery life, it applies and turns off power supply to the hot wire probes, when connected.



**Down / Right Key**

Key for shifting the cursor during data input in the menu and for regulating the display contrast: if the key is pressed, when outside the menu, it decreases the display contrast.

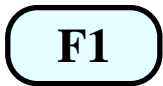

**Function key F1**

Function key *F1*. The function performed by this key varies according to the active operation. (For the *Xsel* function see the paragraph “**Xsel, Ysel and Zsel commands**” )

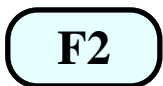

**Function key F2**

Function key *F2*. The function performed by this key varies according to the active operation. (For the *Ysel* function see the paragraph “**Xsel, Ysel and Zsel commands**” )



**Function key F3**

Function key *F3*. The function performed by this key varies according to the active operation. (For the *Zsel* function see the paragraph “**Xsel, Ysel and Zsel commands**” )

---

## Use of the <Hold> key

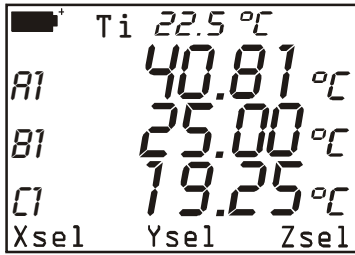

Ti 22.5 °C  
A1 40.81 °C  
B1 25.00 °C  
C1 19.25 °C  
Xsel Ysel Zsel

CURRENT MEASUREMENT

→ press

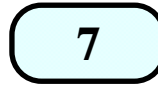

**HOLD**

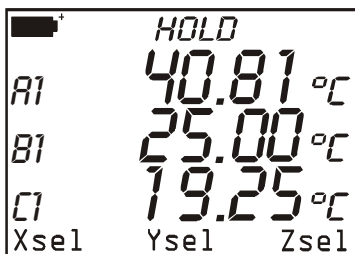

HOLD  
A1 40.81 °C  
B1 25.00 °C  
C1 19.25 °C  
Xsel Ysel Zsel

MEASUREMENT "FROZEN"

the message "HOLD" appears  
the values on the display are not updated

→ press

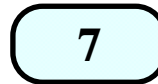

**HOLD**

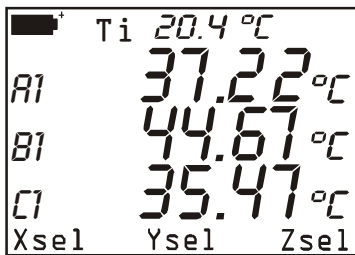

Ti 20.4 °C  
A1 37.22 °C  
B1 44.67 °C  
C1 35.47 °C  
Xsel Ysel Zsel

CURRENT MEASUREMENT

Use of the <REL> key

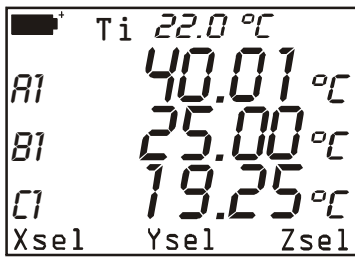

CURRENT MEASUREMENT

→ press

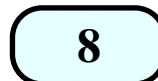

REL

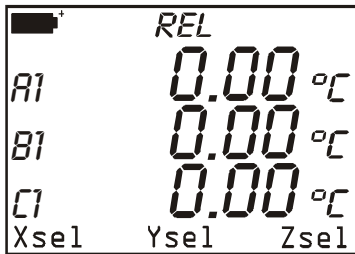

The display shows the relative measurement, equal to zero if the input signal has not varied in the meantime.

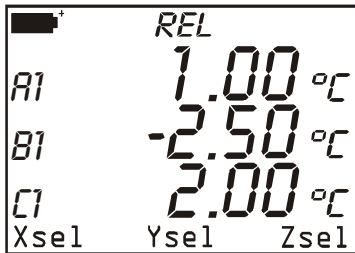

The display shows the relative measurement. Channels A and C have increased, channel B has decreased.

→ press

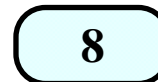

REL

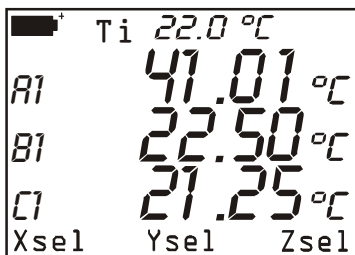

CURRENT MEASUREMENT

## XSEL, YSEL AND ZSEL COMMANDS

In the basic display, the function F1 is associated with the *Xsel* command. With this command it is possible to set the variable that is to appear on the first line of the display: this variable refers to all three inputs of the instrument. Each probe has a maximum of three variables: for example, in the SICRAM module TP471D1 with two thermocouple inputs connected to connector A of the instrument, A1 represents the first thermocouple, A2 the second and A3 the sensor which measures the temperature of the cold junction. If you press F1 (*Xsel*) repeatedly, the first line of the display will show either all available variables, according to the modules connected to the instrument inputs, or the instrument internal temperature (Ti), or no measurement. In this case, the “>>” symbol will appear on the left side of the instrument. In addition to the variables associated with each probe (A1, A2, A3, B1, ... , C3), you can also select the difference between two of the three inputs identified with the number 1 (A1-B1, A1-C1 and B1-C1). The difference between two inputs is available only if probes of the same type are connected to these inputs, for example two thermocouples, two relative humidity probes, two Pt100. The difference between different types of probes is not available, even if they refer to the same physical quantity: for example the difference between a Pt100 and a thermocouple, even they both measure temperature, as well as the difference between two pressure probes having a different full scale.

Associated with the functions F2 and F3 are the *Ysel* and *Zsel* commands are used to set respectively the variables on the second and the third line of the display.

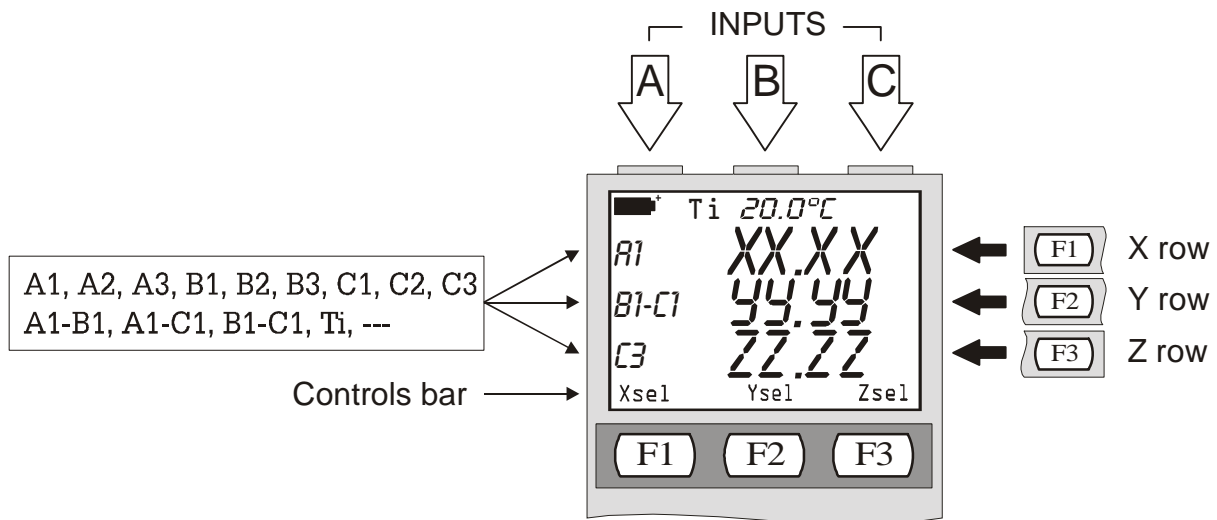

## DESCRIPTION OF THE MENU FUNCTIONS

The menu contains all the functions by means of which the parameters for instrument operation are set.

When the <MENU> key is pressed, the instrument informs the user that, on entering the menu, any Measuring and Logging functions in progress will be terminated. To return to the menu without losing data, press <ESC>.

The < DECIMAL POINT > key, pressed after the <MENU> key, toggles the automatic shut-off function (*AutoPowerOff*). When the function is not active and an external source of power is not connected, a letter **B** flashes at the top of the display: in this case the instrument does not switch off automatically after 8 minutes of inactivity.

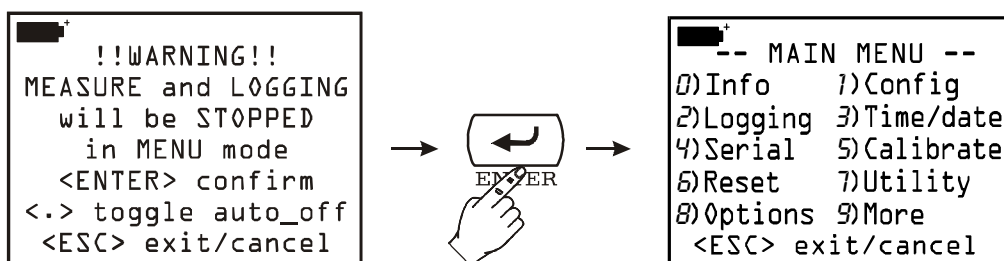

The basic menu screen (shown in the square on the right of the figure) supplies the list of the various functions.

**To access each item in the menu, press the key corresponding to the number shown in front of each function.**

### 0) INFO (Information)

The *Info* function provides information about firmware, serial number and date of calibration of both the instrument and the connected probes. Press Enter to jump from the first to the second visual display.

Press the <ESC/CLR> key to quit and return to the basic menu screen.

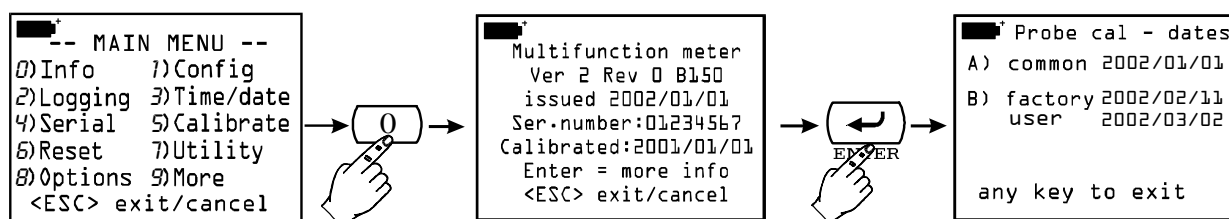

### 1) CONFIG (Configurations)

Manages the reserved functions with password.

Some instrument functions may be protected with a password: for example access to calibration of the probes and/or the instrument, modifying the date and/or the time, ...

#### 1-1) Reserved Function Lock

There are two levels of password protection: factory level and user level. Each is protected with the respective password: the *factory level* is used to protect certain basic functions of the instrument and for this reason it is not accessible to the user. When the instrument leaves the production line or after calibration in the factory, it is protected by a factory password; on the other hand, access to the functions reserved for the user is enabled. To change the enabled or

disabled status of the reserved functions, type in the user password and then confirm it with the <ENTER> key. To quit the function without making any changes, press the clear key <ESC/CLR>.

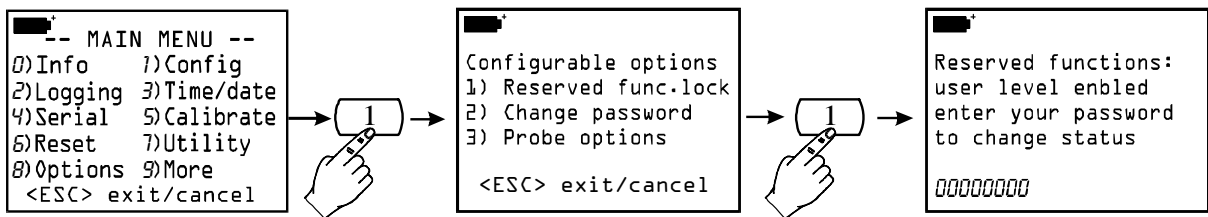

### 1-2) Change password

To change the user password:

A) enable the reserved functions, if this has not been done, by typing in the present password in point 1) of the Config submenu (see the previous point: *Reserved function lock*)

B) use the function of the *Change password* menu to type in the new password: type the 8 figures and then confirm with the <ENTER> key. To quit the function without making any changes, press the clear key <ESC/CLR>.

Note: when the instrument is switched on for the first time, after changing the batteries or after reset, the user password is automatically set at **12345678**.

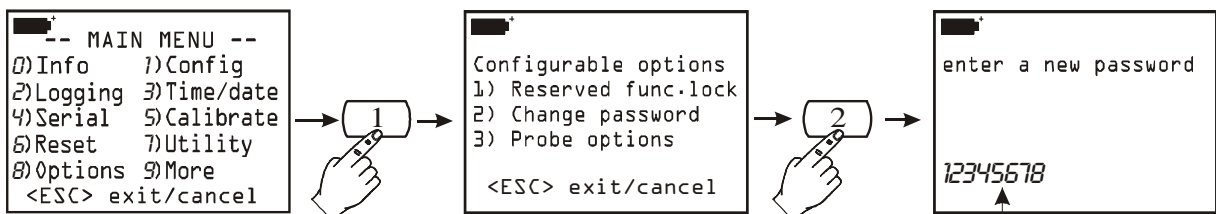

If user level is enabled, current password is proposed

### 1-3) Probe options

If enabled by a password, this function allows you to configure the type of calibration of each probe present at the instrument inputs. The standard procedure is as follows: the instrument detects the presence of a probe at one of its inputs and reads its calibration data.

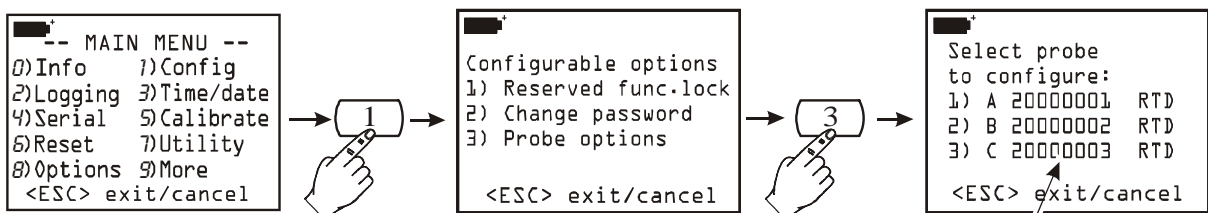

Serial numbers of the probes connected to the instruments

If the probe contains only factory calibration data (indicated with the code “0 factory”), the instrument will use these parameters.

If user calibration data are also present in the probe (indicated with the code “1 user”), the user calibration will be used only if it has been carried out with the same instrument and not with another one.



This standard rule may be modified by configuring the instrument so as to use one type of calibration rather than another.

0) **factory**: the probe, connected to the instrument input, will use the factory calibration values inserted in the probe memory before sale or after recalibration in the factory, even if a user calibration carried out with the same instrument is present. this choice is useful, for example, if there are doubts as to the correctness of the user calibration.

1) **user**: the calibration values used are those referring to a user calibration even if they were obtained with a different instrument. If these are not present, for example because the probe is new, the instrument will use the factory values.

To modify the type of calibration of a probe, select it, choose the new type of calibration and then confirm with the <ENTER> key.

In the example below, the probe connected to input A uses the factory calibration and is configured so as use the user calibration.

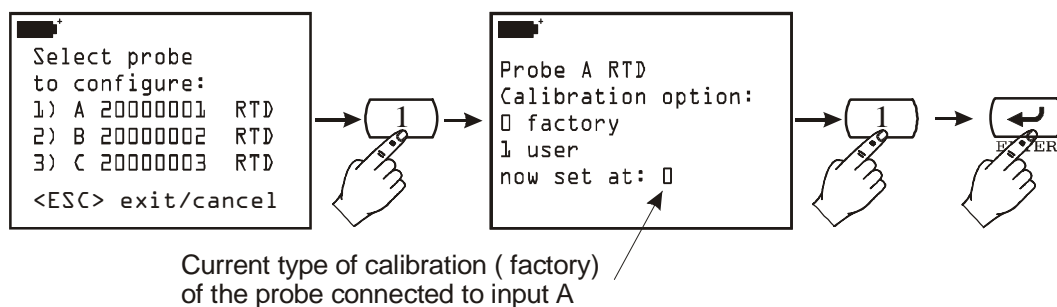

To quit the function without making any changes, press the clear key <ESC/CLR> instead of the <ENTER> key.

## 2) LOGGING

The Logging heading comprises the settings of the function for storing the data at instrument input, which may be activated by means of the LOG function (key <2/LOG>).

To access each item in the menu, press the key corresponding to the number shown in front of each function.

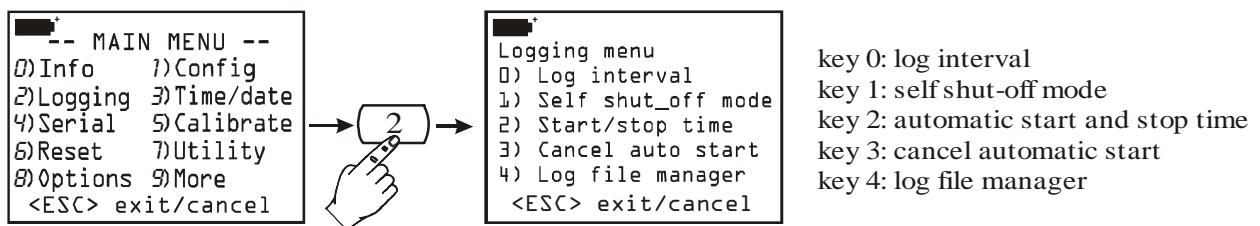

### 2-0) Log Interval

This is the time interval between two consecutive logging sessions. To set a new interval, on the menu select the item *Logging* with the key <2/LOG> and then the function *Log interval* with the key <0>; type in the new interval – from 0001 to 3600 – and then confirm with the <ENTER> key.

To quit the function without making any changes, press the clear key <ESC/CLR>

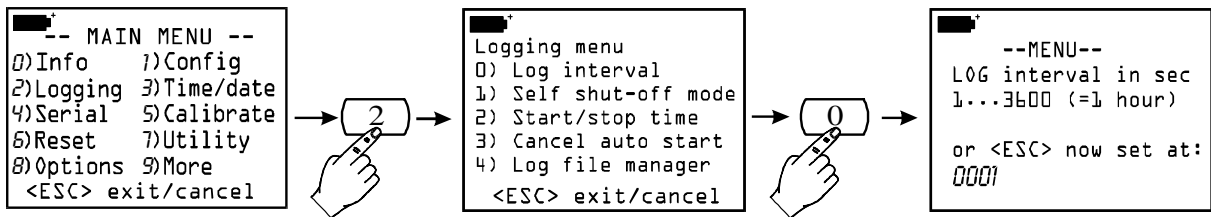

## 2-1) Self shut-off mode

The instrument switches itself off automatically during logging between one sample acquisition and the next.

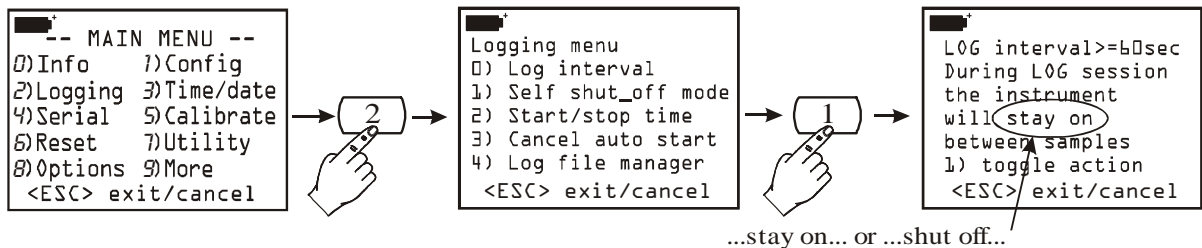

If the logging interval is less than 60 seconds, the instrument will always stay on. For intervals of 60 seconds or more, it is possible to choose to switch off the instrument between two consecutive logging sessions: the instrument will switch during sampling and then switch off immediately afterwards, thus prolonging the life of the batteries. The  $\langle 1/\text{MATH} \rangle$  key toggles the function: always on (...stay on...) or on/off (...shut off...). To set the desired type of operation, from the menu press the key  $\langle 2/\text{LOG} \rangle$  to Enter the *Logging* sub-menu, then press the key  $\langle 1/\text{MATH} \rangle$  to activate the window for the *Self shut\_off mode* sub-function. With the key  $\langle 1/\text{MATH} \rangle$ , choose the desired type of operation always on (...stay on...) or on/off (...shut off...) – and then quit pressing the  $\langle \text{ESC}/\text{CLR} \rangle$  key.

## 2-2) Start/stop time

Starting and stopping of logging may be programmed by typing in the date and the time. When it is called, the function proposes, as start time, the current time increased by 5 minutes: to confirm press  $\langle \text{ENTER} \rangle$ , otherwise set the date and time using the arrows. When asked to set the data for the end of logging: by default the instrument proposes the start time increased by 10 minutes. To confirm press  $\langle \text{ENTER} \rangle$ , otherwise set the date and time using the arrows and press  $\langle \text{ENTER} \rangle$ . At the next screen the variables to be stored have to be selected: press SCREEN to select the three variables which appear on the display, select ALL to store all the variables (A1,...C3) and the internal temperature.

The instrument proposes the setting just made: press  $\langle \text{ENTER} \rangle$  to confirm it or  $\langle \text{ESC} \rangle$  to refuse it. The letter “s” flashing on the display reminds you that the logging operation has been programmed.

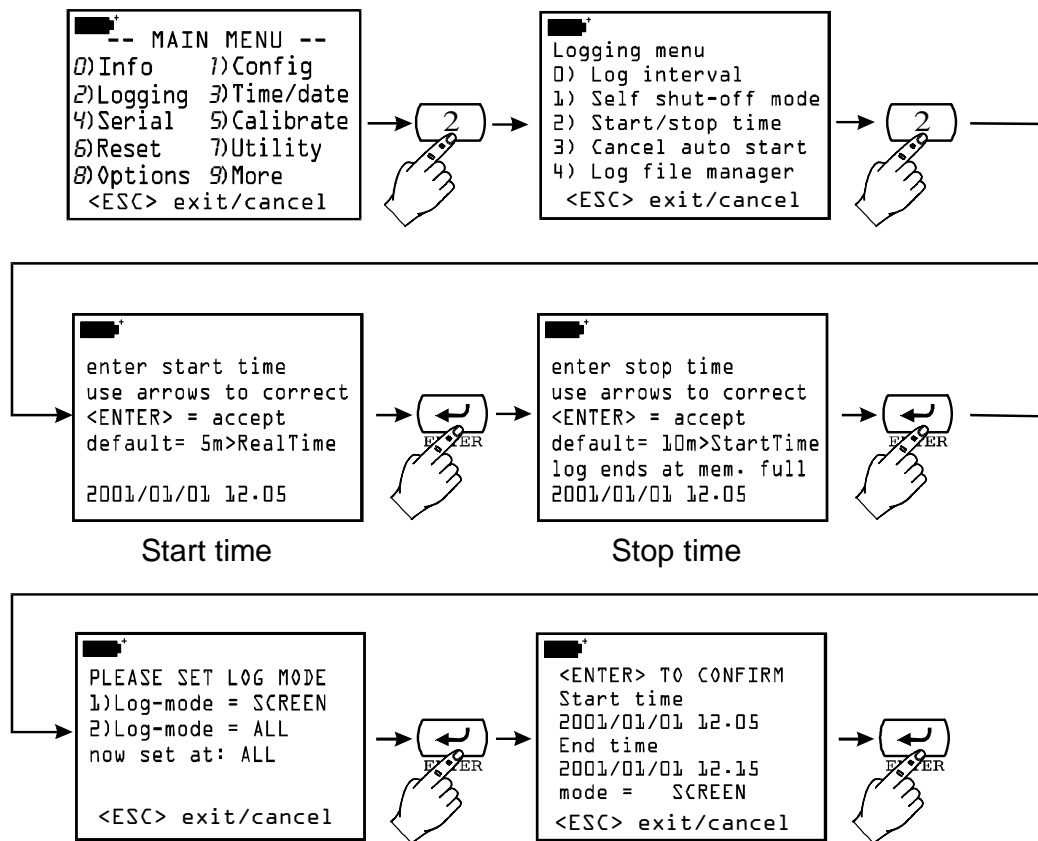

### 2-3) Cancel auto start

This function allows you to check the setting of the starting and stopping of logging and, if necessary, to cancel the operation. After having viewed the settings, to quit **leaving the autostart operation active**, press <ESC>. To cancel the operation, press the key <1/MATH>.

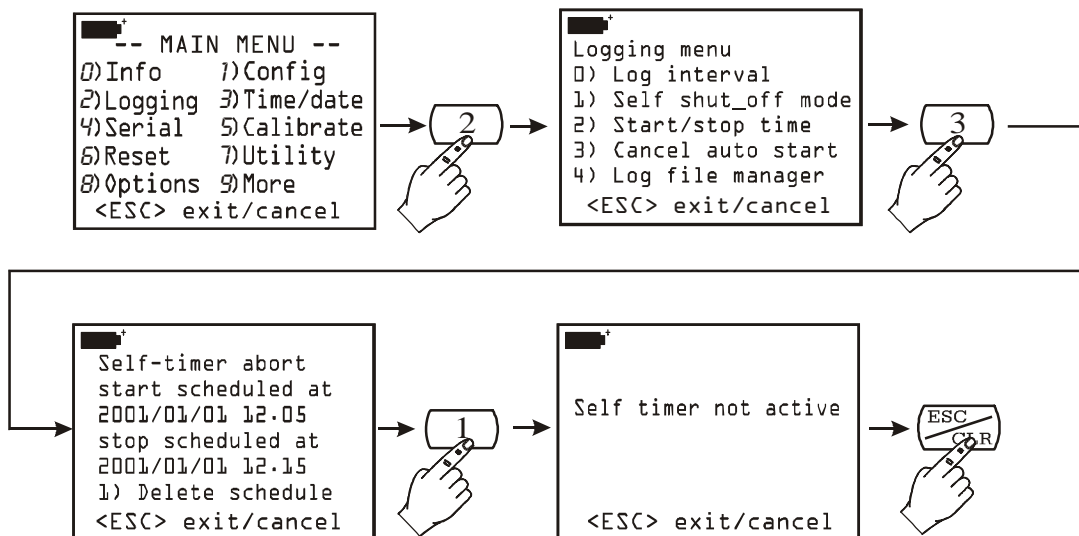

Cancelling automatic start and stop  
 Start programmed for 2001/01/01 at 12.05  
 Stop programmed for 2001/01/01 at 12.15  
 Press the key <1/MATH> to cancel the operation  
 Press <ESC/CLR> to quit without cancelling  
 the operation.

The automatic start and stop  
 timer is not active  
 Press <ESC/CLR> to continue

## 2-4) Log File Manager

Manages the files of logged data. Whenever a logging session is started (with the key <2/LOG>), the instrument opens a new file with which it associates the date, the start time and a number from 00 to 15: in this file are saved all the measurements acquired until the end of the logging session. The file is composed of *pages*: each page can contain up to 16 data (one datum corresponds to a measurement of the three variables which appear on the display) on SCREEN logging mode while, on ALL mode each page contain up to 5 data (each data corresponds to a measurement of all variables A1,..., C3 and the internal temperature). Up to 16 different data files are contemplated corresponding to 16 different logging sessions. The size of the instrument's memory guarantees a maximum of 2000 total pages for the 16 files, without any restraint for the size of each file. When the limit of 2000 pages or of 16 logged files is reached and you start a new logging session, the instrument generates a warning: "WARNING: MEMORY FULL!!" In this case, before proceeding, you must delete at least one of the log files.

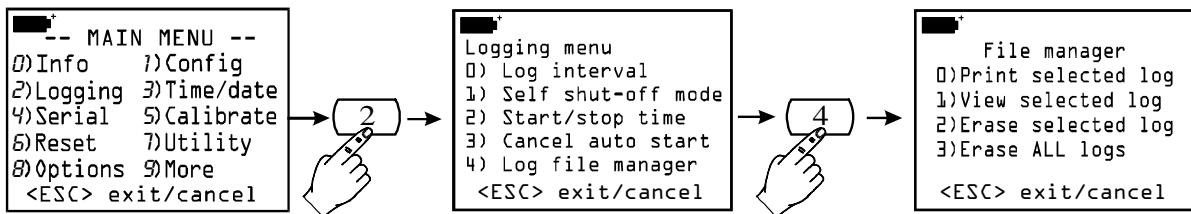

The function **2-4) Log file manager** is subdivided into 4 sub-functions with which it is possible to see, print or delete the log files.

### 2-4-0) Print Selected Log

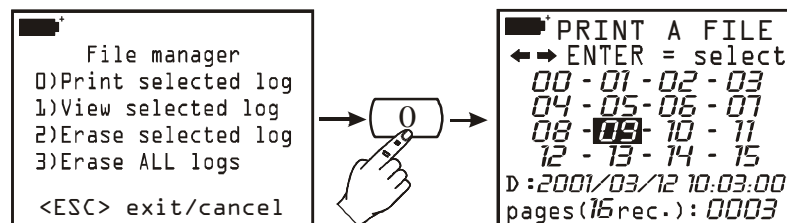

This function allows you to select and print a file of logged data. To select a file, use the arrows to shift to the numbers from 00 to 15. A file is associated with each number: when selected, the date, time and dimensions of the file appear in the two lines at the bottom of the display. Attention: there is no time relationship between the number associated with the file and the date of the file: a lower number does not mean that the file is older. Each file is identified only by its date and time. **To help the user, when entering the print and display functions the most recent file is proposed while in the delete functions the oldest file is proposed.**

In the example shown above, file 09 is selected: logging was started at 10:03 on 12 March 2001 and the file contains 3 pages of data. To print it, it is sufficient to set up the computer or the printer (*see the chapter "THE FUNCTIONS OF STORING AND TRANSFERRING DATA TO A PERSONAL COMPUTER" on p. 86*) and press the <ENTER> key. At the end of printing, press <ESC/CLR> to return to the File Manager.

### 2-4-1) View Selected Log

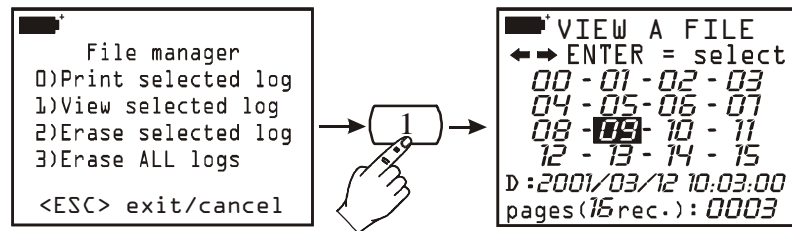

The function enables viewing of the log files directly on the display of the instrument. Select the file with the arrows and then press <ENTER>: the file date and time are presented. Press <ENTER>: the first logged datum appears; using the Up arrow (Δ) move on to the next datum and so on for all the others. On reaching the last datum, there appears the indication “END OF LOG DETECTED!”. Use the arrows to move about among the logged data, press <ESC/CLR> to quit and return to the File Manager.

Each file generated with LOG>>ALL function is composed of 10 variables: the measures A1, A2,..., C2, C3 and the internal temperature Ti. As the LCD can display not more that three variables at a time, these files aren't displayed, but they can be transferred to a PC with the function PRINT SELECTED LOG.

### 2-4-2) Erase Selected Log

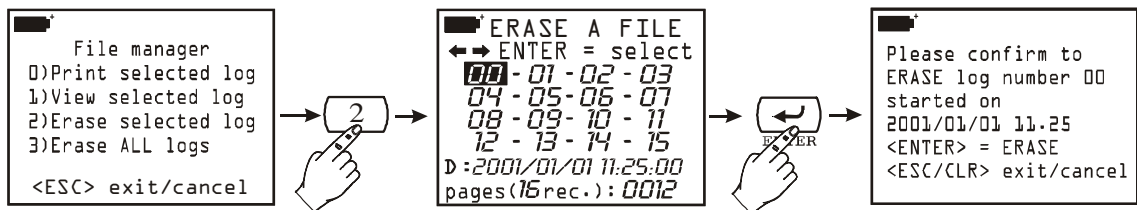

This function gives access to the menu for erasing single selected files. Select a data file using the arrows, then to erase it press <ENTER>. A confirmation screen appears: press <ENTER> again to proceed with erasure, <ESC/CLR> to cancel the operation and return to the File Manager.

**Attention: the erased files cannot be recovered!**

### 2-4-3) Erase ALL logs

This function allows you to erase ALL the files in the memory: press <ENTER> to proceed: a message appears reminding you that ALL the files in the memory will be erased definitively. Press <ENTER> to proceed with erasure or <ESC/CLR> to cancel the operation.

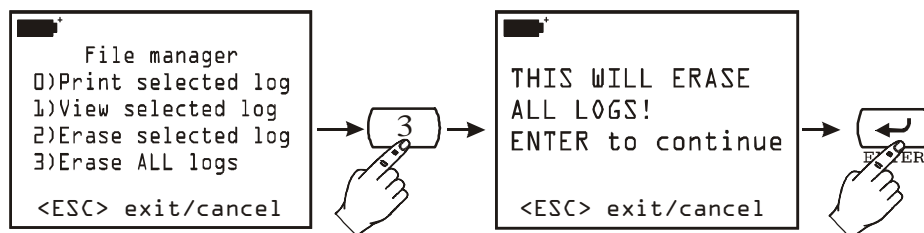

**Attention: the erased files cannot be recovered!**

### 3) TIME/DATE

Allows you to set the current time and date. The current time is proposed, increased by one minute because, when you confirm with the <ENTER> key, the seconds start from 00. This allows you to synchronise the time precisely to the second: for example, if the time is now 10.34.23 and you go into the TIME/DATE function, the instrument will propose 10.35: when you press <ENTER>, the time 10.35.00 will be set. To quit the function without making any changes, press <ESC/CLR>.

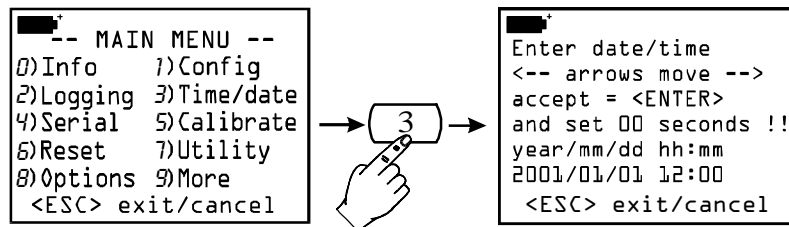

### 4) SERIAL (DIGITAL COMMUNICATION)

Menu for setting the RS232C serial connection.

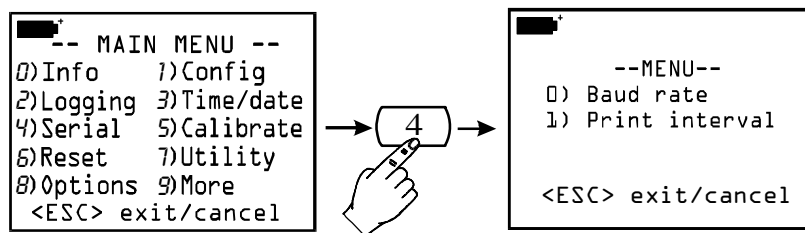

#### 4-0) Baud Rate

It is possible to set the baud rate of the serial communication from 300 to 115200 baud. The default value is 19200. On the setting screen, press the number key from 0 to 7 next to each baud rate value to select it. Confirm your choice with the <ENTER> key. Press <ESC> to quit without making any changes.

**The communication between the instrument and a computer (or a printer with serial port) works only if the baud rate of the instrument and that of the computer are the same.**

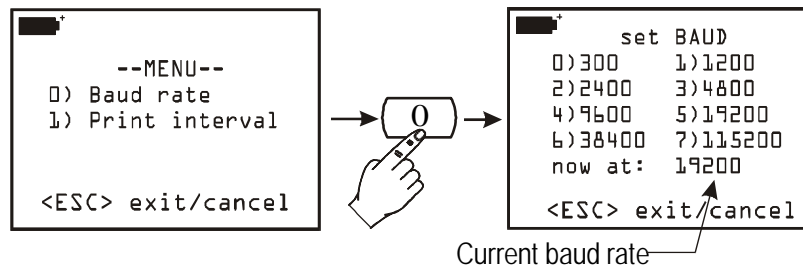

#### 4-1) Print Interval

This represents the printing interval in seconds and may be set from 1 to 3600 seconds (or 1 hour). If the baud rate has been set at 300, the minimum interval is 5 seconds. Set the desired

interval and then confirm it with the <ENTER> key. Press <ESC> > to quit without making any changes.

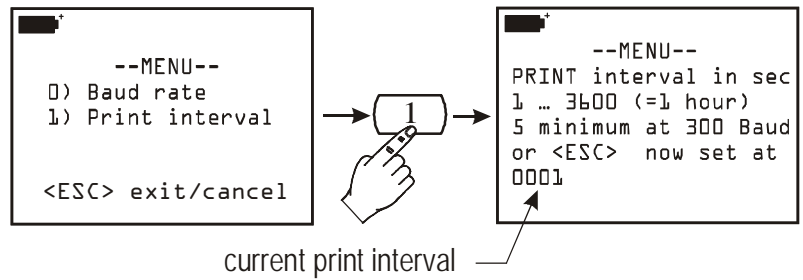

This parameter influences the functions of the immediate printing of data: *Screen*, *RCD+* and *Rawdata* (see the functions “*Screen*”, “*RCD+*” and “*ALL*” from p.90)

## 5) CALIBRATE

Manages the calibration functions of the probes connected to the instrument. The probe+instrument calibration function may be protected by a password (see the function on page 15 “1-1) Reserved function lock”). If user level is enabled, when you enter the function with the <Enter> key a list of the probes connected to the instrument inputs appears: each probe is identified by its serial number and by the type of measurement. Selecting one by pressing the number next to each probe takes you to the calibration menu.

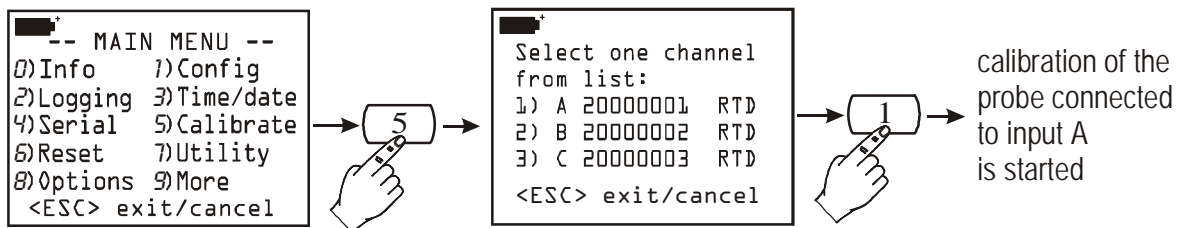

Each type of probe has its own calibration procedure: see the description of the various probes and the respective calibration operations from p.28.

Instead, if user level is disabled, it will not be possible to calibrate any probe; in this case the following message will appear: “Sorry! This operation is RESERVED”. Press <ESC/CLR> to quit. To proceed with calibration you must enable user level by typing in the user password and then repeat the operation.

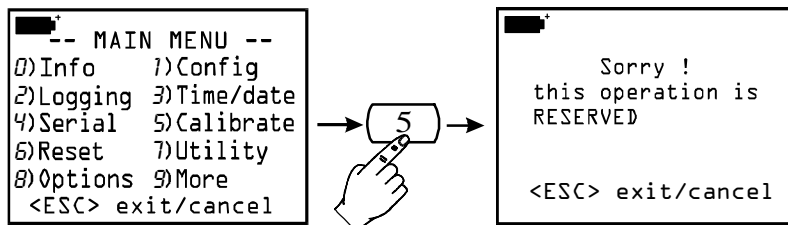

## 6) RESET

With this command the instrument parameters are returned to default conditions. The variables that are reset are the date, time, the configurable options protected by password, the baud rate for serial communication, the print options and the logging functions.

After entering the RESET function with the key <6/RCD>, press <ENTER> to confirm or <ESC/CLR> to cancel the operation.

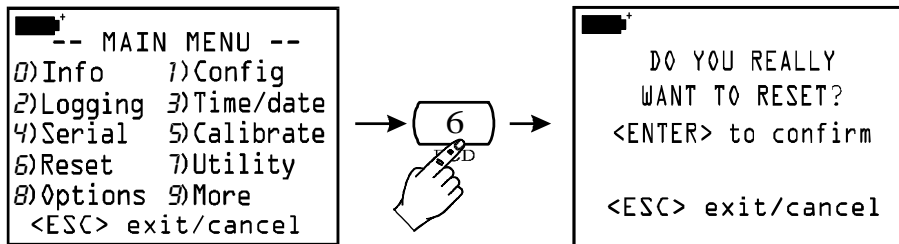

## 7) UTILITY (INSTRUMENTS)

It makes a list of calculating instruments and functions used by some modules connectable to the instrument.

### 7-1) Area Calculations

It is used for flow measurements: for example with hot wire anemometric probes, as well as with vane and Pitot tube probes.

Flow measurement requires to know the pipe area or the area of the outlet/vent vertically positioned with respect to the flow: to set this parameter, select item “1) Area calculations”.

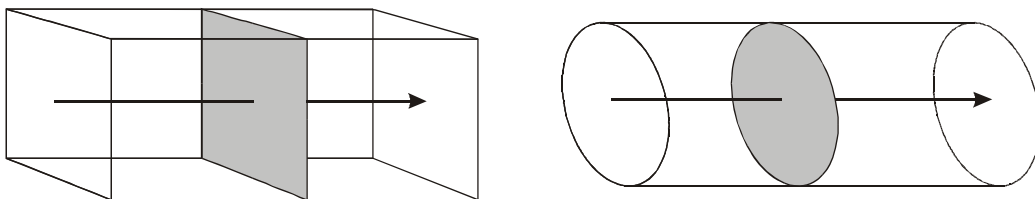

**The unit of measurement to be used is  $\text{cm}^2$  for the metric system, and  $\text{ft}^2$  for the English one:** in this case, the instrument will use the conversion into  $\text{cm}^2$  for internal calculations.

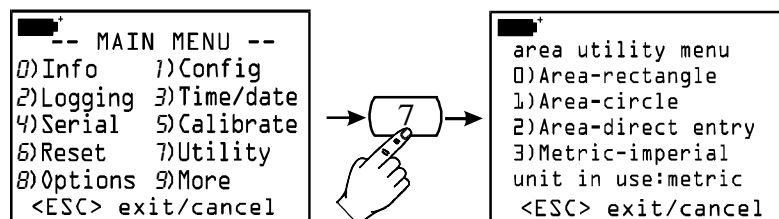

Select an item of the menu, according to the geometric shape of the surface of air inlets or vents:

- <0> if the surface is square or rectangular
- <1> if the surface is circular
- <2> if you already know the surface area.

Use the key <3> to switch the units of measurement from metric to English and vice versa.



*Rectangular Surface:*

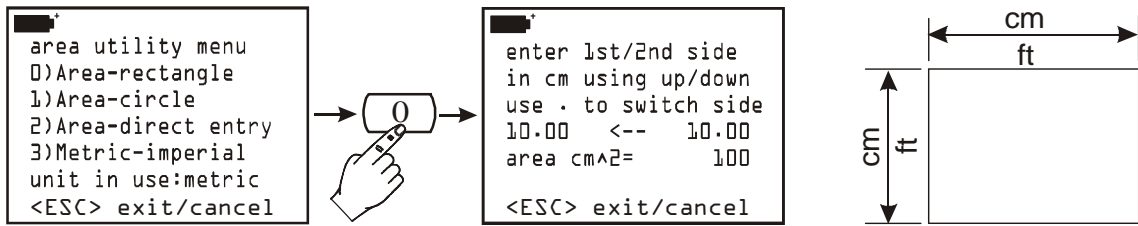

Press <0> to open the submenu: use the arrows to increase or decrease the measure of the first side (**either in cm or in ft**); then press “.” (decimal point) to select the second side and the arrows to set its length. As you change the length of the two sides, the instrument will show the area value in  $\text{cm}^2$ ; should the English system be active, the area will be indicated both in  $\text{ft}^2$  and in  $\text{cm}^2$ . Press Enter to confirm.

*Circular Surface:*

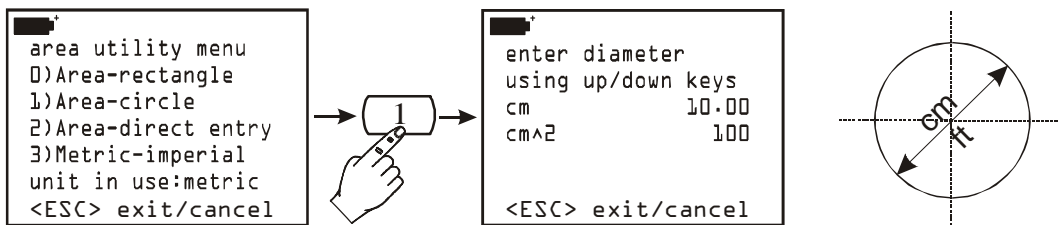

Enter the value of the circular surface diameter using the Up and Down arrows. **The value has to be expressed either in cm or in ft**, according to the selected unit of measurement (metric or English system). The instrument will display the area value depending on the selected units: should the English system be active, the area will be indicated both in  $\text{ft}^2$  and in  $\text{cm}^2$ . Press Enter to confirm.

*Generic Surface:*

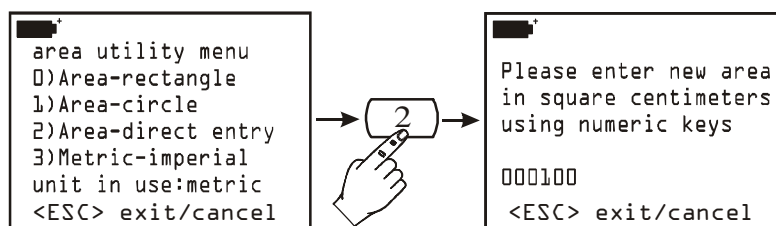

Use the numeric keys to enter the value of the area; **the area value has to be selected between 100 and 100000 $\text{cm}^2$ , that is between 0.01 and 10 $\text{m}^2$ . If the area value exceeds the a.m. limits, the instrument will provide an error signal and will set the default value (100 $\text{cm}^2$ ).**

## 8) OPTIONS

It makes a list of calculating parameters used by some of the modules connectable to the instrument.

### 8-1) Comp. Temp. Select (Selection of Compensating Temperature)

It selects the source of temperature compensation, where provided (i.e.: for air velocity, pH, conductivity measurements, etc).

```
0)Ti source
1)Probe A source
2)Probe B source
3)Probe C source
4) Manual entry
Now = 4
```

Press <0> to select the instrument internal temperature (Ti) as source for compensation. Use the keys <1/MATH>, <2/LOG> and <3/TIME> to view the temperature detected by the probe connected either to input A, B or C, respectively. To enter the temperature value manually, when no probe is available, select <4/SERIAL\_OUT> and press <ENTER> as indicated in the window below:

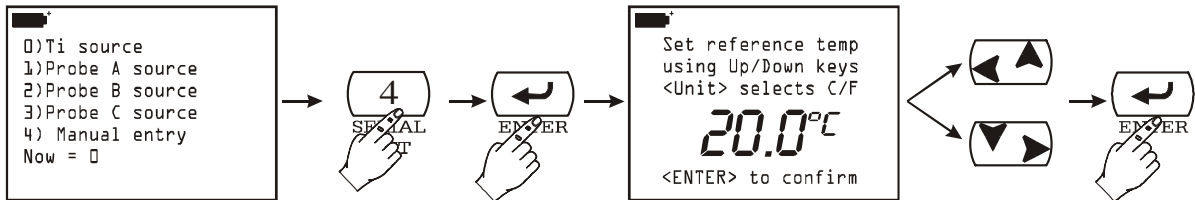

Use the Up (▲) and Down (▼) arrows to enter the temperature value directly and press <ENTER> to confirm. To switch from Celsius to Fahrenheit and vice versa, press <9/UNIT>.

### 8-2) Flow Averaging Time

When measuring flows, the value detected by the instrument is quite unsteady because of air turbulences. For this reason, the instrument will employ the average value coming from the last **n** measurements (moving or current average). The “n” range goes from 1 to 100.

In the following chart, curve 1 represents the trend of velocity measurements acquired by the instrument over time. Curve 2 represents the moving average displayed by the instrument after setting the n parameter “Flow averaging time” at 3. As shown by the chart, the time trend of curve 2 is less affected by amplitude changes than curve 1.

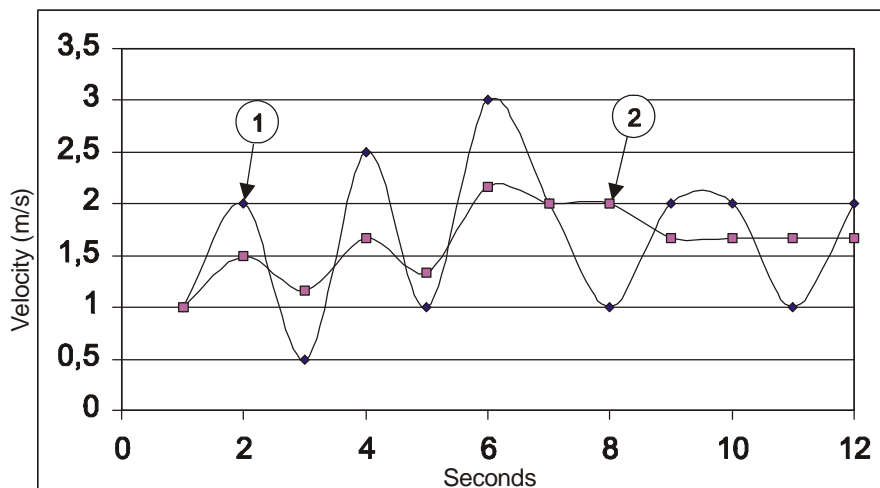

*Effects of moving average on velocity and flow measurement with n=3.*

Select “8) Options” from the menu, then “2) Flow averaging time”: select a number between 001 and 100 from keyboard and press <ENTER> to confirm.

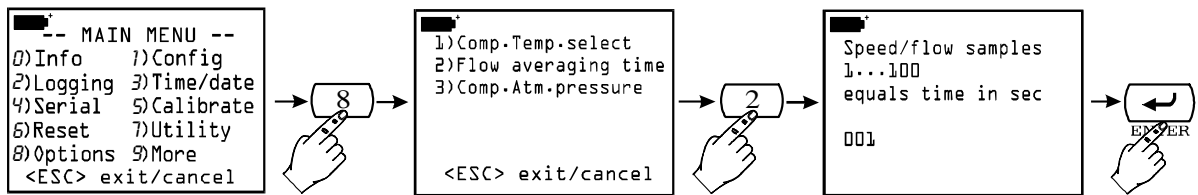

### 8-3) Comp. Atm. pressure (Atmospheric Pressure Compensation)

It selects the compensation source for atmospheric pressure. An example: the Pitot tube for air velocity measurements.

Press either <1/MATH>, <2/LOG> or <3/TIME> to select the atmospheric pressure detected by the modules connected to A, B or C modules, respectively. Press <4/SERIAL\_OUT>, and then <ENTER>, to display the window where the pressure value can be set manually, as indicated by the figure below:

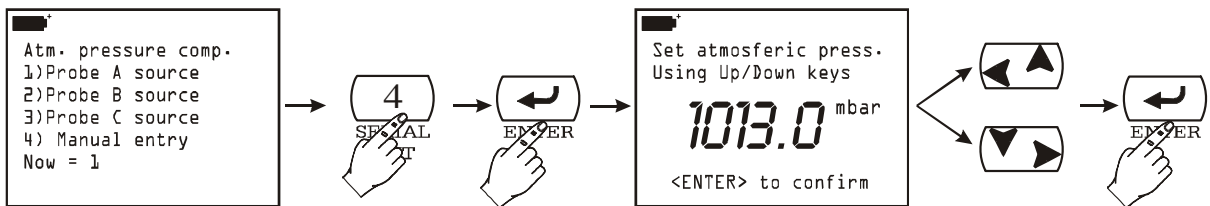

Use the Up (▲) and Down (▼) arrows to enter the pressure value directly. Then press <ENTER> to confirm.

## THE PROBES

The probes of the graphic datalogger are equipped with an "intelligent" module which acts as an interface between the sensor in the probe and the multifunction instrument. Inside this module there is a microprocessor circuit with a permanent memory which performs various function:

- it enables the datalogger to recognise the type of probe connected: Pt25, Pt100, Pt500, thermocouple, humidity probe, pressure probe, anemometric probe;
- it memorises the probe calibration data: in this way it can be used on any one of the instrument's three inputs, or on a second instrument, without having to be recalibrated;
- it recognises the instrument with which it was calibrated (user calibration);
- it maintains the factory calibration data and those of the last calibration done by the user, which may be protected by a password. If enabled, the user can choose which calibration to use for each of the probes connected to the instrument;
- it memorises a serial number which allows the unmistakable identification of the probe. This is useful if several probes of the same type are being used at the same time.

The recognition of the probes takes place when the instrument is switched, after reset (function "6) Reset" of the Menu) and during calibration, when proceeding with calibration of the probes connected to the inputs (*see the general section on calibration on p.23 and the individual models in the next chapter*).

The instrument memorises which probes are connected to its inputs: if on switching on it finds that there has been a variation, for example because a probe has been disconnected, it notifies the operator with the message: "WARNING! CHANGE OF PROBES DETECTED –Press NOW any key to choose settings or wait to self-config ". When any key is pressed within 3 seconds, a menu is opened in which the instrument configuration parameters may be modified. If you do not consider it necessary to modify them, it is sufficient to wait 3 seconds to return to the standard measuring conditions. If you disconnect a module, the notice "COM FAILURE" (communication error) will appear, indicating that there is no communication between the module and the instrument: insert the probe again in the same input to restore correct measurement conditions.

For further details on the probe, see the paragraphs below concerning the individual measurements.

### Pt100 TEMPERATURE PROBES

The DO9847 accepts at input Platinum temperature probes with a resistance from 25 $\Omega$  to 500 $\Omega$ .

Platinum probes have 4-wire connections, the energising current is chosen in such a way as to minimize the effects of self-heating of the sensor.

All Pt100 probes are calibrated in the factory: the user can choose whether to use this calibration or to make a new one and even protect it with a password (*see the heading "1-3) Probe options" on p.16*).

The user can choose what unit of measurement to use for viewing and printing from among those allowed with Pt100 probes °C, °F or °K (see the instructions for selecting the unit of measurement on p.10).

In the appendix of the instructions manual there is a description of the mathematical function used by the instrument for finding the temperature as a function of the sensor resistance and the meaning of the coefficients  $R_0$ ,  $\alpha$ ,  $\delta$  and  $\beta$ : *see p.116*.

## Calibration of Pt100 Probes

The calibration procedure is accessible from the Menu: key <MENU> → Function 5) **Calibrate** (on p.23 there is a definition of the options of the Calibration function applicable to all types of probes).

- 1) **Set default Pt100**: this function transfers the nominal values of the Pt100 sensor into the memory of the selected probe (to be used if the probe has not been calibrated and is not possible to perform calibration).
- 2) **Calibrate probe**: this function is used to calibrate the probe on one, two or three points: one point is necessarily 0°C, the second one has to be selected from 95°C to 105°C and the third one from 150 and 400°C.

Calibration on two or three points is not necessary: when some points are lacking, the instrument will use for those points the value stored in the previous calibration or, if no previous value is available, it will use the factory calibration value (see *Probe Options* on p.16).

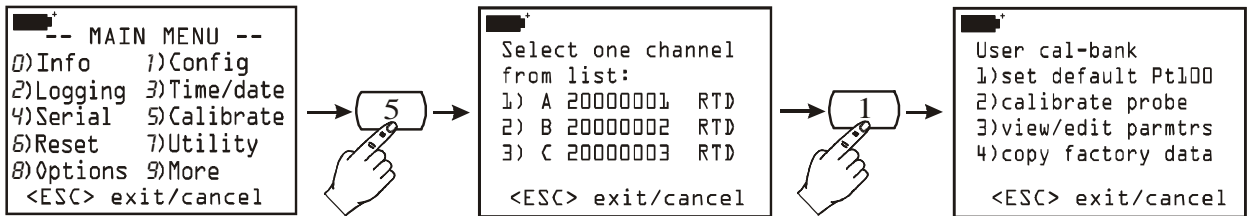

Calibration of the probe connected to input A is started

### Procedure:

The following picture shows the different steps to carry out a calibration on three points.

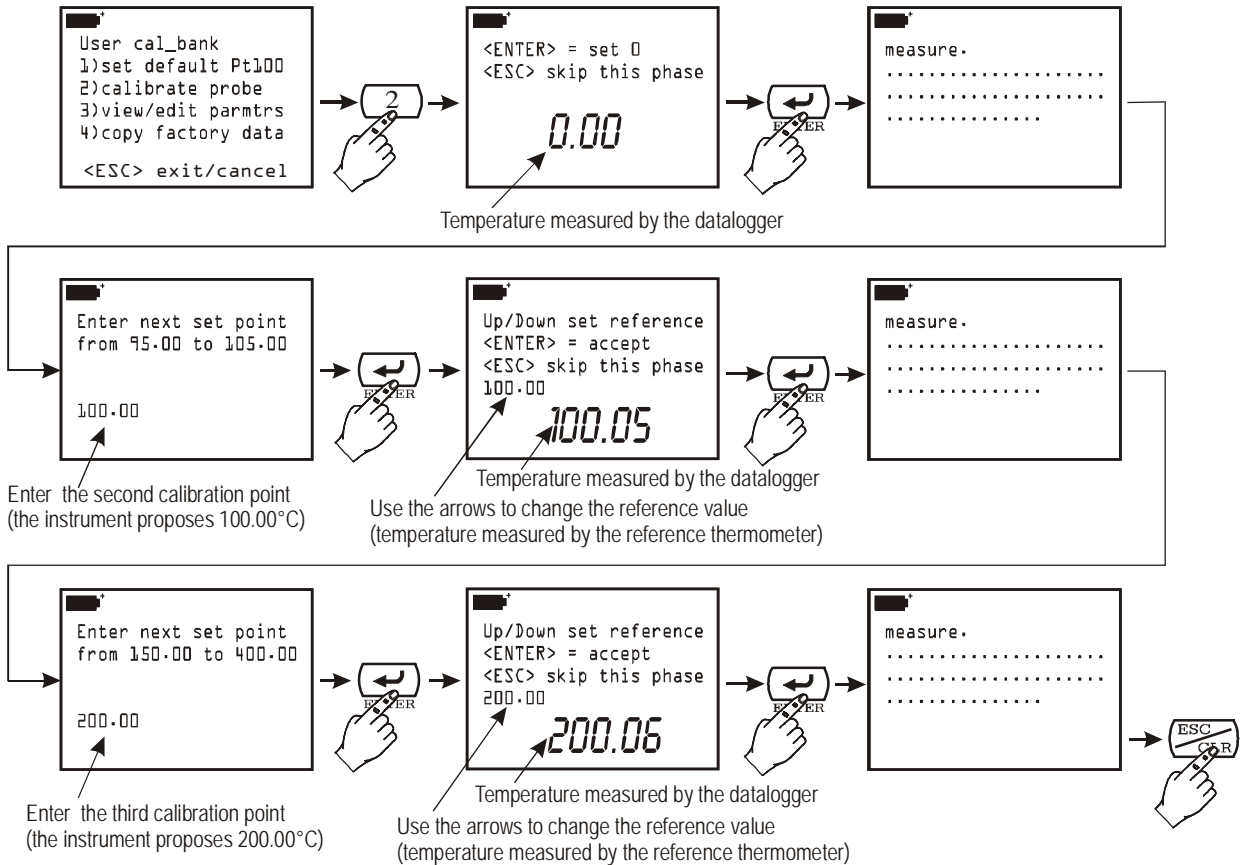

**Calibration of 0°C:** insert the probe in a bath at 0°C. The instrument display shows the temperature value that it is reading: when the reading has stabilised, press <ENTER> to confirm the point at 0°C for the reference sample probe. Press <ESC> to move on to the second point without calibrating the first point at 0°C.

**Second and third calibration point:** the instrument proposes 100.00°C as second calibration point; if a different calibration value is necessary, change it and confirm by pressing <ENTER>. At this point the instrument display shows the temperature value that it is reading and the calibration value: the latter may be altered using the arrows. When the values indicated by the instrument are the same as those of the reference probe, press <ENTER> to confirm. If you do not want to perform this step, press <ESC>. The instrument then proposes 200.00°C as third point: follow the same procedure as for the second point. Press <ENTER> to confirm or <ESC> to cancel the current step. Calibration is now completed.

**3) View/edit parameters:** with this function it is possible to view and/or modify the coefficients that describe the curve  $T=f(R)$  used by the programme for finding the temperature as a function of the resistance of the PRT sensor PRT (see the appendix for details).

The following example shows how to modify the parameter  $R_0$  of the curve of the Pt100 sensor connected to input A of the instrument. For convenience of setting, this parameter is shown in thousandths of an ohm, so 100,000Ω is indicated as 100000mΩ. Insert the new value and press <ENTER> to confirm it. If you do not want to correct the value but only view it, press <ESC/CLR> to quit without making any variations.

The other parameters of the curve ( $\alpha$ ,  $\delta$  and  $\beta$ ) are shown using only the significant figures of the respective values: for example  $\alpha = 0.00385055$  is shown as 385055 since only this part of the coefficient can be varied. In the same way  $\delta = 1.499785$  is shown as 1499785 (without decimal point) and  $\beta = 0.10863$  as 10863.

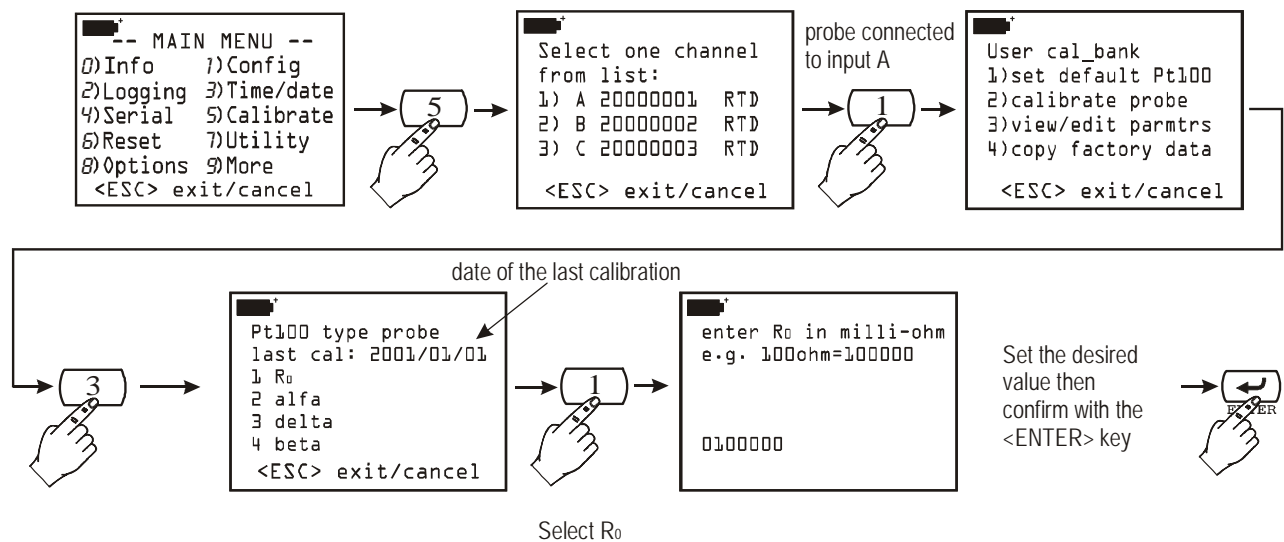

**4) Copy Factory Data:** this function transfers the memorised factory calibration data into the probe. It is useful when you notice that incorrect calibration data have entered (for example, due to incorrectly performed calibration) and you are temporarily unable to perform a new calibration.

**Electronic module TP471 SICRAM for PRT sensors without probe.**



The TP471 electronic module is intended for operation with PRT sensors with a 4-wire connection. Temperature probes with a Platinum resistance with  $R(0^{\circ}\text{C}) = \text{Pt } 25 \Omega, 100 \Omega \text{ or } 500 \Omega$  may be used.

Below are given the instructions for connecting the probe to the module.

The module is supplied complete with a fairlead and grommet for wires with a maximum diameter of 5m. To open the module in order to connect a probe, proceed as follows: unscrew the fairlead and extract the grommet, remove the identification label, unscrew the ring nut on the opposite side of the module as shown in the figure:

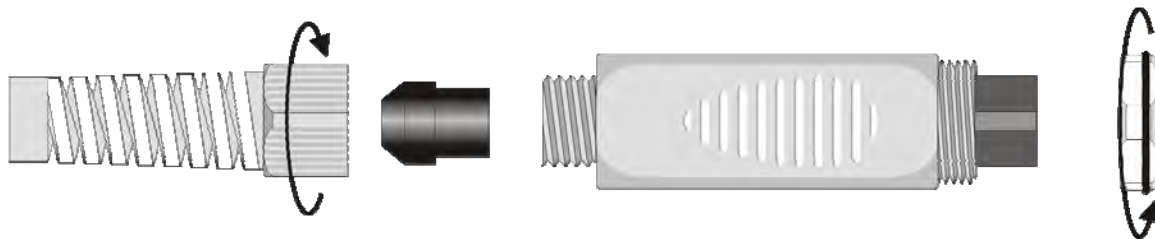

Open the two shells of the module: inside is the printed circuit to which the PRT probe must be connected. The connections are shown in the enlargement in the figure:

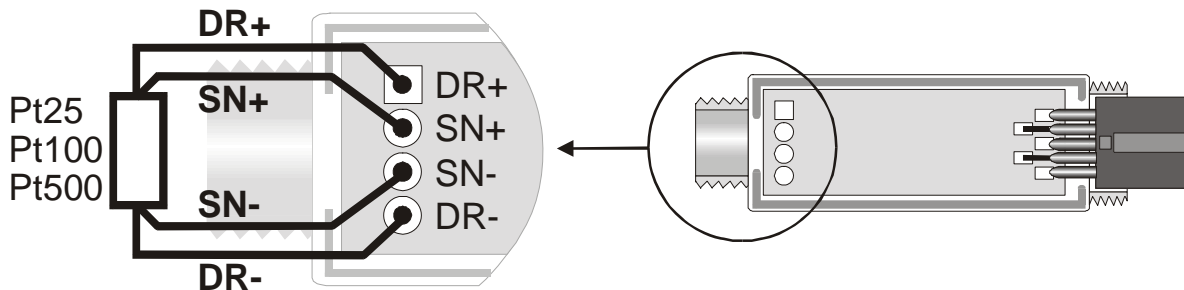

Before making the weld, pass the probe cable through the fairlead and the grommet. Take care that the welds are clean and made in a workmanlike manner. Once the welding operation has been completed, close the two shells, insert the grommet in the module, screw on the fairlead and the ring nut. Take care that the cable does not get twisted round the fairlead. At this point the probe is ready.

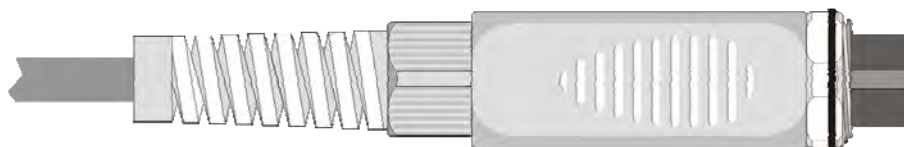

Before you can use the probe it must be calibrated (*see from p.29 onward the various calibration procedures*)

If you know the Callendar – Van Dusen parameters of the probe, these can be inserted in the memory, thus obtaining a calibrated probe (*See the paragraph “View/edit parameters” on p.30*).

## THERMOCOUPLE TEMPERATURE PROBES

The DO9847 accepts at input thermocouple temperature probes type K, J, T, E, R, S, B and N. The probe is composed of a module with a DIN 8-pole connector for connection to the inputs of the datalogger, a microprocessor circuit with permanent memory and, depending on the models, one or two thermocouple connectors. There are modules with or without the integrated temperature sensor for compensating the environment temperature. By pressing the function keys F1, F2 and F3 corresponding to the indications Xsel, Ysel and Zsel, it is possible to view the temperatures measured by the thermocouple probes connected to the inputs: for example, if a compensated double module (TP471D1) is connected to input A, A1 represents the temperature of probe 1, A2 the temperature of probe 2 and A3 the temperature of the cold junction; on the other hand, if a compensated single module (TP471D) is connected, A1 represents the temperature of the thermocouple and A3 that of the cold junction.

The thermocouple probes purchased with the respective module are calibrated in the factory: the user can choose whether to use this calibration or to make a new one and even protect it with a password.

The user can choose what unit of measurement to use for viewing and printing from among those allowed with thermocouple probes: °C, °F or K (see the instructions for selecting the unit of measurement on p.10).

### Calibration of Thermocouple Probes

For calibration, one point for offset correction is contemplated and up to three points for compensating amplification. **The two probes connected to the double module (TP471D1) must be calibrated at the same time.**

The temperature of the cold joint is measured by a KTY<sup>(1)</sup> sensor situated inside the probe module. The temperature supplied by the sensor is factory calibrated.

### Selecting the Type of Thermocouple

To start calibration, open the instrument menu and select "5) Calibrate": the probes connected to the instrument inputs will be viewed. Once you have chosen the input to which the module to be calibrated is connected, access the menu for selecting the type of thermocouple.

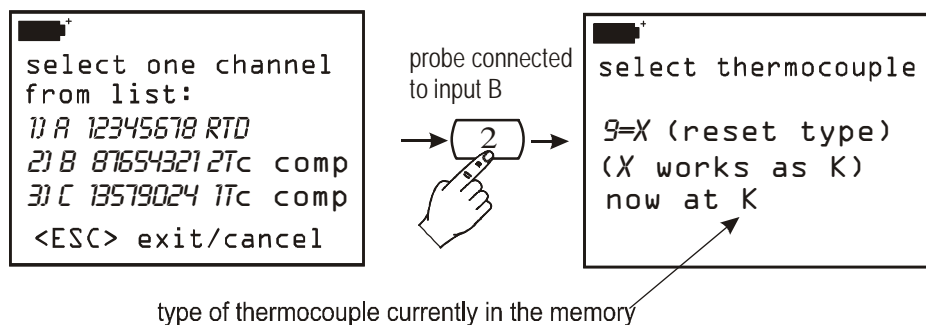

Before changing the type of thermocouple you must first delete the one present in the memory and then insert the new type. In the example shown above, the probe is type K. Press the <ENTER> key to confirm or press the key <9/UNIT> to change it. When <9/UNIT> is pressed, the thermocouple calibration data are brought back to the default value.

Press <ENTER> to proceed or <ESC/CLR> to cancel the reset operation.

<sup>(1)</sup>The KTY sensor used has a resistance of 1000 Ohm at 25°C



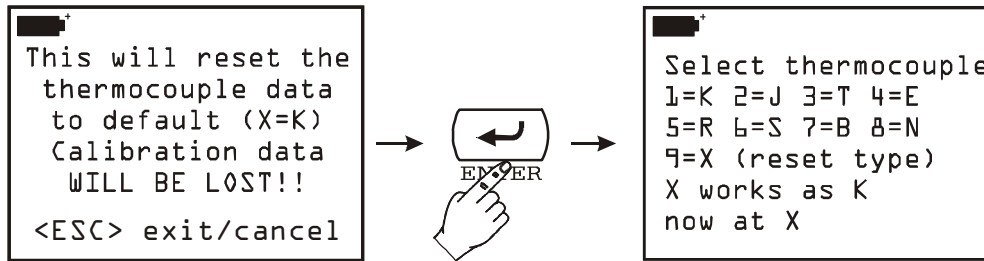

At this point it is possible to insert the type of thermocouple by pressing the corresponding numerical key: for example, if you want to set thermocouple type J, press the numerical key <2/LOG> and confirm with the <ENTER> key when the next screen appears.

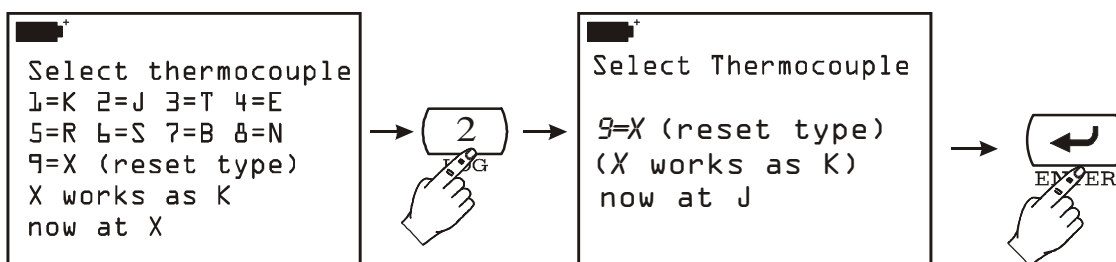

## Offset Compensation

```

<ENTER> = proceed to
          Zero Point
          calibration
or skip
<ESC> exit/cancel

```

Press <ESC/CLR> to skip this step. Bring the calibration bath to the temperature used for compensating offset at 0°C and immerse the probe in it (or the two probes of the double module). Wait until the probes have reached the bath temperature and then press <ENTER>. The following screen appears:

```

Zero Point
Up/Down set Target
<ENTER> calibrates.
<ESC> to next point
Target:      0.0°C
Chan A:      0.55°C
Chan B:      0.30°C

```

Wait until the temperatures indicated for channels A and B have stabilised. Using the *Up* and *Down* arrows correct the calibration value proposed by the instrument (Target) and make it coincide with the bath temperature measured by the reference thermometer. To confirm, press <ENTER>: in this way the temperature values of the thermocouple probe (or of the two probes if the double module is connected) automatically go to the value indicated as the “Target” and

measured by the reference thermometer. Move on to the next point or press <ESC/CLR> to end calibration.

### Second Calibration Point

Up to three points are calibrated for compensating probe gain. The three points may be chosen at will **as long as they are in increasing order**. Moreover, if you do not think it necessary to perform calibration on all three points, it is possible to calibrate only the first and not the other two (using the <ESC/CLR> key), or you can do the first and the second but not the third point.

```

██████
<ENTER> = proceed to
          First Point
          calibration
or skip
<ESC> exit/cancel

```

Bring the calibrating oven to the temperature contemplated for compensating the gain of the second point and immerse the probe in it (or the two probes of the double module). Wait until the probes have reached the oven temperature and then press <ENTER>. The following screen appears:

```

██████
          First Point
Up/Down set Target
<ENTER> calibrates.
<ESC> to next point
Target:      100.0°C
Chan A:      100.55°C
Chan B:      100.30°C

```

The instrument proposes the temperatures read by the input channels A and B and an estimated value of the oven temperature: in the figure above the instrument has found the temperatures 100.55°C and 100.30°C for channels A and B and has proposed, as oven temperature, 100.0°C. Wait until the temperatures indicated for channels A and B have stabilised. Using the *Up* and *Down* arrows correct the calibration value proposed by the instrument (Target) and make it coincide with the oven temperature measured by the reference thermometer. To confirm, press <ENTER>: the indication of the value of the probe (or of the two probes) being calibrated will coincide with the temperature indicated by the instrument (Target) and with the temperature measured by the reference thermometer. Move on to the next point or press <ESC/CLR> to end calibration.

### Third and Fourth Calibration Points

The procedures for calibrating the third and the fourth point are identical to those for the second point: ensure that you use increasing oven temperatures. Press <ESC/CLR> if you do not want to calibrate these points.

## RELATIVE HUMIDITY PROBES

The humidity probes for the DO9847 are of the combined humidity and temperature type: the humidity sensor is of the capacitive type, the temperature sensor is a Pt100. The probes are equipped with a module with a DIN 8-pole connector inside which is a microprocessor circuit with a permanent memory which stores the calibration data.

By pressing the function keys F1, F2 and F3 corresponding to the indications Xsel, Ysel and Zsel, it is possible to view the humidity (or one of the derived quantities, as explained below), the temperature (or one of the derived quantities) detected by the combined probe connected to the inputs of the instrument, as well as some quality indices: if a combined probe is connected to input A, A1 represents humidity, A2 represents the temperature measured by the Pt100 sensor of the probe and A3 Discomfort Index and Net Index (see paragraph *Humidity and Quality Indices (Comfort indices)* at page 41 for a detailed description of index meaning).

The instrument measures the relative humidity, the temperature and, starting from a fixed barometric pressure value of 1013.25mbar, calculates the following six derived quantities:

1. Pvp partial vapour pressure (hPa)
2. g/kg grams of vapour in a kilogram of dry air
3. g/m<sup>3</sup> grams of vapour in a cubic metre of dry air
4. J/gr enthalpy
5. Td dew point (°C)
6. Tw wet bulb temperature (°C)
7. Td dew point (°F)
8. Tw wet bulb temperature (°F)
9. Svp saturated vapour pressure (hPa)
10. DiscIndx Discomfort Index
11. NetIndx Net Index

The first 8 variables, together with relative humidity, form a group of nine variables identified on the display with the number 1: A1, B1 or C1 depending on whether the relative probe is connected respectively to input A, B or C of the instrument.

The group composed of the temperature of the Pt100 sensor and of the Svp variable is identified on the display with the number 2: A2, B2 or C2.

Relative humidity, the Discomfort Index and the Net Index are listed in A3 (as well as in B3 or in C3).

Selection within each of the three groups is made with the key <9/UNIT> as shown in the example below.

Suppose that a combined humidity and temperature probe is connected to input A of the instrument and you want to show the dew point (Td in °C) on the first line of the display, the saturated vapour pressure (svp) on the second line and the Net index on the third one.

### Procedure:

if the display is not set to view A1, A2 and A3 variables, press F1 (Xsel) until you see the indication **A1** on the first line, press key F2 (Ysel) to see the indication **A2** on the second line and F3 (Zsel) to see the indication **A3** on the third line. At this point, press the key <9/UNIT>:

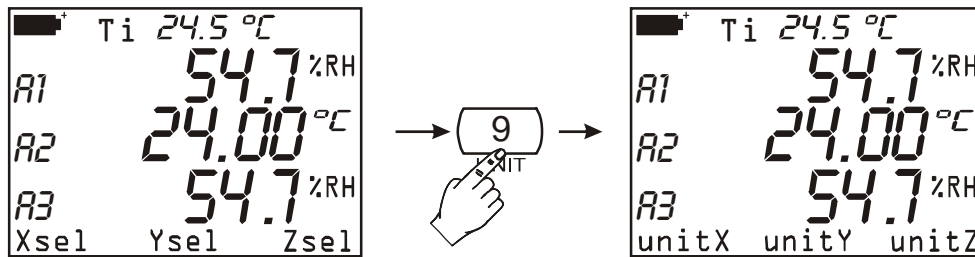

Xsel, Ysel and Zsel items available in the commands bar are replaced by unitX, unitY and unitZ items.

Press the function key F1 (unitX) repeatedly to select the Td (°C) variable included in the first group of variables: %RH, Pvp, g/kg, g/m<sup>3</sup>, J/gr, Td (°C), Tw (°C), Td (°F), Tw (°F).

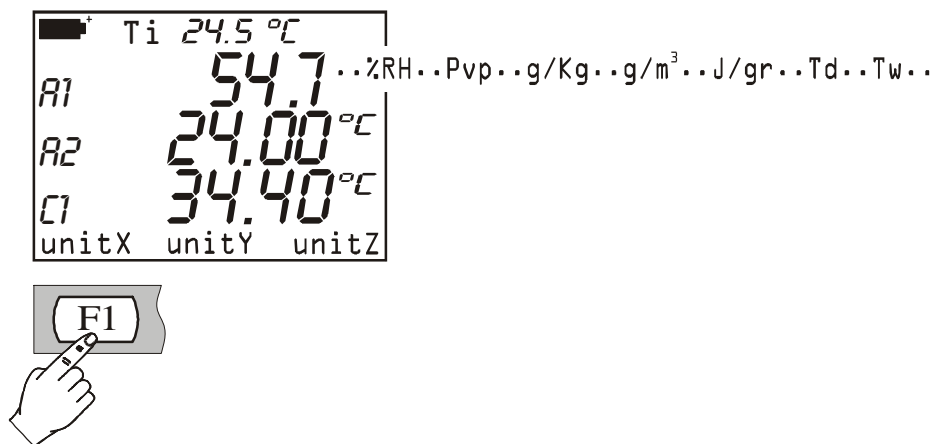

Accordingly, for the second line of the display, press F2 (function key) to select the Svp variable included in the list of variables of the second group (Pt100 temperature in °C, °F or °K and Svp) and press F3 to choose the *Net Index* variable included in the third group (%RH, Discomfort Index or Net Index).

The measurement with the combined probe is carried out by introducing the probe in the area where you want to find the parameters. Keep the probe far away from elements that could interfere with the measurement such as sources of heat or cold, walls or draughts, etc. Avoid extremes of temperature which give rise to condensation. The reading where there are no large differences in temperature is almost immediate; instead, in the presence of small differences, you must wait until the probes and the probe body have reached thermal equilibrium, otherwise there is radiance or heat absorption on the relative humidity sensor: all this leads to an incorrect measurement since, as has been said above, temperature influences relative humidity.

### **Calibration of the Combined Humidity/Temperature Probe**

For correct calibration of the probes it is fundamental to know and respect the physical phenomena on which the measurement is based: for this reason it is recommended to scrupulously follow the instructions below and to perform new calibrations only if you are in possession of suitable technical knowledge.

The calibration procedure is accessible from the Menu: key <MENU> → Function 5) **Calibrate** (on p.23 there is a definition of the options of the Calibration function applicable to all types of probes). When you enter the function with the <Enter> key a list of all the probes connected to the instrument inputs appears: select the humidity/temperature probe to be calibrated.

For combined probes, two distinct calibration procedures are contemplated: **one for the temperature sensor and one for the relative humidity sensor.**

### *Calibration of the Pt100 or thermocouple Temperature Sensor*

Save the case in which the temperature sensor is working in a particularly hostile or corrosive atmosphere, or where, by mistake, its calibration has been endangered, the temperature probe does not normally require recalibration: it is advised to assess the need for new calibration carefully before taking action.

```
temp cal mode
1) Set standard Pt100
2) Cal. sensor temp
```

```
temp cal mode
2) Cal. sensor temp
```

The calibration menu contemplates two methods for calibrating the temperature sensor:

- 1) **Set standard Pt100 (only for Pt100 sensor temperature probes)**: returns the sensor parameters to the default values of the standard Pt100 curve. When the key <1/MATH> is pressed the nominal values of the Pt100 sensor are copied into the memory of the selected probe. This function is used if the probe has not been calibrated and it is not possible to perform calibration of the sensor. To quit the function without making any changes, press <ESC/CLR>.
- 2) **Cal. sensor temp (for Pt100 or thermocouple sensor temperature probes)**: requires a calibration oven and a reference thermometer. Press the key <2/LOG>: the temperature measurement taken by the Pt100 or TC (thermocouple) sensor will appear. Insert the probe to be calibrated together with the probe of the reference thermometer in a calibration oven (**respecting the range of operation of the RH probe**). the probe must be protected against any liquid in the oven. The calibration point may have any value within the working range of the RH probe, since with this operation an alignment is made with the theoretical curve. Wait until the measurement has stabilised: if necessary use the arrows to correct the value indicated by the instrument, causing it to coincide with the value found by the reference thermometer. Press the <ENTER> key to confirm.

### *Calibration of the Relative Humidity Sensor*

```
RH cal mode
0) Full calibration
1) 75% tune-up
2) 33% tune-up
3) 11% tune-up
<ESC> exit/cancel (2)
```

The menu for calibrating the RH sensor proposes four versions: the first refers to complete calibration on 2 or 3 points; the other three versions are used for aligning a single point at 75%, 33% and 11% RH.

<sup>(2)</sup> Tune-up = adjustment, fine regulation

## 0) Full Calibration

This calibration procedure erases the data of the previous calibrations. **For a correct calibration of the probe the first point must be at 75%RH** and the second point at 33%RH. On concluding the second point at 33%RH, the instrument also proposes a third calibration point at 11%RH: if you do not want to use it, it is sufficient to press the <ESC/CLR> key to quit without making this last correction.

To complete correct calibration it is very important that the probe and the saturated solutions be at the same temperature and that the temperature be as stable as possible throughout calibration.

### Calibration sequence:

1. Unscrew the sensor protection at the end of the probe.
2. In its place, right down to the base, screw on the perforated cap with its threaded ring nut (these come in different sizes depending on the type of probe).
3. Open the cap of the 75%RH saturated solution.
4. Check that there are no drops of solution inside the measuring chamber; if there are any, dry them with absorbent paper.
5. Insert the probe in the container, ensuring that the cap with the probe goes down to the base. **The measuring chamber must be perfectly closed, otherwise it will not become saturated:** it is fundamental that there be no possibility of air from the outside getting into the chamber.
6. **Wait at least 30 minutes.**
7. Press the key <0> to select the calibration version “**0) Full calibration**”; a message will appear reminding you that, if you continue, all the data referring to previous calibrations will be erased. Press <ENTER> to continue or <ESC/CLR> to cancel the operation without making any changes.
8. The following screen will appear:

```
+/- set RH    75.0
<REL> to apply

T=  24.55°C
RH=  0.0%RH
<ENTER> = accept
<ESC> exit/cancel
```

using the arrow keys (*Up and Down*) it is possible to correct the value of the saturated solution with respect to the 75.0 proposed by the instrument. The temperature is the one measured by the Pt100 or TC sensor, the initial relative humidity value is 0.0%RH since the data of the previous calibrations have been erased. To confirm the first calibration point you can use the <REL> key or the <ENTER> key: with the first the correction is “applied” remaining in the same screen; with the <ENTER> key you move directly on to the screen for the calibration of 33%RH.

The <REL> key is useful when you want confirmation of the correction made before going any farther: to move on to the second point at 33%RH press the <ENTER> key.

9. Take the probe out of the container with 75%RH, close the container with its cap and open the container of the saturated solution with 33%RH. Check that there are no drops of solution inside; if there are any, dry them with absorbent paper.
10. Insert the probe in the container, ensuring that the probe and the cap goes perfectly down to the base.
11. **Wait at least 30 minutes.**

12. If necessary, correct the value of the saturated solution with the arrows. The instrument will indicate the temperature measured by the sensor: to complete correct calibration it is important that this be kept within  $\pm 1^{\circ}\text{C}$  of the temperature used to calibrate the first point at 75%RH. The RH measurement taken by the instrument is not complete until the second calibration point has been done. When <REL> is pressed the instrument will propose the value measured and compensated in temperature: this will be 33%RH if the probe and the saturated solution are at  $20^{\circ}\text{C}$ . Press <ENTER> to continue.
13. Take the probe out of the container with 33%RH, close the container with its cap.
14. Having reached this point it is possible to proceed with the third point at 11%RH or to conclude calibration having calibrated the probe on the two points at 75 and 33%RH. Press <ESC/CLR> to conclude or go on to the next step.
15. Open the container with the 11%RH saturated solution. Check that there are no drops of solution inside; if there are any, dry them with absorbent paper.
16. Insert the probe in the container, ensuring that the probe and the cap go perfectly down to the base. The measuring chamber must be perfectly closed, otherwise it will not become saturated.
17. **Wait at least 30 minutes.**
18. If necessary, correct the value of the saturated solution with the arrows. The instrument will indicate the temperature measured by the sensor: keep it within  $\pm 1^{\circ}\text{C}$  of the temperature used to calibrate the first two points. When <REL> is pressed the instrument will propose the value measured and compensated in temperature: this will be 11.3%RH if the probe and the saturated solution are at  $20^{\circ}\text{C}$ . Press <ENTER> to conclude calibration.
19. Remove the probe from the container. Close the container with its cap.
20. Unscrew the ring nut with the cap, screw on the sensor protection. This operation concludes calibration.

**1) 75% tune-up (regulation at 75%RH)**

**2) 33% tune-up (regulation at 33%RH)**

**3) 11% tune-up (regulation at 11%RH)**

These functions give a correction of alignment around the three calibration points at 75, 33 and 11%RH.

What has been said about complete calibration also applies to these versions of partial calibrations. To complete correct calibration it is very important that the probe and the saturated solutions be at the same temperature and that the temperature be as stable as possible throughout calibration.

*Calibration sequence (reference is made to the point at 75%RH. For the other two points the procedure does not change):*

1. Unscrew the sensor protection at the end of the probe.
2. In its place, right down to the base, screw on the perforated cap with its threaded ring nut.
3. Open the cap of the 75% RH saturated solution.
4. Check that there are no drops of solution inside the measuring chamber; if there are any, dry them with absorbent paper.
5. Insert the probe in the container, ensuring that the cap with the probe goes down to the base. The measuring chamber must be perfectly closed, otherwise it will not become saturated: it is fundamental that there be no possibility of air from the outside getting into the chamber.
6. **Wait at least 30 minutes.**
7. Starting from the screen “**RH cal mode**” press the key <1/MATH> to start the tune-up function at 75%RH:

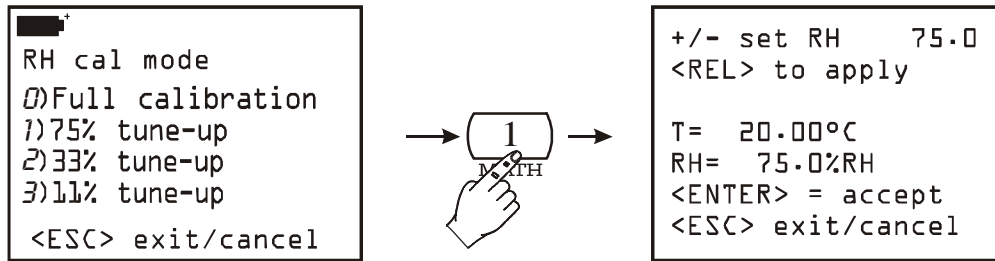

8. Using the *Up* and *Down* arrow keys it is possible to correct the value with respect to the saturated solution at 75.0 proposed by the instrument. The temperature is the one measured by the Pt100 or TC sensor. To confirm the calibration point you can use the <REL> key or the <ENTER> key. With the <REL> key the correction is “applied” remaining in the same screen: the instrument proposes the value measured and compensated in temperature. Use the <ENTER> key to confirm the value and quit the procedure. The <REL> key is useful when you want to have confirmation of the correction made or you want to repeat the operation before concluding. **After the <REL> key has been pressed, the instrument shows the relative humidity value found: this will be the same as the value of the saturated solution set or displayed by the instrument (first line of the display) if the probe and the saturated solution are at 20°C otherwise it will be corrected according to the temperature read.**
9. Take the probe out of the container. Close the container with its cap.
10. Unscrew the ring nut with the cap, screw on the sensor protection. This operation concludes calibration and alignment with a specific point of the RH.

### Important notes:

1. Do not touch the RH sensor with your hands
2. The base of the RH sensor is made of alumina, so it breaks very easily
3. During the entire calibration cycle, work as much as possible at a constant temperature; plastics are generally bad heat conductors, so it takes some time for them to reach thermal equilibrium
4. If satisfactory results are not obtained, check whether:
  - the sensor is faulty or corroded
  - during calibration the measurement chamber was not perfectly closed
  - the saturated solutions used are exhausted. A saturated solution at 11%RH or 33%RH is exhausted when it not longer contains salt between the two walls but only a dense liquid: in this case the chamber can no longer reach saturation. For saturated solutions at 75%RH check that the salt is not dry (crystallised): to reach saturation it must be damp.
5. Storage of the saturated solutions: saturated solutions must be kept, if possible, in the dark at a constant temperature of around 20°C with the container tightly closed in a dry place.



**Equilibrium Relative Humidity of Selected Saturated Salt Solutions from 0 to 100°C**

Temp °C	Lithium Chloride	Magnesium Chloride	Sodium Chloride
0	11.23 ± 0.54	33.66 ± 0.33	75.51 ± 0.34
5	11.26 ± 0.47	33.60 ± 0.28	75.65 ± 0.27
10	11.29 ± 0.41	33.47 ± 0.24	75.67 ± 0.22
15	11.30 ± 0.35	33.30 ± 0.21	75.61 ± 0.18
20	11.31 ± 0.31	33.07 ± 0.18	75.47 ± 0.14
25	11.30 ± 0.27	32.78 ± 0.16	75.29 ± 0.12
30	11.28 ± 0.24	32.44 ± 0.14	75.09 ± 0.11
35	11.25 ± 0.22	32.05 ± 0.13	74.87 ± 0.12
40	11.21 ± 0.21	31.60 ± 0.13	74.68 ± 0.13
45	11.16 ± 0.21	31.10 ± 0.13	74.52 ± 0.16
50	11.10 ± 0.22	30.54 ± 0.14	74.43 ± 0.19
55	11.03 ± 0.23	29.93 ± 0.16	74.41 ± 0.24
60	10.95 ± 0.26	29.26 ± 0.18	74.50 ± 0.30
65	10.86 ± 0.29	28.54 ± 0.21	74.71 ± 0.37
70	10.75 ± 0.33	27.77 ± 0.25	75.06 ± 0.45
75	10.64 ± 0.38	26.94 ± 0.29	75.58 ± 0.55
80	10.51 ± 0.44	26.05 ± 0.34	76.29 ± 0.65
85	10.38 ± 0.51	25.11 ± 0.39	
90	10.23 ± 0.59	24.12 ± 0.46	
95	10.07 ± 0.67	23.07 ± 0.52	
100	9.90 ± 0.77	21.97 ± 0.60	

**Humidity and Quality Indices (Comfort Indices)**

Everybody knows how environmental conditions affect the human feeling of good health: particular values of temperature, humidity and air velocity turn out to be unpleasant if not unbearable to most people. Whereas it is easy to quantify the relationship between the measurement of a single variable and its effects on human beings, it is much more difficult to provide an indication of the combined effect deriving from all of the variables.

For this reason, different valuation systems have been introduced to get the formulation of the climate quality indices (**Comfort Indices**).

The DO9847 provides two indices: **Discomfort Index** and **Net Index**. The first one depends on temperature and relative humidity only, while the second one is related to air velocity, as well.

These two indices can be displayed only if the instrument is connected to a temperature/humidity combined probe (such as, for example, an HP472AC probe). Discomfort Index and Net Index are included in the group of variables identified by number 3: A3, B3 or C3, according to whether the probe is connected either to A, B or C input, respectively. An example of instrument setup to display the Net Index is detailed on page 35.

The Net Index also depends on air velocity, as stated in the definition given in the following pages. If the instrument is connected to a hot-wire anemometric omni-directional probe (model AP471 S2), the air velocity measurement will be used to calculate the index. Should no probe be connected, the air velocity value will be considered zero and its contribution negligible.

### ***Discomfort Index (DI)***

It is defined as follows:

$$DI = 0.81 \cdot T + \frac{H}{100} \cdot (0.99 \cdot T - 14.3) + 46.3$$

where T = temperature in °C and  
H = relative humidity in %.

According to the value provided by the DI index, climatic conditions might be defined comfortable, uncomfortable or unbearable:

	Comfortable	Slightly Uncomfortable	Uncomfortable	Highly Uncomfortable	Unbearable
68	70	75	80	86	

### ***Net Index NI***

It is defined as follows:

$$NI = 37 - \frac{37 - T}{0.68 - 0.0014 \cdot H + \frac{1}{1.76 + 1.4 \cdot v^{0.75}}} - 0.29 \cdot \left(1 - \frac{H}{100}\right) \cdot T$$

where T = temperature in °C,  
H = relative humidity in % and  
v = air velocity in m/s.

NI provides the so called “apparent temperature”: in fine climatic conditions, the Net Index approaches the T temperature expressed in °C (Celsius) degrees. As climatic conditions get worst, humidity weight and air velocity become always more evident and the Net Index provides an apparent temperature that reflects the human typical feelings and deviates significantly from the temperature value:

- In a hot climate, NI increases as temperature and/or humidity increases, but it decreases as wind increases.
- In a cool climate, NI decreases as temperature decreases and as humidity and wind increase.

## PP471 ELECTRONIC MODULE FOR PRESSURE MEASUREMENT

The electronic module PP471 connect the instrument with the TP704 and TP705 series Delta Ohm pressure probes. When switching on the instrument allows automatically the acknowledgement of the module PP471 while the kind (absolute, relative or differential) and the full scale value of the probe are acknowledged even if the instrument is switched on: if no logging or recording is running, it's not necessary to switch off and then on the DO9847 to change the probe connected to the module.

The module supplies two values identified with the number 1 ad 2:

1 (A1, B1 or C1) the instantaneous value of pressure and

2 (A2, B2 or C2) the peak value identified with a lowercase “p” letter near the measuring unit.

The <9/UNIT> key changes the measuring unit of the instantaneous and peak values. The following units of measurement are available: Pa, hPa, kPa, mbar, atm, mmHg, mmH<sub>2</sub>O, kgf/cm<sup>2</sup>, PSI, inchHg.

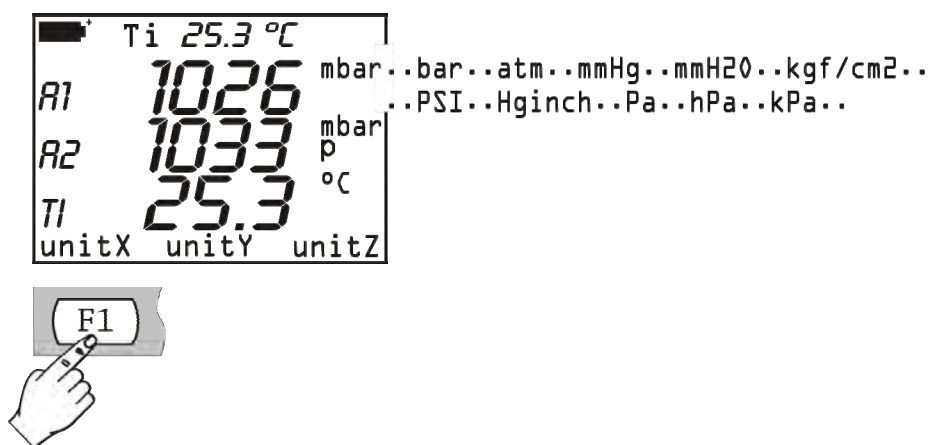

Some units of measurement require the use of a multiplicative factor: when the symbol ‘+3’ appears on the top it means that the value displayed has to be multiplied by 1000.

### Reset Command

To reset the peak value, press the ESC/CLR key. The message resetA, resetB or resetC appears on the controls bar according to which input the module is connected to. When the correspondent F1, F2 or F3 function key is pressed, the peak value become the same as the instantaneous value.

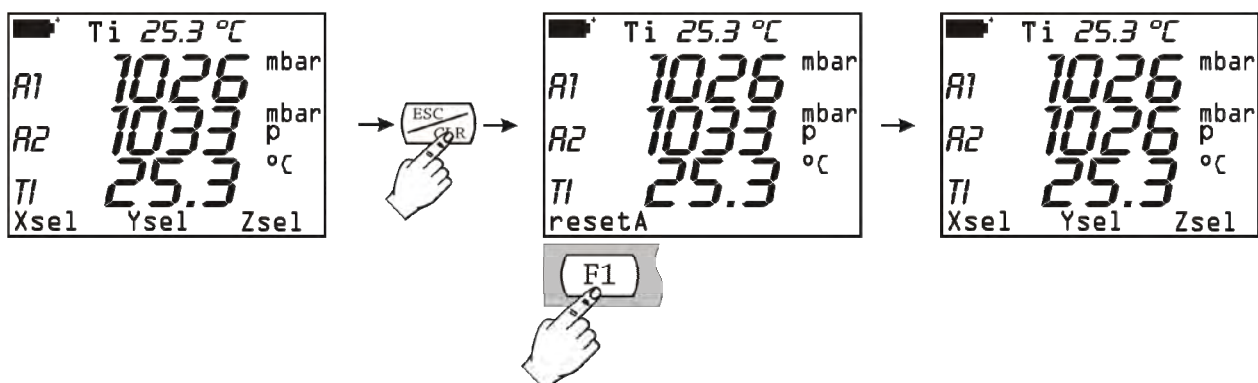

During the logging function, when the sampling interval is lower than 60 seconds, the peak value is cleared: thus, the value being acquired is the highest peak since acquisition was started. On the contrary, in case of intervals corresponding to or higher than 60 seconds, the peak is cleared after

each acquisition: thus, the peak value being stored is the one related to the single interval between two subsequent acquisitions. Here are the reasons why two different operating modes have been chosen: when the sampling interval is short, all of the pressure measurements together reflect quite faithfully the progress of pressure over the time. In case of long intervals, the pressure value of each interval and of the absolute peak does not provide any accurate information: knowing each peak value between two subsequent samplings provides an additional information about pressure changes over the time.

### Zero Command

There could be a little difference between the two inputs of the differential probes and then the instrument doesn't display the value of zero even though the pressure measured for both the probe inputs is exactly the same. For this purpose there is a reset command of the differential value: let the inputs of the probe open so that they can measure the same pressure and then press the <0> reset key.

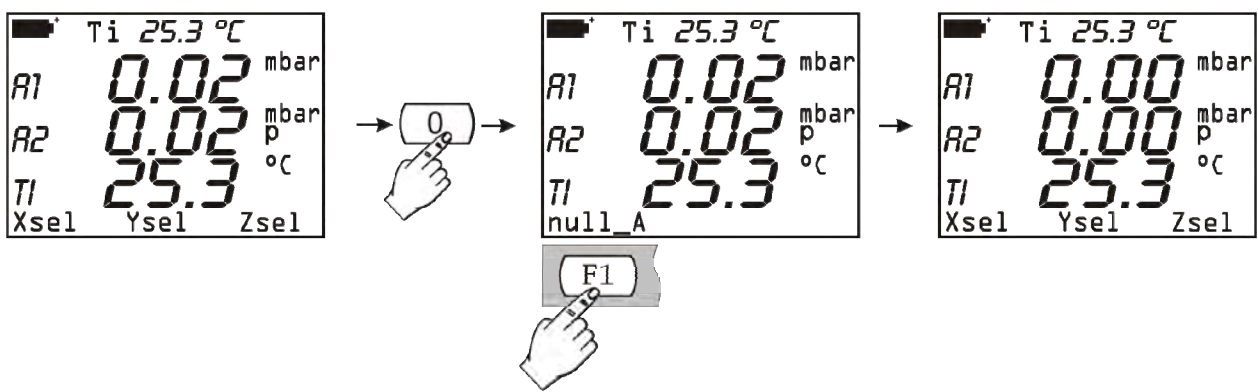

The message null\_A, null\_B or null\_C appears in the controls bar according to which input the module is connected to. Press the function key corresponding to the input to reset the differential pressure: the instantaneous value and the corresponding peak value are set to zero.

### Relative measure

The function “relative measure” can be applied, selectively for every input channel, to all pressure probes TP704 and TP705 connected through the interface module PP471. With respect to the analogue function with the <8/REL> key, this function can be applied separately to each input channel.

In order to enable it, press the key<+/-> in the command bar. The symbol “Ref” appears, followed by the letter that identifies the input channel. By pressing the corresponding function key (F1, F2 or F3), the instrument displays the difference between the current value and the value when the key has been pressed.

The activation of the function is marked by a small “r” letter beside the letter A, B or C which identify the input channel. To disable the function, press the function key again.

## PP472 ELECTRONIC MODULE FOR BAROMETRIC PRESSURE MEASUREMENT

The electronic module PP472 measures the barometric pressure connected to its input in the range 600.0...1100.0 hPa. The resolution is equal to 0.1 hPa for the whole measuring range.

The <9/UNIT> key selects the unit of measurement of the displayed instantaneous value. The following units are available:

hPa, kPa, mbar, bar, atm, mmHg, mmH<sub>2</sub>O, kgf/cm<sup>2</sup>, PSI, inchHg.

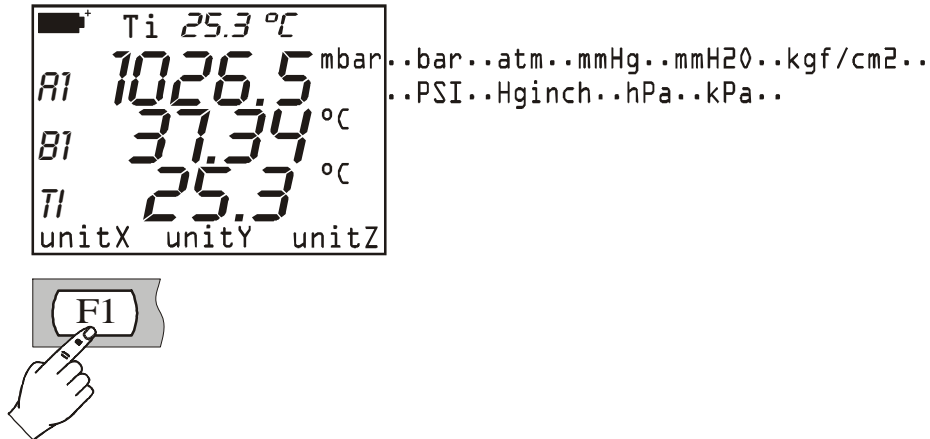

### Calibration

The module PP472 can be recalibrated by the user who has a precision pressure generator. The calibration is carried out in two points: the first at 800.0mbar, the second at 1013.0mbar.

Procedure:

1. Connect the module PP472 to one of the input of DO9847 and switch on the instrument.
2. Enter into the Menu with the proper key and select the heading '5) Calibrate' with the <5/DATACALL> key. The list of the modules connected to the instrument is displayed: select the input which the module PP472 is connected to.
3. The first screen appears as follows:

```
Set 800.0 mbar
↓) Keep & Proceed
<ENTER> = update
<ESC> = abandon
Up/Down vary setpoint
800.0 mbar
```

Supply the module input with a pressure of 800.0mbar. The bottom line displays the value measured by the instrument. The set point value can be adjusted with the arrows (*Up and Down*) up to the pressure value which is really measured. Update the value with <ENTER> key and continue with the second point pressing the <1/MATH> key.

4. The second calibration point is 1013.0mbar. If necessary, adjust the set point value with the arrows (*Up and Down*) up to the pressure value which is really supplied. Update the value with the <ENTER> key and confirm with the <1/MATH> key. Now calibration is finished.

## PP473 ELECTRONIC MODULE FOR THE MEASUREMENT OF DIFFERENTIAL PRESSURE

PP473 S1, S2, ..., S8 electronic modules measure differential pressures with 10, 20, 50, 100, 200, 500, 1000 and 2000 mbar full scale.

These modules provide the pressure instantaneous value related to variable 1 (A1, B1 or C1 depending on the input to which the module is connected).

The <9/UNIT> key switches the unit of measurement of the instantaneous value. The available units of measurement are:

Pa, hPa, kPa, mbar, bar, atm, mmHg, mmH<sub>2</sub>O, kgf/cm<sup>2</sup>, PSI, inchHg.

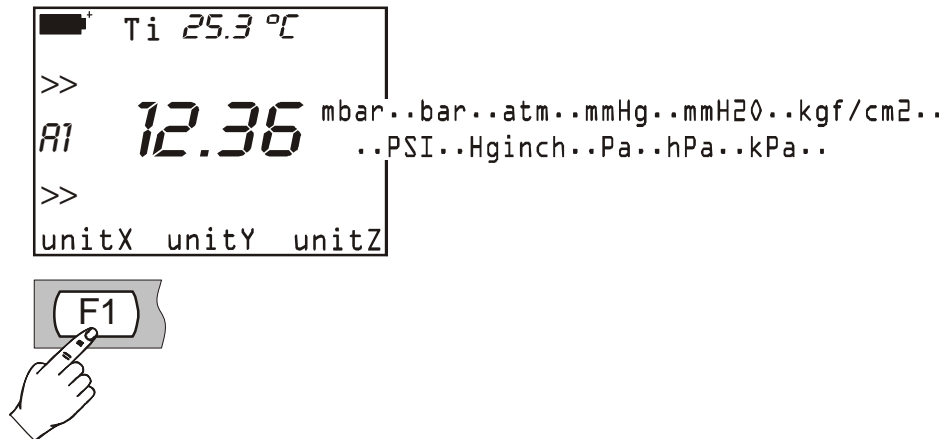

Some units of measurement require a multiplicative factor: “+3” at the top means that the displayed value has to be multiplied by 1000.

### Zero Command

Differential probes might cause a slight difference between the two inputs, so that the instrument will not show the value zero, even if the pressure applied to the two inputs is the same. To this purpose, the instrument provides a reset command of the differential value: leave the probe inputs open to let them measure the same pressure, then press <0> to reset.

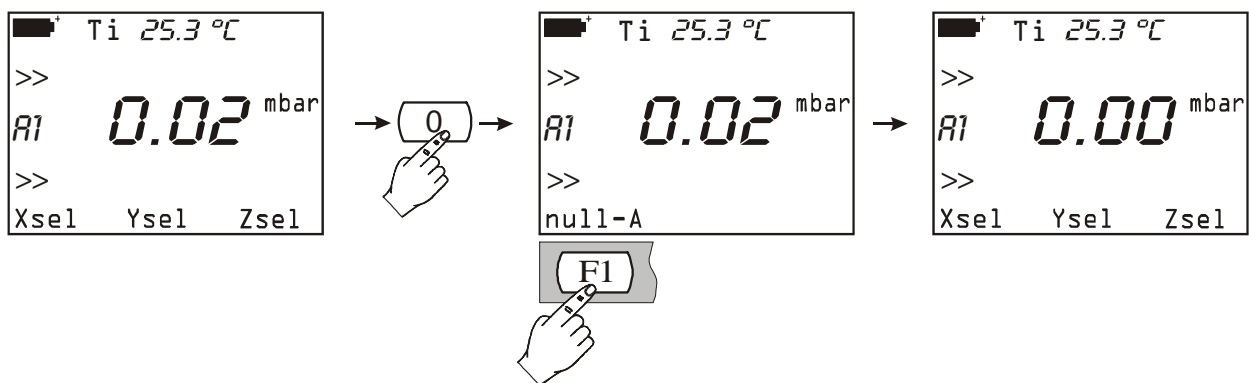

The commands bar will show either null\_A, null\_B or null\_C, according to the input to which the module is connected. Press the corresponding function key to reset differential pressure: the instant value will be set at zero.

## AP471..., AP472... AND AP473...

### PROBES FOR THE MEASUREMENT OF AIR VELOCITY EQUIPPED WITH SICRAM MODULE

The probes of AP471, AP472 and AP473 series are to be connected to a DO9847 multifunction instrument to measure velocity and flow of an incident airstream. Some of these probes can also measure air temperature. Applied principles of measurement are three: hot-wire for the AP471 series, vane for the AP472 series and Pitot tube for the AP473 series. On request the probes of AP471 and AP472 series can be equipped with a telescopic shaft to make measurements in hard-to-access areas (such as in vents, or in duct inlets/outlets) easier.

Their main applications include: the control of air velocity and flow on conditioning, heating and cooling plants, the definition of ambient comfort, etc.

Hot-wire probes are generally used for accurate measurements in environments with a medium-low air velocity (up to 10 m/s), vane probes in environments with air velocity from 5 to 50m/s, Pitot tube probes in environments with air velocity higher than 40m/s.

The temperature of the fluid to be measured has to be also taken into consideration: hot-wire probes measure streams having an 80°C max. temperature, vanes reach 120°C, while Pitot tube probes measure the velocity of air streams having temperature up to 600°C, according to the model.

Measurements provided by these probes are:

- air velocity (variable identified by number 1, that is A1, B1 or C1),
- air temperature (variable identified by number 2, that is A2, B2 or C2),
- flow (variable identified by number 3, that is A3, B3 or C3).

**The probes of AP471, AP472 and AP473 series provide three different measures at the same time (air velocity, air temperature and flow). To view the three measurements contemporaneously, no other probe has to be connected to the instrument.**

Insert the connector with the SICRAM module in one of the inputs (i.e. “A”) and then turn the instrument on. Should the display indicate that an input variation has occurred, wait for a few seconds. The instrument will turn off and then on again, displaying the 3 measurements: A1 (velocity), A2 (temperature) and A3 (flow). If the probe is not equipped for measuring temperature, only A1 (velocity) and A3 (flow) variables will be viewed.

Press <9/UNIT> to select the units of measurement of the displayed instantaneous value. The following units are available:

- m/s, km/h, ft/min, mph, knots for air velocity;
- °C, °F and °K for air temperature;
- l/s, m<sup>3</sup>/s, m<sup>3</sup>/min, ft<sup>3</sup>/s, ft<sup>3</sup>/min for flow.

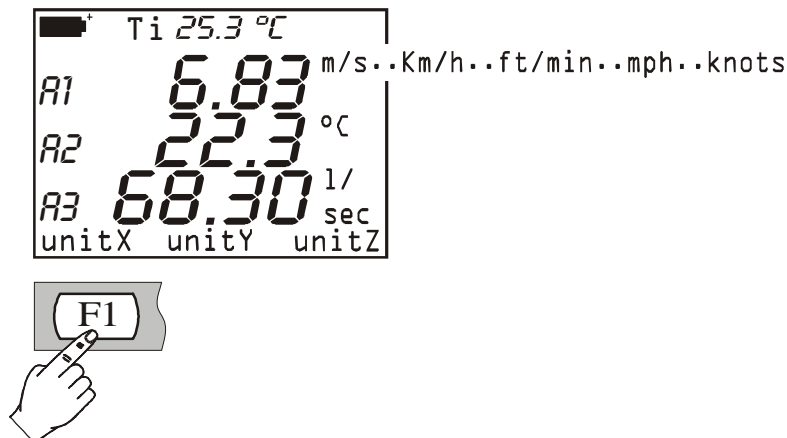

## Note Concerning DO9847 Version

AP471, AP472 and AP473 probes can work connected to a DO9847 only if this is provided with the 2.0 firmware version, or with a later one. Previous versions do not support these probes. To check which is your firmware version, open the menu and select INFO: VER 2 REV 0 indication corresponds to version 2.0.

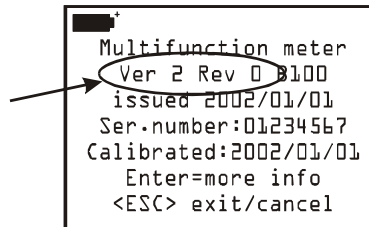

Firmware versions prior to 2.0 can be factory upgraded.

## Flow Measurement

The measurement of air flow requires to know the area of the pipe or of the vent perpendicular to the flow: to set this parameter, DO9847 units are provided with a specific function. Open DO9847 menu (2.0 version, or superior), select “7) Utility” and then “1) Area calculations”. See page 24 for a detailed description of this function.

Note: **when measuring flow, use only one anemometric probe at any one time** because the function allows to configure one only area. On the contrary, several anemometric probes, as well as other kinds of probes, can be used contemporaneously when measuring air velocity.

## Operating

If you move the probe inside a stream, velocity and flow can change both their position throughout the space (from a point to another) and their performance over the time (in the same position, but in subsequent moments): this is particularly true when the involved area is quite big and when some turbulences are generated in front of a ventilating grill or of a diffuser. The DO9847 unit provides some solutions to get a correct measurement even before these elements of disturbance.

### 1) Space Average (Record Function)

It is always suggested to record more measurements in different positions and to consider as valid data only average values. By means of the *Record* function, the DO9847 can acquire several measurements and provide, at the end, maximum, minimum and average values.

Press <6/RCD> to activate the Record function. Use the <F3> function key to reset any prior measurement, then place the probe in the first point to be measured and press F2 (function key) M(n=00) to acquire the first value. Repeat these steps for each other point to be measured and press <F2> each time: the M(n=...) indicator, in the middle of the commands bar, will indicate the number of acquired samples. After acquiring, press <5/DataCall>: press either F1, F2 or F3 to read the min, max, and average value of the three quantities: velocity, temperature and flow.

In general, the bigger the number of acquired measurements is, the higher the accuracy of the results will be.



## 2) Moving Average

The Record function provides a space average of acquired values in order to compensate velocity differences between a point and another in the pipe section. There is also another cause of error due to stream variations over the time: actually, a stream is not steady but, on the contrary, it can decrease or increase even in the same point. In order to compensate this second source of instability, a time moving average of the last **n** acquired measurements can be provided: thus  $n > 1$  will not correspond to a single acquired value, but to the current average of the last recorded and continuously updated **n** measurements.

To set the “**n**” value, select “8) Options” in the menu, then choose “2) Flow averaging time” parameter: the “**n**” value can be selected from 1 (no average) to 100.

For a detailed description of this function, see page 26, “Flow averaging time” paragraph.

Note: grills and diffusers with reclining fins cause stream measurement errors because of turbulences. These turbulences develop because part of the stream meets an obstacle (the fin) and, consequently, slows down, while the rest of the stream speeds ahead. In this case, to get correct measurements, it is suggested to temporarily insert, in front of the ventilating grill, a pipe, having a length twice the length of the grill diagonal. Measurements have to be taken at the ends of this pipe. The area to be considered for flow calculations will be that of the temporary pipe positioned between the ventilating grill and the probe.

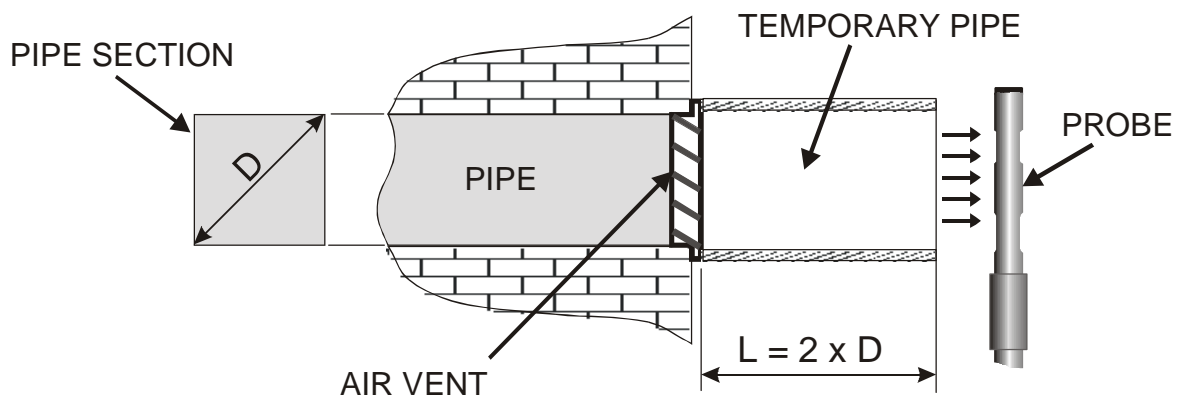

<i>Unit Conversion Table</i>					
	<b>m/s</b>	<b>ft/min</b>	<b>km/h</b>	<b>mph</b>	<b>knots</b>
<b>1 m/s</b>	1	196.87	3.60	2.24	1.944
<b>1 ft/min (1 foot/minute)</b>	0.00508	1	0.01829	0.01138	$9.874 \cdot 10^{-3}$
<b>1 km/h</b>	0.2778	54.69	1	0.6222	0.5399
<b>1 mph (1 statute mile /hour)</b>	0.4464	87.89	1.6071	1	0.8689
<b>1 knot</b>	0.5144	101.27	1.852	1.151	1

**AP471 S1, AP471 S2, AP471 S3 , AP471 S4, AP471S5 AND AP471S6  
HOT WIRE PROBES FOR MEASUREMENT OF AIR VELOCITY EQUIPPED WITH SICRAM MODULE**

The AP471 S1 and AP471 S3 probes measure incident air flows up to 40m/s. The AP471 S2, AP471 S4, AP471 S5 and AP471 S6 probes are fitted with an omnidirectional sensor allowing measurement of speeds up to 5m/s in any direction of the air flow incident on the probe. The AP471 S4 probe is fitted with support base and sensor protection, the AP471 S5 is identical to the AP471 S4, but instead of a base it is provided with a telescopic rod. The wind speed measurement is compensated for according to temperature within the range of 0...+80°C. The probes AP471S1, AP471 S2, and AP471S3 measure the environment temperature in the range of -30°C...+110°C; AP471 S4, AP471S5 and AP471 S6 probes in the range 0°C...+80°C.

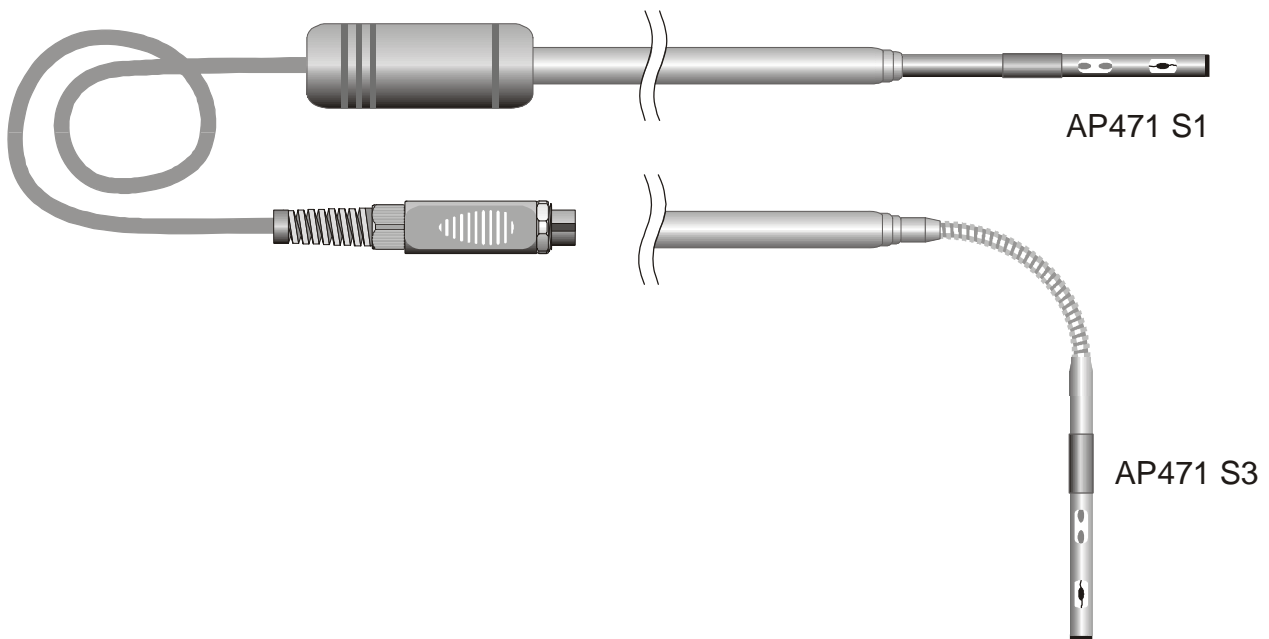

**Zero Command**

The AP471S... modules are factory calibrated and do not require any calibration by the user. Before carrying out a measurement, you have to adjust the “zero” point of the probe. This means that, failing the wind, velocity and flow values provided by the probe, at a temperature next to that of the airstream to be measured, shall correspond to zero.

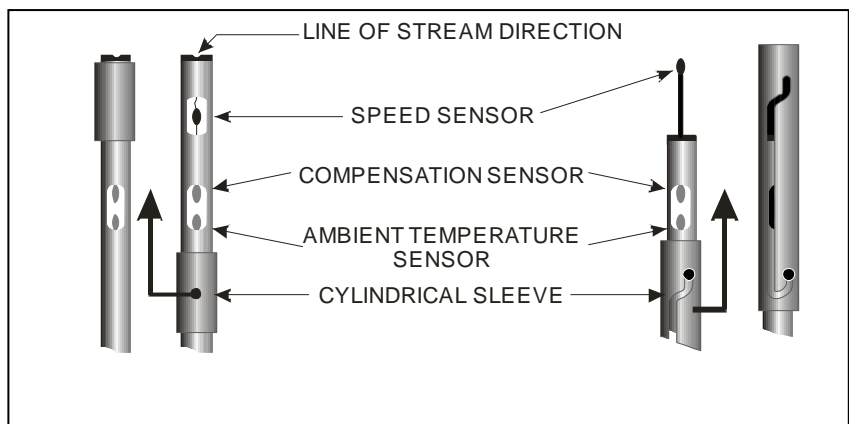

The AP471 S1, S2 and S3 probes are fitted with a cylindrical protection screen that can slide longitudinally over a groove. The screen has two end-of-travel positions that block it in measurement condition (completely low) or rest condition (completely high). To reduce the space occupied when

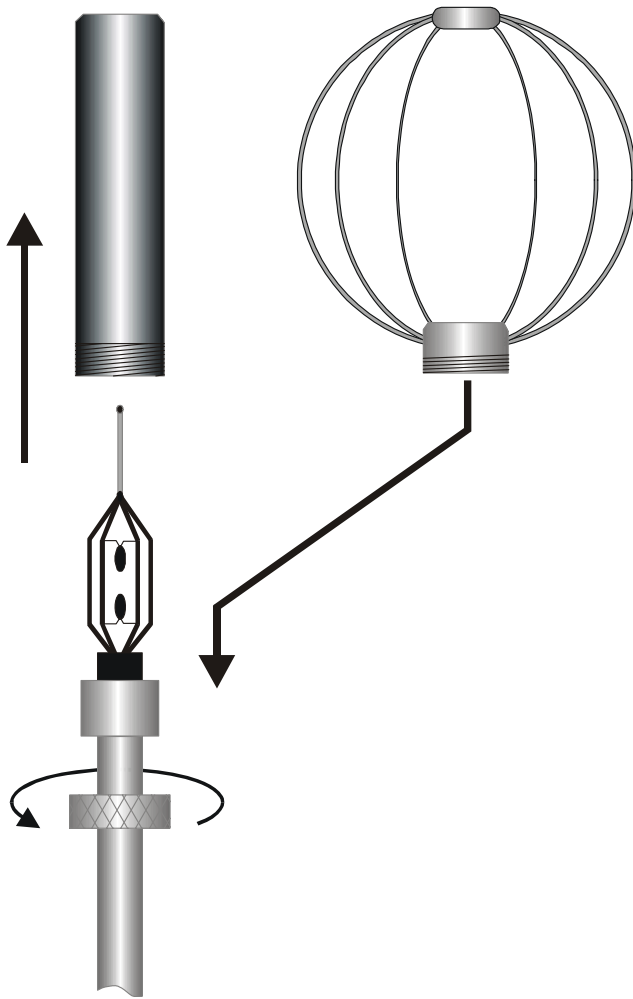

not used, the AP471 S4, AP471 S5 and AP471 S6 are supplied with a protection inder that can be screwed on the probe's head. The procedure is the following: slide the cylindrical shield up till the complete closing of the air sensor window placed on the top of the probe. By the AP471 S4, S5 and S6 probes the protection cylinder closes the probe top. Place the head of the probe in the airstream to be measured and press the reset key (<0>). The notice "null\_A, null\_B o null\_C" will appear on the commands bar, according to the input to which the module is connected. Press the corresponding function key to reset measurement: any fault (drifts) related to velocity and flow instantaneous values will be cleared.

### Operation

To reduce battery consumption, upon the instrument power on, air velocity and flow indications are in a stand-by condition and the message "*Probe STD\_BY!* <ENTER> to toggle" will be viewed: the velocity sensor will not be powered until the <ENTER> key is pressed. Even during standard working, if you press <ENTER> alternatively, the current

measurement will be stopped and restarted.

Extend the telescopic shaft as much as necessary, taking care that the cable passes through the handle without any problem.

Cover the velocity sensor and reset the measurement value, as detailed in the previous paragraph. Uncover the sensor and position the probe in the airstream to be measured holding the arrow on the top of the probe parallel to flow, as indicated in the following pictures.

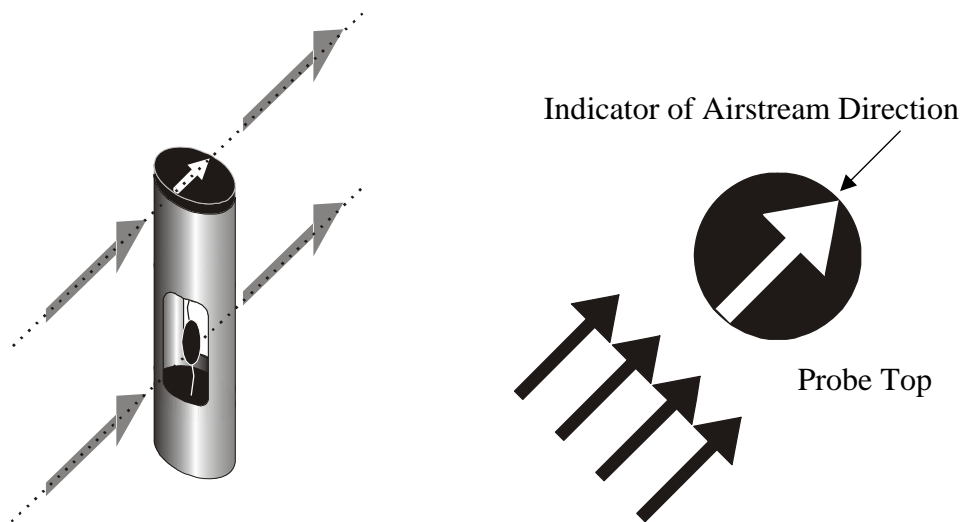

The probe has to stand in orthogonal position with respect to the flow and it shall not to be inclined:

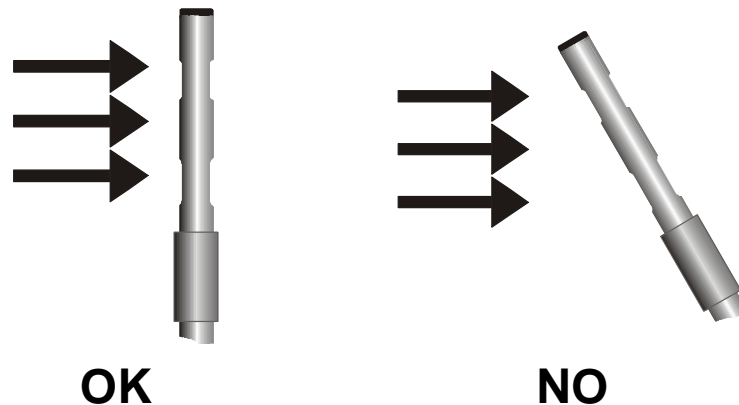

Now you can carry out your measurement, pursuant to the indications provided in the first paragraphs of this chapter.

### Probe Care and Maintenance



The velocity sensor of AP471 S... probes is heated up and, **in presence of vapour or gas, it might cause a fire or an explosion. Avoid using these probes if inflammable gases are available. Check that no gas leak or explosive product vapour be present in the environment where measurements have to be carried out.**

The probe is very delicate and has to be handled with care. Even in case of light impact, the probe can be damaged, most of all for omnidirectional probes which sensor is uncovered. At the end of measurement, the sensor placed on the top of probe has to be protected by the metal sleeve or by a threaded cylinder which the probe is equipped with. During the use, the omnidirectional probes AP471 S4 and AP471 S5 have to be protected by the relevant metal frame supplied together with the instrument. During the transport, the sensor has to be closed in the relevant protection cylinder by screwing it on the end of the probe.

Do not touch sensors with your fingers.

Use pure alcohol to clean sensors.

## Dimensions

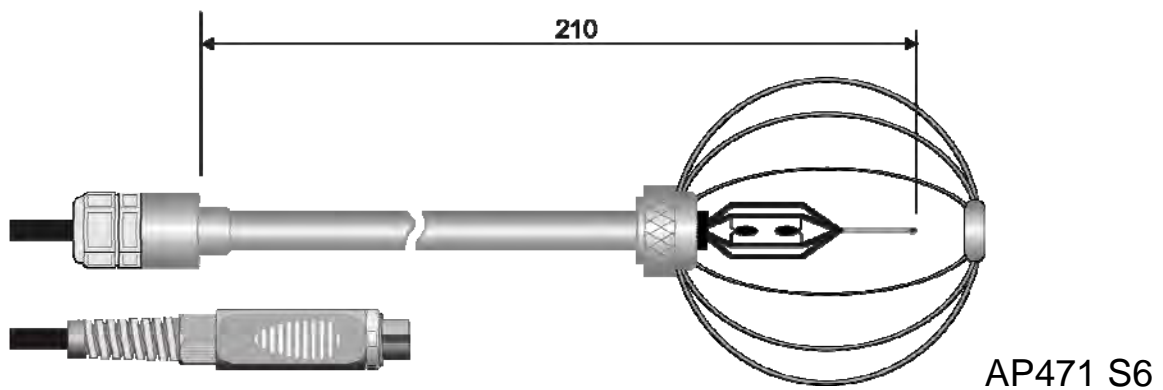
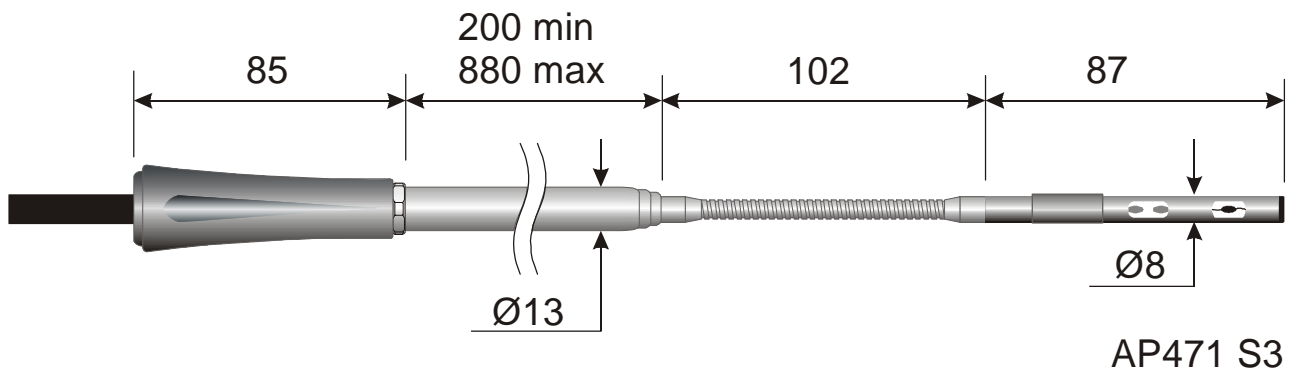
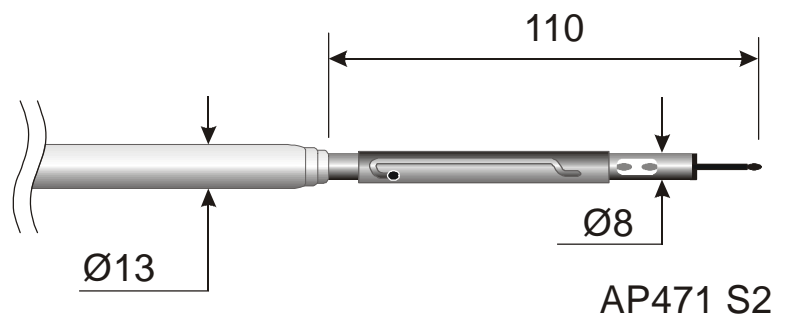
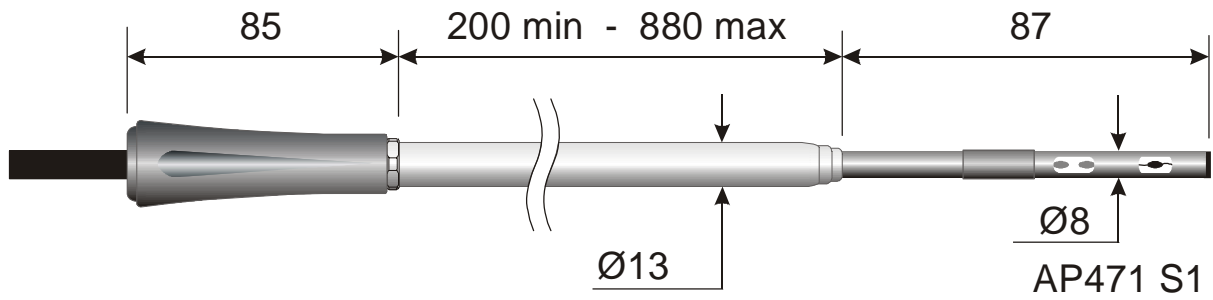

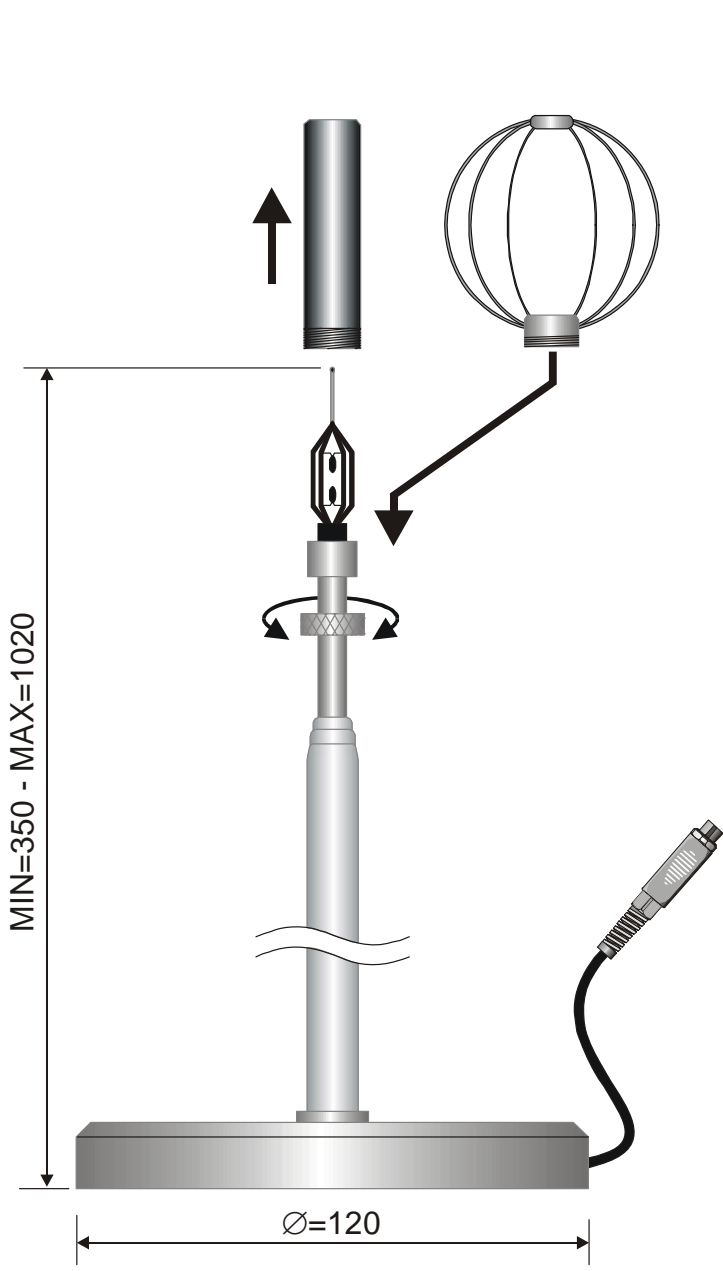

**AP471 S4**

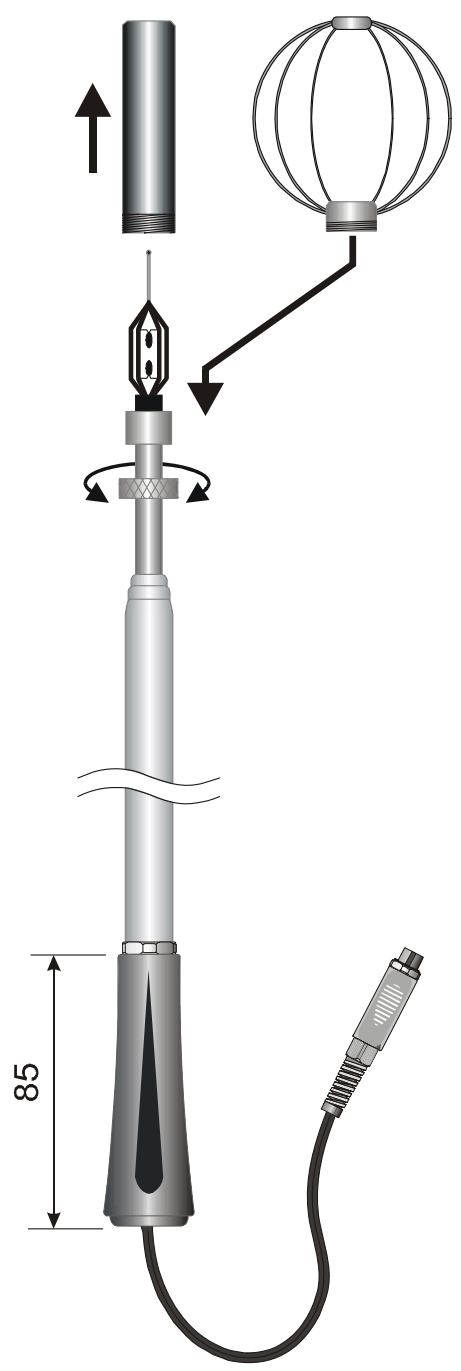

**AP471 S5**

## Technical Specifications

	AP471 S1 - AP471 S3	AP471 S2	AP471 S4 AP471 S5 AP471 S6
<i>Type of Measurements</i>	Air Velocity, Calculated Flow, Air Temperature		
<i>Type of Sensor</i>			
Velocity	NTC thermistor	Omni-directional NTC thermistor	
Temperature	NTC thermistor	NTC thermistor	
<i>Measurement Range</i>			
Velocity	0.05...40m/s	0.05...5m/s	
Temperature	-30...+110°C	-30...+110°C	0...80°C
<i>Measurement Resolution</i>			
Velocity	0.01 m/s (0.05...40 m/s) 0.1 km/h 1 ft/min 0.1 mph 0.1 knots	0.01 m/s (0.05...5 m/s) 0.1 km/h 1 ft/min 0.1 mph 0.1 knots	
Temperature	0.1°C (-30...+110°C)	0.1°C (-30...+110°C)	
<i>Measurement Accuracy</i>			
Velocity	±0.05 m/s (0.05...0.99 m/s) ±0.2 m/s (1.00...9.99 m/s) ±0.6 m/s (10.00...40.00 m/s)	±0.02m/s (0.05...0.99 m/s) ±0.1m/s (1.00...5.00 m/s)	
Temperature	±0.4°C (-30...+110°C)	±0.4°C	±0.4°C
<i>Min. Velocity</i>	0.05 m/s		
<i>Air Temperature Compensation</i>	0...80°C		
<i>Battery Life</i>	Approx. 20 ore @ 20 m/s with alkaline batteries	Approx. 30 ore @ 5 m/s with alkaline batteries	
<i>Unit of Measurement</i>			
Velocity	m/s – km/h – ft/min – mph – knots		
Flow	l/s – m <sup>3</sup> /s – m <sup>3</sup> /min – ft <sup>3</sup> /s – ft <sup>3</sup> /min		
<i>Pipe Section for Flow Calculation</i>	100...100000 cm <sup>2</sup> 0.01...10 m <sup>2</sup>		
<i>Calculation of Pipe Section (for Flow Measurement)</i>	The section area can be assigned: <ul style="list-style-type: none"> <li>• directly (cm<sup>2</sup> or inch<sup>2</sup>)</li> <li>• by setting the radius (cm or inch) of circular sections</li> <li>• by setting the sides (cm or inch) of rectangular sections</li> </ul>		
<i>DO9847 Firmware Upgrade</i>	2.0 and following ones		
<i>Cable Length</i>	~2m		

**AP472 S1, AP472 S2 AND AP472 S4**  
**VANE PROBES FOR AIR VELOCITY MEASUREMENT EQUIPPED WITH SICRAM MODULE**

AP472 S1, S2 and S4 vane probes are to be connected to DO9847 multifunction instrument. They are used to measure velocity and flow of an incident air flow. AP472 S1, AP472 S4LT and AP472 S4HT probes can measure temperature also by means of a thermocouple type K. On request they are equipped with a telescopic shaft to make measurements easier in hard-to-reach areas (i.e.: duct outlets and vents). The table below shows velocity and temperature ranges of these probes:

	<b>Speed (m/s)</b>	<b>Temperature (°C)</b>	<b>Temperature sensor</b>	<b>Diameter (mm)</b>
<b>AP472 S1</b>	0.6...30	-25...+80	Thermocouple K	100
<b>AP472 S2</b>	0.3...20	-25...+80 (working temperature)	----	60
<b>AP472 S4L</b>	0.8...20	-25...+80 (working temperature)	----	16
<b>AP472 S4LT (on request)</b>	0.8...20	-30...+120 (*)	Thermocouple K	16
<b>AP472 S4H</b>	10...50	-25...+80 (working temperature)	----	16
<b>AP472 S4HT (on request)</b>	10...50	-30...+120 (*)	Thermocouple K	16

(\*) Temperature limit refers to the probe where the vane and temperature sensor are located and not to the handle, the cable and telescopic shaft which maximum working temperature is 80°C.

Bigger diameters are suitable for measurements in turbulent flows having a low-medium air velocity (i.e. in front of pipes). Smaller diameters are suitable for applications where the body of the probe has to be much smaller than the cross section of the duct where measurements have to be carried out (i.e.: air ducts).

### Calibrations

AP472 S1, S2 and S4 probes are factory calibrated and do not require any calibration by users.

### Operation

Slide the telescopic shaft as much as necessary and take care that the cable can pass through the tube without any problem.

Position the probe in the air flow to be measured and hold the vane axis parallel to the stream, as indicated in the following figure.



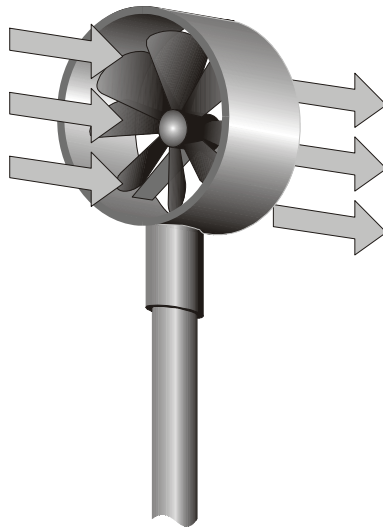

The probe has to stand orthogonal with respect to the flow and it shall not to be inclined:

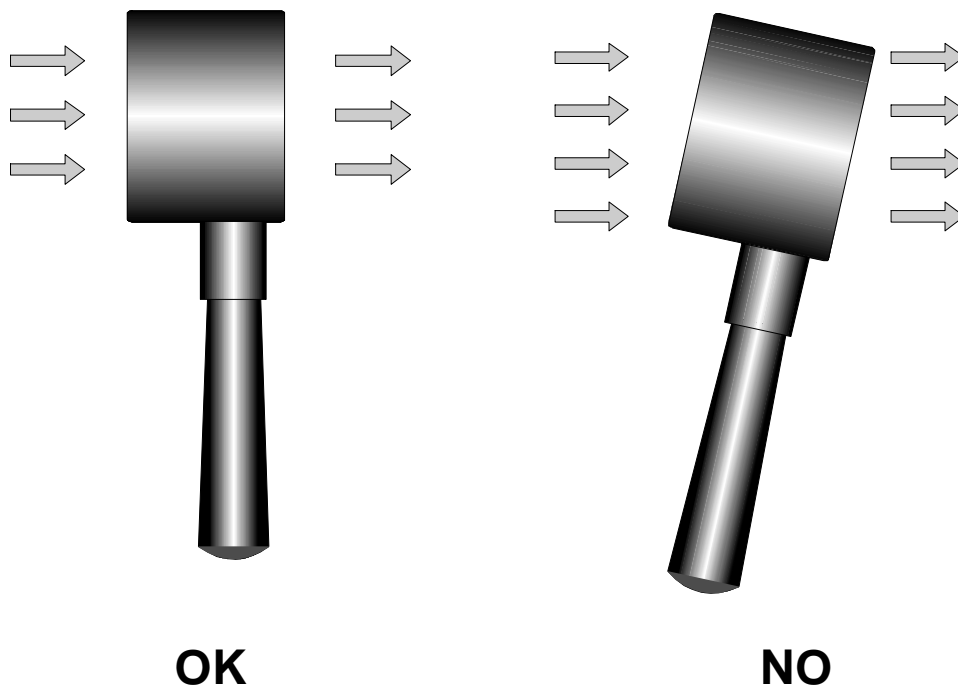

The probe is correctly positioned in the air stream when the measured value is the highest one. Carry out measurements pursuant to the indications provided in the first paragraphs of this chapter.

### Probe Care and Maintenance

Probe performances, particularly at lowest speeds, depend on the friction with which the vane turns around its own pivot. Low friction levels assure better performances. To guarantee this feature, it is suggested neither to force, lock or rotate the vane with fingers, nor to position it, as much as possible, in airstreams containing elements that might cause the probe to get dirty.

## Dimensions

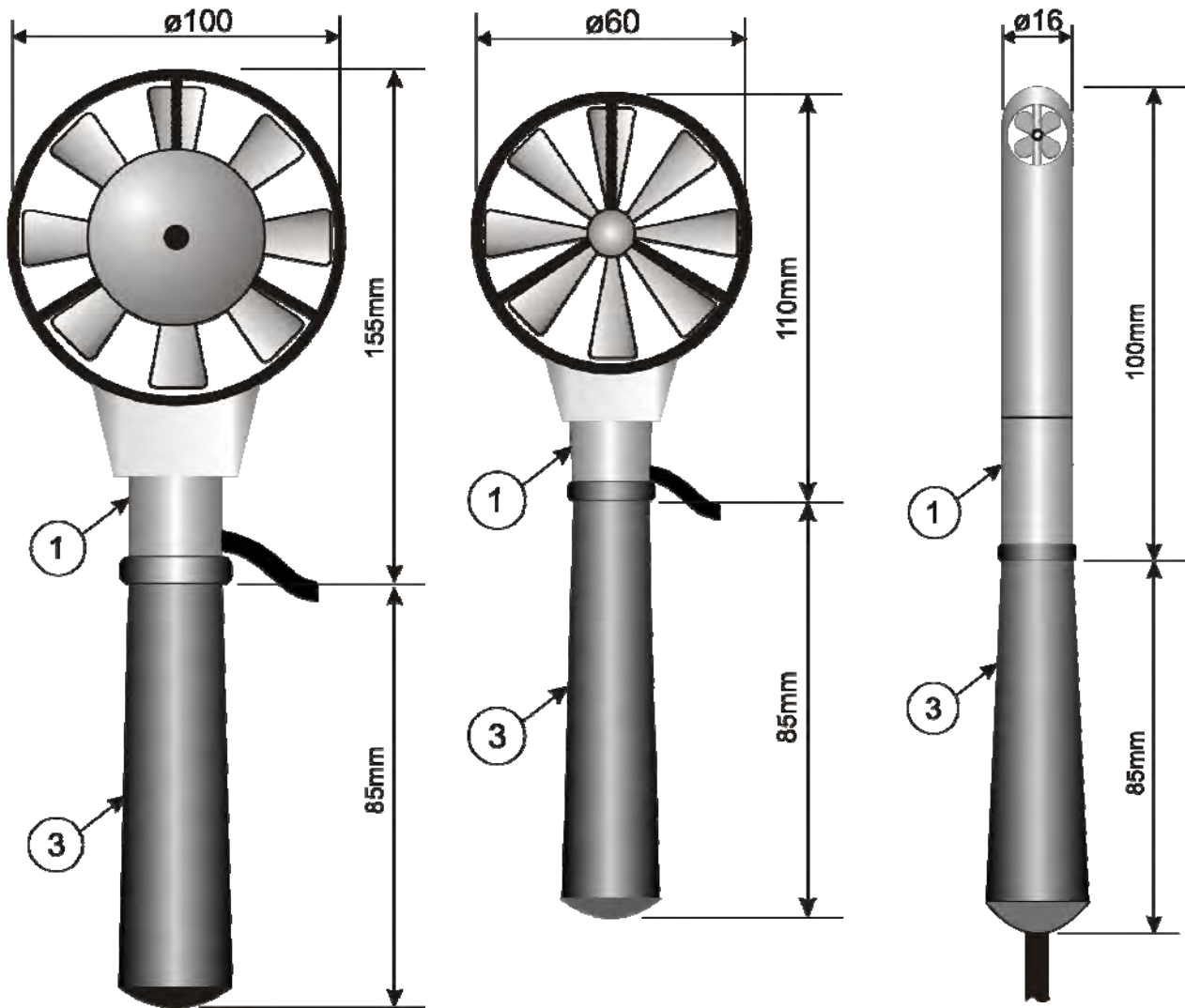

**AP472 S1**

**AP472 S2**

**AP472 S4**

Unscrew the handle (3) holding the probe body still in the point (1).

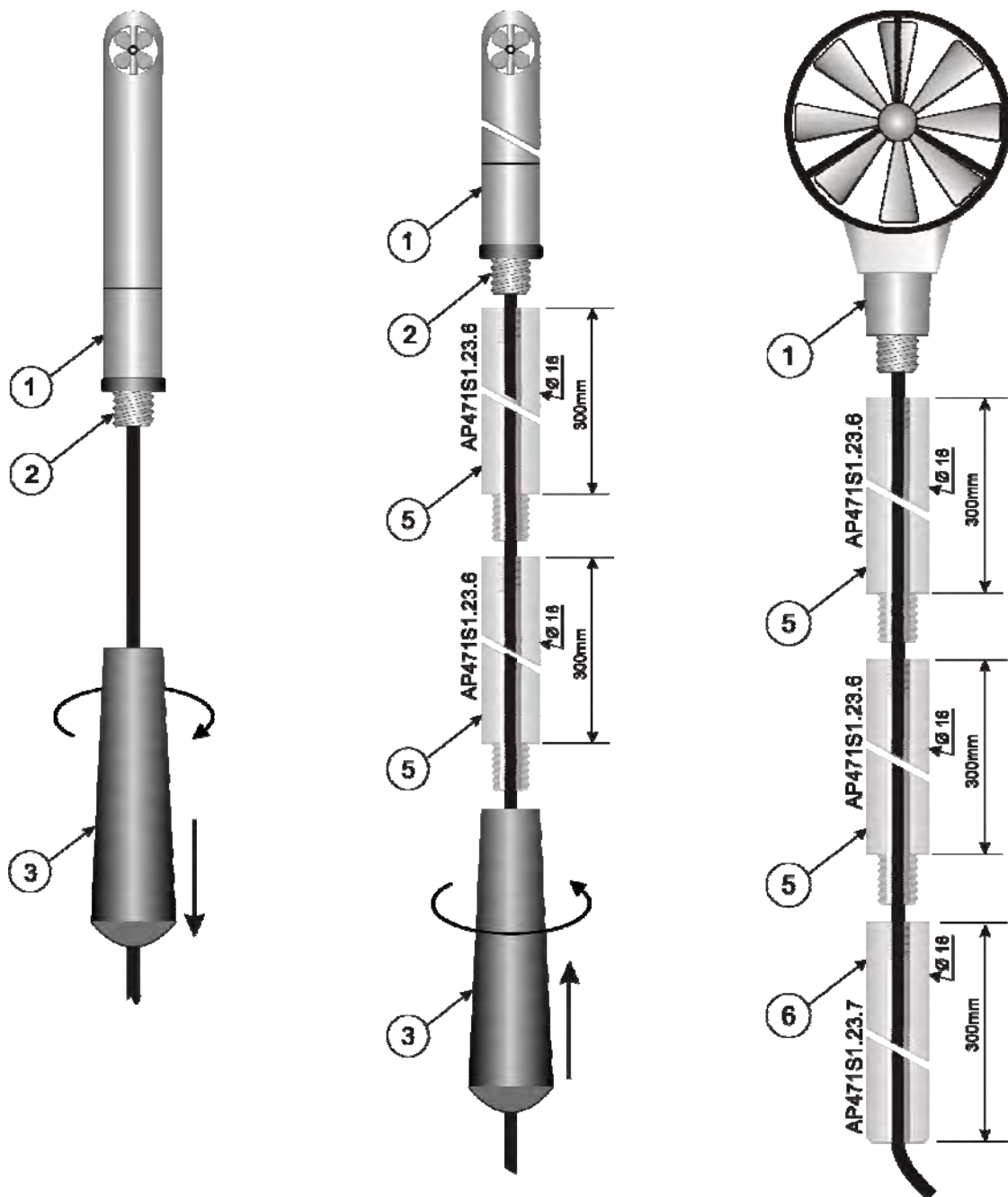

The **AP472 S1 - AP472 S2** probes, in addition to the telescopic rod with swivel head can use the rigid telescopic rod  $\varnothing 16$  mm. Unscrew the handle (3) holding the probe body still in the point (1). Screw the rod end **AP471S1.23.6** (5) on the screw (2). You can add more telescopic rods **AP471S1.23.6**. The last element can be the handle (3) or the telescopic rod **AP471S1.23.7** (6).

The **AP472 S4** probe can be used with the rigid telescopic rods **AP471S1.23.6**.

## Technical Specifications

	AP472 S1	AP472 S2	AP472 S4...			
			L	LT	H	HT
<i>Type of Measurements</i>	Air velocity, calculated flow, air temperature	Air velocity, calculated flow	Air velocity, calculated flow	Air velocity, calculated flow, air temperature	Air velocity, calculated flow	Air velocity, calculated flow, air temperature
<i>Diameter</i>	100 mm	60 mm	16 mm			
<i>Type of Measurement</i>			Vane			
Velocity	Vane	Vane	----	Tc K	----	Tc K
Temperature	Tc K	----	----	----	----	----
<i>Measuring Range</i>			0.8...20		10...50	
Velocity (m/s)	0.6...30	0.3...20				
Temperature	-25...+80	-25...+80 (*)	25...+80 (*)	30...+120 (**)	25...+80 (*)	25...+80
<i>Resolution</i>	0.01 m/s - 0.1 km/h - 1 ft/min - 0.1 mph - 0.1 knots					
Velocity						
Temperature	0.1°C	----	----	0.1°C	----	0.1°C
<i>Accuracy</i>			±(0.2 m/s +1.0%f.s.)			
Velocity	±(0.1 m/s +1.5%f.s.)	±(0.1m/s +1.5%f.s.)				
Temperature	±0.1°C	----	----	±0.1°C	----	±0.1°C
<i>Min. Velocity</i>	0.6m/s	0.3m/s	0.8m/s		10m/s	
<i>Unit of Measurement</i>	m/s – km/h – ft/min – mph - knots					
Velocity						
Flow	l/s – m <sup>3</sup> /s – m <sup>3</sup> /min – ft <sup>3</sup> /s – ft <sup>3</sup> /min					
<i>Duct Section for Flow Calculation</i>	100...100000 cm <sup>2</sup> 0.01...10 m <sup>2</sup>					
<i>Calculation of Duct Section (for Flow Measurement)</i>	<p>The area of the section can be assigned:</p> <ul style="list-style-type: none"> <li>• directly (cm<sup>2</sup> or inch<sup>2</sup>)</li> <li>• by setting the radius (cm or inch) for circular sections</li> <li>• by setting the side length (cm or inch) for rectangular sections</li> </ul>					
<i>DO9847 Firmware Upgrade</i>	Version 2.0 and following ones					
<i>Cable Length</i>	~2m					

(\*) The indicated value refers to the vane operating range.

(\*\*) Temperature limit refers to the probe where the vane and temperature sensor are located and not to the handle, the cable and telescopic shaft which maximum working temperature is 80°C.

AP473 S1 ... AP473 S4

PITOT TUBE PROBES FOR THE MEASUREMENT OF AIR VELOCITY EQUIPPED WITH SICRAM  
MODULE

The Pitot tube is an easy method to measure air velocity in hard-to-reach positions, such as air ducts, and in applications where air velocity and temperature are very high. As no air passes through it, the Pitot tube is particularly suitable for measurements in hostile environments.

**Measuring Principle**

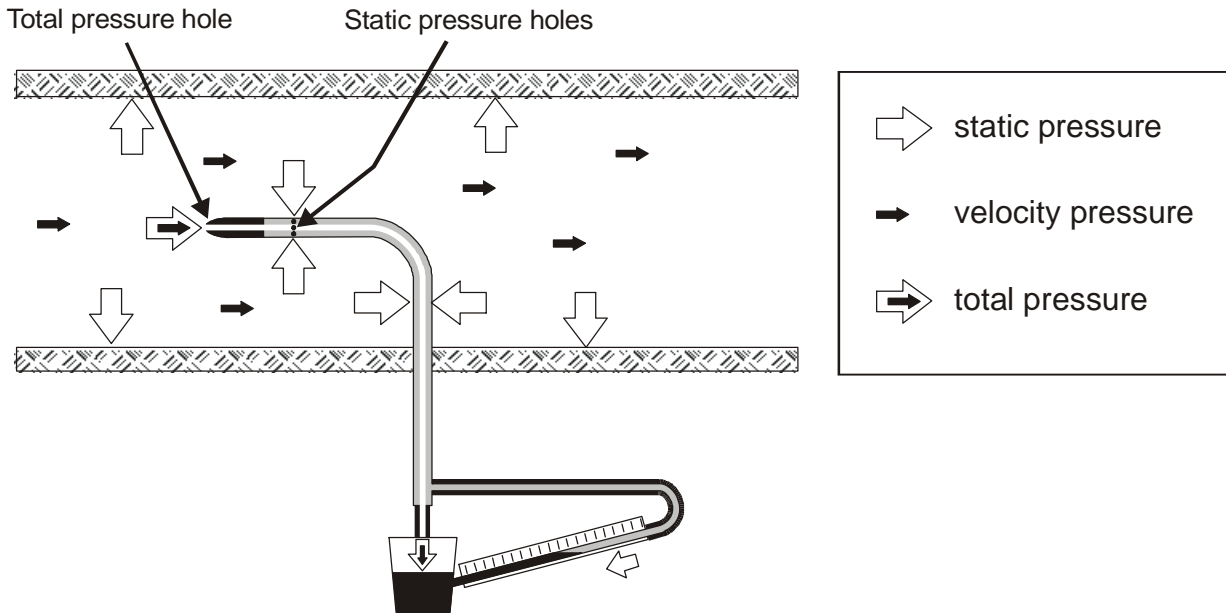

The pressure inside the duct is the result of three different pressures:

- 1) atmospheric pressure (barometric B)
- 2) static pressure  $P_s$
- 3) dynamic pressure  $P_v$  due to the non-null velocity of the air inside the duct.

The following formula provides the air velocity: as you can see, it depends on the three pressures and on air temperature.

$$(1) \quad v = 1.291 \cdot \sqrt{\left[ \frac{1000}{B} \cdot \frac{T}{289} \cdot \frac{100.000}{100.000 + P_s} \cdot P_v \right]}$$

$[v] = \text{m/s}$   
 $[B] = \text{mbar}$   
 $[P_v] = [P_s] = \text{Pa}$   
 $[T] = \text{°K}$

The Pitot tube provides the difference between the pressure available on the front mouth and the one measured through the lateral holes, that is  $P_v$  dynamic pressure:

$$(P_s + P_v) - P_s = P_v$$

If  $P_s$  is lower than 2500 Pa (=25mbar), the term  $\frac{100.000}{100.000 + P_s}$  can be disregarded as the error is of approx. 1%.

## AP473 S1 ... AP473 S4 modules

AP473 S1, ..., AP473 S4 modules work as interfaces between the Pitot tube and the DO9847 unit. Each module can be connected to any Pitot tube with the related thermocouple type K, where provided. With temperature and atmospheric pressure standard conditions, S1 has a 40m/s full scale, S2 a 55m/s full scale, S3 a 90m/s full scale and S4 a 130m/s full scale.

The modules of AP473 series are equipped with two pressure inputs to be connected to the Pitot tube tube outputs and with an input for thermocouples type K.

The measurements provided by the modules are:

- air velocity and differential pressure  $P_v$  (A1, B1 o C1)
- air temperature measured by a thermocouple (A2, B2 or C2)
- flow (A3, B3 or C3)

Press <9/UNIT> to select the units of measurement of the displayed instant value:

- for air velocity: m/s, km/h, ft/min, mph, knots
- for differential pressure (one unit of measurement only): Pa
- for temperature: °C, °F o °K
- for flow: l/s, m<sup>3</sup>/s, m<sup>3</sup>/min, ft<sup>3</sup>/s, ft<sup>3</sup>/min.

## Operation

Insert SICRAM module connector in one of the instrument inputs (i.e.: A); connect Pitot tube outputs (pressure and thermocouple) to the module.

Introduce the Pitot tube in the airstream to be measured, positioning the little rod at the bottom of the tube parallel to the flow, as indicated in the following figure.

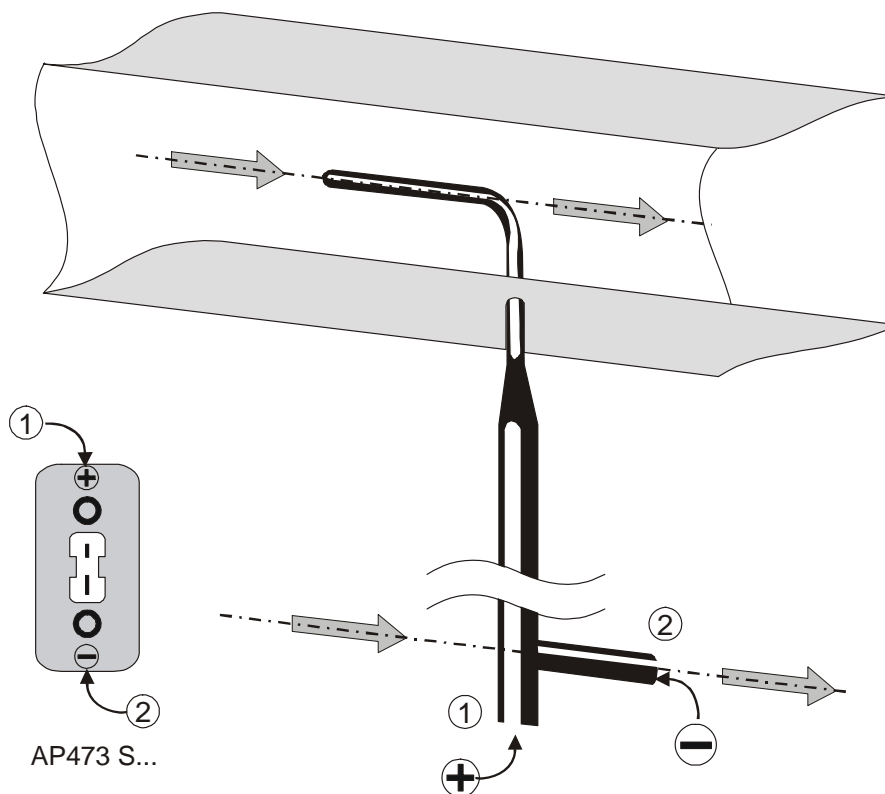

The graph below shows the error in case of misalignment:

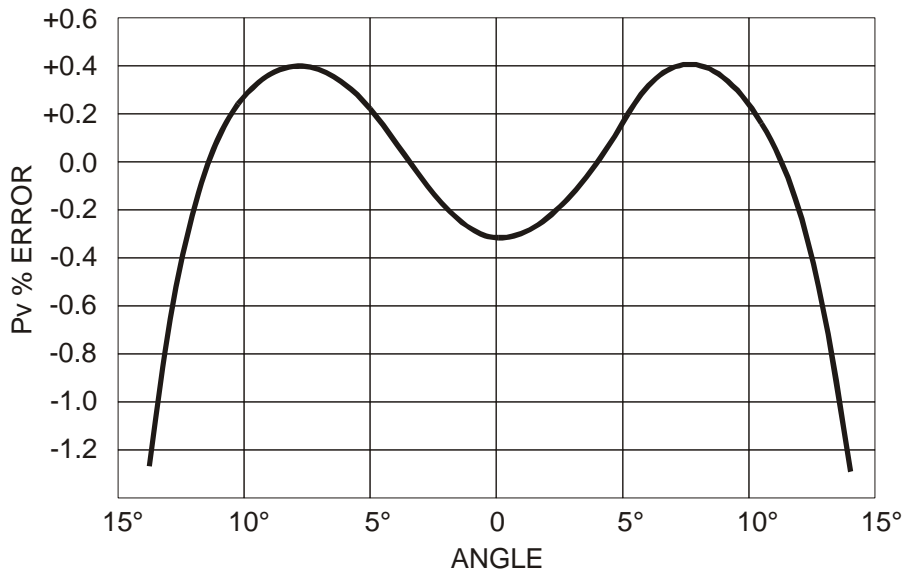

The axis of abscissas shows the rotation angle around the vertical axis with respect to the flow direction (yawing), the ordinate axis shows the % error on Pv differential pressure measurement. As you can see, a difference of more than 10° implies an error in the differential pressure measurement lower than 0.5%.

The function that provides the velocity rate – report (1) on page 61 – is affected by temperature and by atmospheric pressure, as well. Temperature is measured by a thermocouple connected to the module, when available. As alternative, another source can be selected, choosing “8-1) Comp.Temp select” in the menu (see page 26).

The same procedure applies to atmospheric pressure: a module that measures atmospheric pressure (PP472) connected to one of the inputs, can be selected as parameter for velocity calculation. Otherwise, you can digit directly the pressure value in mbar (see “8-3) Comp Atm. Pressure” description in the menu on page 27).

### Dimensions of Pitot Tubes

	T1-...	T2-...	T3-...	T4-...	
Diameter d (mm)	3	5	8	10	
Point Length t (mm)	33	55	88	135	
Length L (mm)	300	400 600	500 800	500 800 1000	
Ordering Code (*)	T1-300	T2-400 T2-600	T3-500 T3-800 T3-800TC	T4-500 T4-800 T4-800TC T4-1000 T4-1000TC	

(\*) TC = Pitot tubes with ‘K’ thermocouple sensor

## Technical Specifications

	AP473 S1	AP473 S2	AP473 S3	AP473 S4
<i>Type of Measurements</i>	Air velocity, calculated pressure, differential pressure, air temperature			
<i>Measurement Ranges</i>				
Differential Pressure	10 mbar	20mbar	50mbar	100mbar
Velocity (*)	2 ... 40m/s	2 ... 55m/s	2 ... 90m/s	2 ... 130m/s
Temperature	-200...+600°C	-200...+600°C	-200...+600°C	-200...+600°C
<i>Resolution</i>	0.1 m/s - 1 km/h - 1 ft/min - 1 mph - 1 knots			
Velocity	0.1°C			
Temperature				
<i>Accuracy</i>	±0.4%f.s. of pressure		±0.25%f.s. of pressure	
Velocity	±0.1°C		±0.1°C	
Temperature				
<i>Min. Velocity</i>	2 m/s			
<i>Compensation of Air Temperature</i>	-200...+600°C (if thermocouple type K is connected to the module)			
<i>Units of Measurement</i>				
Velocity	m/s – km/h – ft/min – mph - knots			
Flow	l/s – m <sup>3</sup> /s – m <sup>3</sup> /min – ft <sup>3</sup> /s – ft <sup>3</sup> /min			
<i>Section of the Pipe for Flow Calculation</i>	100...100000 cm <sup>2</sup> 0.01...10 m <sup>2</sup>			
<i>Calculation of the Pipe Section (for Flow Measurement)</i>	The area of the section can be assigned: <ul style="list-style-type: none"> <li>• directly (cm<sup>2</sup> or inch<sup>2</sup>)</li> <li>• setting the radius (cm or inch) of circular section</li> <li>• setting both sides (cm or inch) of rectangular sections</li> </ul>			
<i>DO9847 Firmware Upgrade</i>	Version 2.0 and following ones			

(\*) At 20°C, 1013mbar and Ps negligible.



## VP472 ELECTRONIC MODULE FOR SOLARIMETERS AND ALBEDOMETERS

The VP472 electronic module allows you to connect solarimeters and albedometers to the DO9847. The signal generated by the thermopile and detected by the VP472 module may be expressed either as a voltage in mV or as global radiation in  $W/m^2$ . When the module is inserted in input A, B or C of the DO9847, the variable identified with the number 1 (A1, B1 or C1) supplies:

1. the output voltage of the thermopile which detects the incident light (in mV) in the solarimeter,
2. the incident global radiation (in  $W/m^2$ ) in the solarimeter with ring,
3. the net radiation defined as the difference between the incident global radiation and the reflected global radiation (in  $W/m^2$ ) in the albedometer.

The variable identified with the number 2 (A2, B2 or C2) supplies:

4. the output voltage of the thermopile which detects the reflected light (in mV) in the albedometer,
5. the albedo defined as the ratio between the reflected global radiation and incident global radiation.

If a solarimeter is connected to the module, only the variables n points 1 and 2 must be considered. To show on the display one of the three variables identified with the numbers 1, 2 or 3 of the points in the list, proceed as follows: with the commands *Xsel-Ysel-Zsel* select the variable A1, B1 or C1 (depending on whether the module is connected to input A, B or C) then, with the key <9/UNIT>, select the desired variable from the three available. In the same way, to view one of the variables corresponding to points 4 or 5, select the variable A2 (or B2 or C2) then, with the key <9/UNIT>, select one of the two variables available: point 4 or 5 (*See the description of the commands Xsel-Ysel-Zsel on p.14 and the UNIT function on p.10*).

The correspondence between the output signal in voltage and the global radiation in  $W/m^2$  is obtained by means of the solarimeter parameter called sensitivity S (or calibration factor). This constant, supplied with the solarimeter, must be inserted by means of a special item on the menu.

### Inserting the sensitivity of the solarimeter or albedometer

The default value of the sensitivity parameter is  $10000nV/(Wm^{-2})$ . To modify it, insert the module in the DO9847 and switch on the instrument. Go to the MENU with the respective key (if the indication "WARNING! CHANGE OF PROBE DETECTED..." appears, press any key).

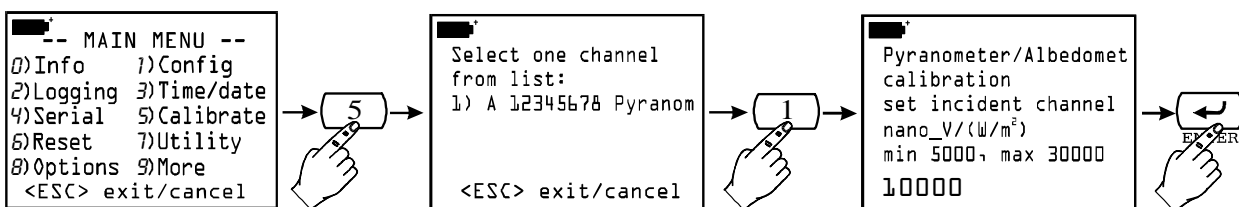

Press the key <5> to enter the calibration submenu. With the keys <1>, <2> or <3> select the module of the solarimeter from the list proposed by the instrument (in the example only one module for solarimeters is connected): a screen appears which asks you to insert the sensitivity of the thermopile which detects the **incident** radiation in  $nanoV/(Wm^{-2})$ <sup>(3)</sup>. Type in the value, which must be between 5000 and 30000 $nV/(Wm^{-2})$ , and press <ENTER> to confirm it. In this way a second screen appears, referring to the sensitivity of the thermopile which detects the **reflected** radiation.

<sup>(3)</sup>  $1\mu V$  is equal to 1000nV

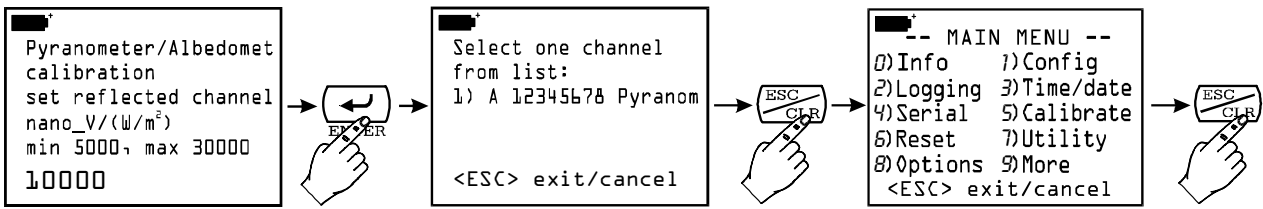

Insert the second parameter or leave the default value of 10000 if the second input of the module is not being used; press <ENTER> to confirm and <ESC/CLR> twice to return to normal measurement. At this point the instrument supplies the indications of the solarimeter outputs in voltage (in mV) or in global radiation (in W/m<sup>2</sup>).

### Electrical connection of the solarimeter or of the albedometer to the VP472 module

The VP472 module is provided with a 6-pole terminal board with screw connectors. Connect the solarimeter or the albedometer respecting the correct polarity of the signals: the figures below show the connections for the solarimeter Delta Ohm LP PYRA 02 and the two albedometers LP PYRA 06 and LP PYRA 05. In the case of a single output (solarimeter LP PYRA 02 or LP PYRA 03) connect only input 1 of the module (incident radiation) and make a jumper between the inputs 2. Connect the shield of the cables to the terminal indicated with SHIELD.

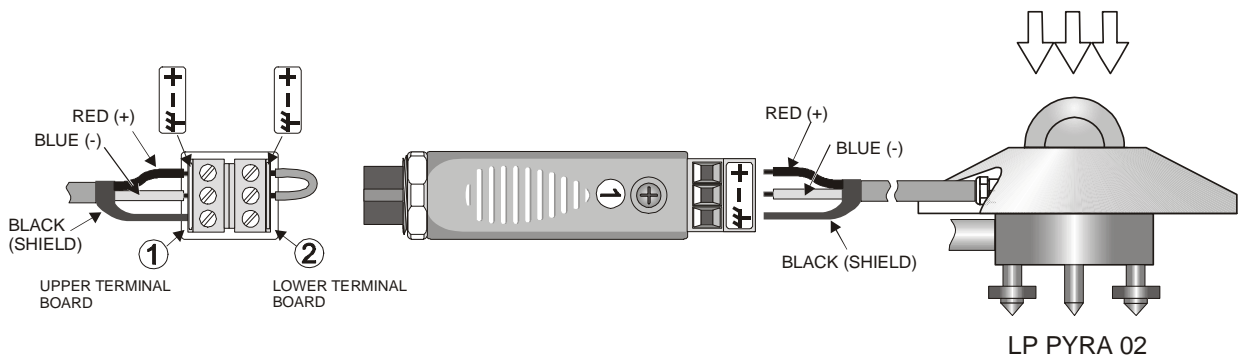

### Electrical connection of the VP472 module to the solarimeters LP PYRA 02 and LP PYRA 03

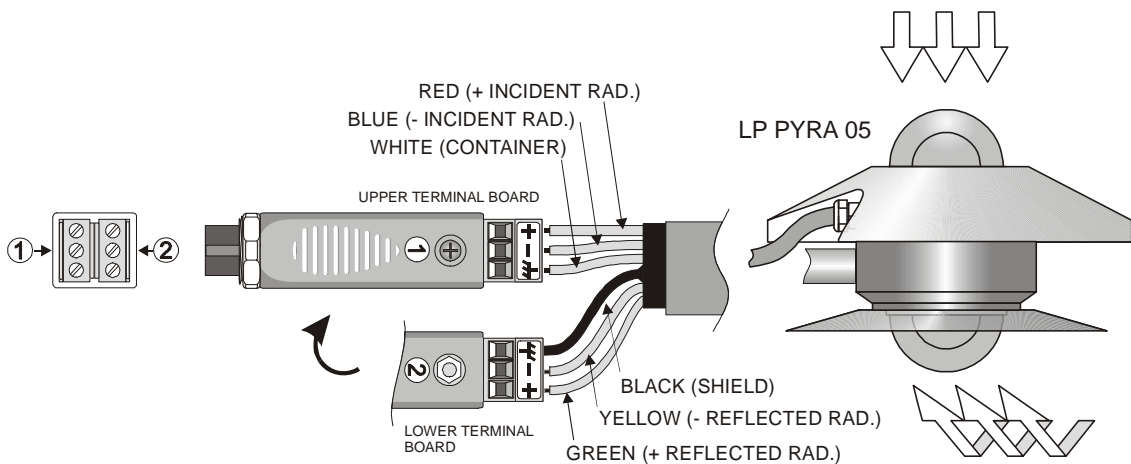

### Electrical connection of the VP472 module to the albedometer LP PYRA 05

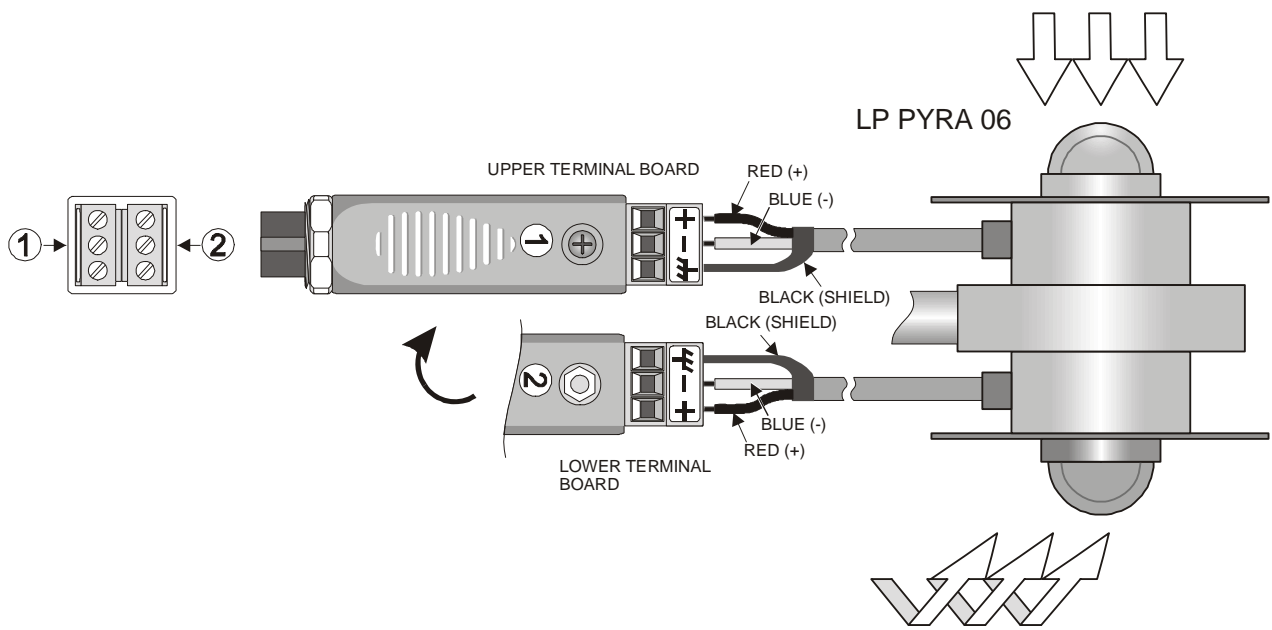

Electrical connection of the VP472 module to the albedometer LP PYRA 06

## LP 471 PHOT, RAD, UVA, UVB, UVC, PAR AND LUM2 PHOTOMETRIC AND RADIOMETRIC PROBES EQUIPPED WITH SICRAM MODULE

Probes of LP471... series are photometric and radiometric probes measuring **illuminance** (LP471 PHOT), **irradiance** (LP471 RAD, LP471 UVA, LP471 UVB and LP471 UVC), **PAR** (LP471 PAR) and **luminance** (LP471 LUM 2). All of them, but LUM 2, are provided with a diffuser for cosine correction.

Upon power on, the instrument automatically detects the probes connected to its inputs: you just have to connect the probe module and, if the instrument is already on, switch it off and on again to allow the instrument to identify the module. The unit of measurement is defined by the instrument according to the module connected to its inputs: when a probe can provide different units of measurements, press the <9/UNIT> key to select the one you need.

All probes are factory calibrated and do not need any additional calibration by the user.

In addition to instant measurement, our multifunction instrument can also calculate the integral over the time of acquired measurements and can contemporaneously show, on the display three lines, instant measurements, integrated measurements and time in seconds. A number of limits settable from menu can be combined either with an integrated measurement or with the integration time and, when exceeded, the instrument stops the integral calculation.

Measurements provided by the probes are:

- Instant measurement (variable identified by number 1, that is A1, B1 or C1),
- Integration time in seconds (variable identified by number 2, that is A2, B2 or C2),
- Q Integral (variable identified by number 3, that is A3, B3 or C3).

If two probes of the same type are connected to the instrument, among the variables selectable by means of Xsel, Ysel and Zsel keys, the difference between instant values (A1, B1 e C1) will also be available.

**Note: for LP471 LUM 2 luminance probe, the calculation of integral is not provided.**

The following table lists the available units of measurements, according to the type of probe connected to the instrument.

Type of Measurement	Unit of Measur.	Q Integral Unit of Measurement
Illuminance (Phot)	lux fcd	lux·s fcd·s
Irradiance (RAD - UVA - UVB - UVC)	W/m <sup>2</sup> μW/cm <sup>2</sup>	W·s/m <sup>2</sup> μW·s/cm <sup>2</sup>
PAR	μmol/(m <sup>2</sup> ·s)	μmol/m <sup>2</sup>
Luminance (LUM 2)	cd/m <sup>2</sup>	----

## Q/TIME INTEGRATION

Besides instant measurements, our multifunction instrument can calculate the following summation, as well:

$$(1) \quad Q(t) = \sum_0^t u(t) \cdot \Delta t, \quad \Delta t = 1 \text{ sec}$$

where  $u(t)$  is the instant value of the input variable at time  $t$ . Sampling interval is fixed and equals 1 second.

As soon as the  $Q(t)$  value or  $t$  integration time reach set limits, integration will stop and “*Q/T Time limit*” message will be displayed.

Integration Max. Time	100 hours, 00 minutes, 00 seconds
Integration Interval	1 second
Number of Measuring Ranges	5 auto-selected ranges

## Setting Limits

Insert the module of your probe into one of the inputs (i.e.: “A”) and then turn on the instrument. If a message appears signalling that an input change has been detected, wait for a few seconds. The instrument will turn off and on immediately after displaying 3 measurements: A1 (light instant measurement), A2 (integration time) and A3 (Q integral). If more probes are connected, display indication will be different, but, using Xsel, Ysel and Zsel function keys, you can anyhow change the data provided by the instrument.

In order to set integration limits, choose “8) Option” from the menu and select “4) Q/T mode parameters” submenu.

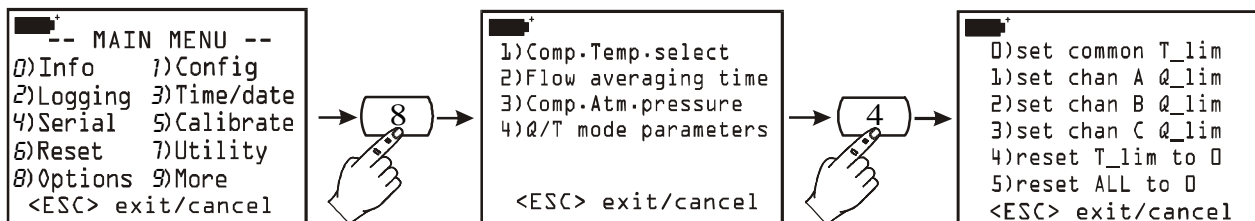

Now you can:

- Set, by means of <0> key, **the integration limit time that will be the same for all of the probes connected to the instrument;**
- Set, by means of <1>, <2> and <3> keys, **the integration limit value of one of the probes connected to the instrument inputs;**
- Clear the limit time previously set by means of the <4> key;
- Clear any previous setting by means of the <5> key.

The asterisk symbol (\*) appears aside a set item.

## How to Enter the Integration Final Time

Starting from the last screen-page shown on page 2, press <0>. Enter the limit time in hours, minutes and seconds using the arrows to move from a character to the other. Press <ENTER> to confirm.

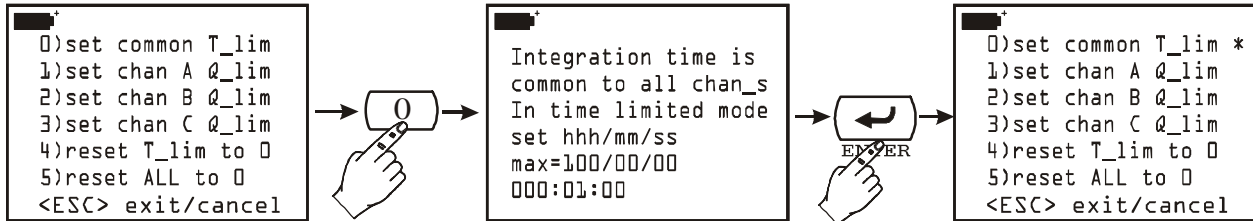

## How to Enter the Integration Final Value

Starting from the main screen-page, press either <1>, <2> or <3> to set the Q(t) limit related to the probe connected either to A, B or C input, respectively. **Items are not displayed if no probe is connected to the relating input.**

Enter the limit value using the arrows to move from a character to the other. Press <ENTER> to confirm.

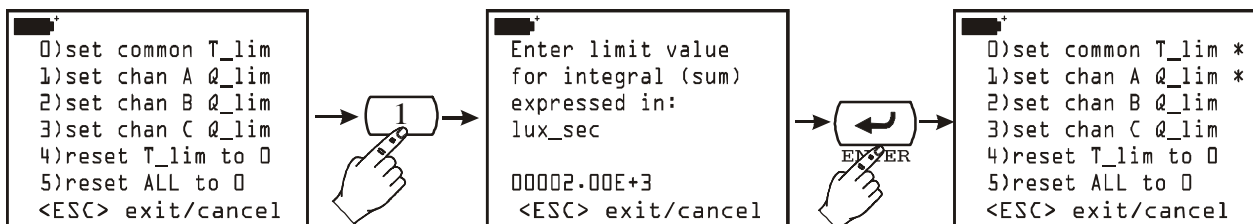

To clear the value of a limit time previously set, press <4> to activate the "4) reset T\_lim to 0" command; press <5> to activate the "5) reset ALL to 0" command and reset everything.

## How to Make an Integration Measurement

After setting limits, as indicated above, quit the menu and go back to standard measuring. Press <1/MATH>: aside F1 and F3 function keys Q/Tgo and Q/Tclr indications will appear. The first one starts integration calculation, while the second one clears the values of a previous integration and brings it to zero: if an integration is started and the <Q/Tclr> key is not pressed, the calculation will start from the previous values.

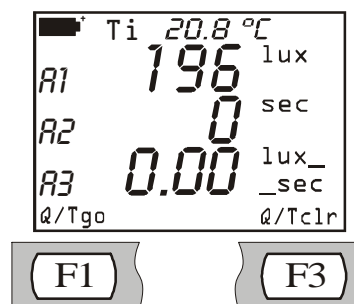

Supposing that one only probe is connected to input A of the multifunction instrument, the initial screen page will be the same as the one shown above. A1 represents the current value provided by the probe, A2 indicates the integration time and A3 the value of the integral calculated on variable A1.

If you press <F3>, A2 and A3 are brought to zero. To start integration, press <F1> function key: if no mains external power supply is connected, a “B” will flash to indicate that the integral calculation is in progress. Integration calculation can be stopped at any time by pressing <F2> Q/Tstop function key: in this situation and by pressing Q/Tgo again, the integration will re-start.

If one or more limits have been activated in the menu, when the first one is reached, counting will stop and the indication "Q/T Time limit" will flash: A2 represents the time lapsed since counting was started, A3 represents the value of the calculated integral.

As the integration process develops through discreet steps, the value of A3 at which integration has to be stopped will not correspond exactly to the set limit, but will correspond to the first integration value coming after this limit.

### Instrument Operation with Several Probes Connected

As already said, **the integration system provides one only limit time for all of the connected probes and a different integration limit for each probe.**

When the first limit is reached, the relevant indication will be displayed.

If this limit is represented by time, then all integrations are stopped and, scrolling through variables A3, B3 and C3, the values of integrals calculated up to that moment will be displayed.

If the first limit to be met is that of an integration, then variable 2 of that input (i.e.: A2 in the case of a probe connected to input A) provides the time needed by the integral to achieve the set limit. The calculation of the other integrals goes on and will stop only when reaching respective limits or set time (the first one to be met).

### Logging Function

When a light probe is connected, logging function is linked to integration function in this way: when logging is started, integration time and calculated integral values are set to zero and the calculation of a new integration is started.

This operation takes place both by immediate logging (<2/LOG> key pressed) and by recorded logging (by entering start and stop date and time), **provided that the instrument is set to remain always on.**

Actually, having to calculate the integral every second, it is necessary that the instrument does not switch off. Thus, use a logging interval lower than 60 seconds, or, if logging interval is higher than or equals 60 seconds, set "Self shut\_off mode" function of “Logging” menu on “...stay on between samples”.

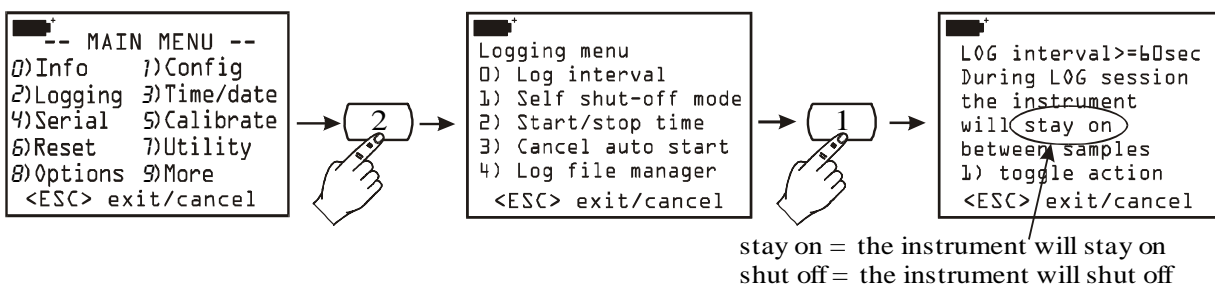

If the instrument is set to shut off between two subsequent acquisitions, only the instant value of the signal provided by the light probe will be logged.

## TECHNICAL SPECIFICATIONS OF PROBES EQUIPPED WITH SICRAM MODULE

### LP 471 PHOT ILLUMINANCE Probe Equipped with SICRAM Module (Specifications refer to the instrument combined to the module)

Measuring Range (lux):	0.01...199.99	...1999	...19.99·10 <sup>3</sup>	...199.9·10 <sup>3</sup>
Resolution (lux):	0.01	1	0.01·10 <sup>3</sup>	0.1·10 <sup>3</sup>
Spectral Response Range:	follows photopic standard curve V( $\lambda$ )			
Calibration Uncertainty:	<4%			
f <sub>1</sub> (Follows Photopic Response V( $\lambda$ )):	<8%			
f <sub>2</sub> (Cosine Response):	<3%			
f <sub>3</sub> (Linearity):	<1%			
f <sub>4</sub> (Display Unit Error):	<0.5%			
f <sub>5</sub> (Fatigue):	<0.5%			
Operating Temperature:	0...50°C			

### LP 471 LUM 2 LUMINANCE Probe Equipped with SICRAM Module (Specifications refer to the instrument combined to the module)

Measuring Range (cd/m <sup>2</sup> ):	0.1...1999	...19.99·10 <sup>3</sup>	...199.9·10 <sup>3</sup>	...1.999·10 <sup>6</sup>
Resolution (cd/m <sup>2</sup> ):	0.1 / 1	0.01·10 <sup>3</sup>	0.1·10 <sup>3</sup>	0.001·10 <sup>6</sup>
Field of View:	2°			
Spectral Response Range:	follows photopic standard curve V( $\lambda$ )			
Calibration Uncertainty:	<5%			
f <sub>1</sub> (Follows Photopic Response V( $\lambda$ )):	<8%			
f <sub>3</sub> (Linearity):	<1%			
f <sub>4</sub> (Display Unit Error):	<0.5%			
f <sub>5</sub> (Fatigue):	<0.5%			
Operating Temperature:	0...50°C			

#### Typical Response Curve

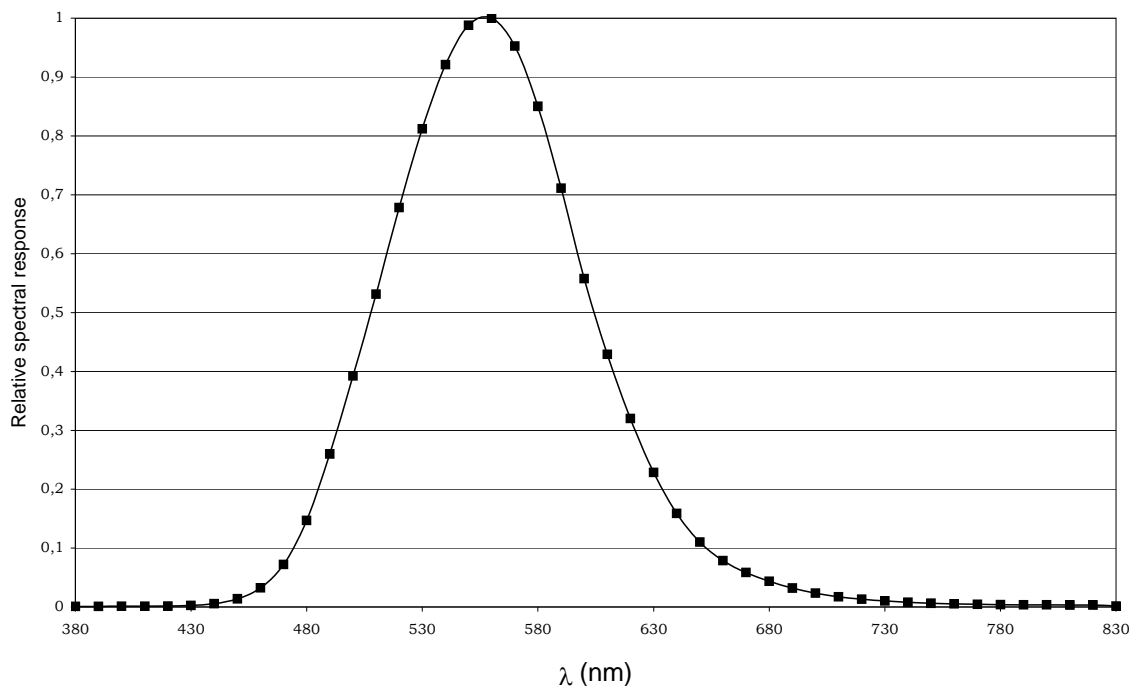



**LP 471 RAD IRRADIANCE Probe Equipped with SICRAM Module**  
**(Specifications refer to the instrument combined to the module)**

Measuring Range (W/m <sup>2</sup> ):	0.1·10 <sup>-3</sup> ... 1.999	...19.99	...199.9	...1999
Resolution (W/m <sup>2</sup> ):	0.1·10 <sup>-3</sup> / 0.001	0.01	0.1	1
Spectral Response Range:	400nm...1050nm			
Calibration Uncertainty:	<5%			
Cosine Response:	<6%			
Linearity:	<1%			
Display Unit Error:	±1digit			
Fatigue:	<0.5%			
Operating Temperature:	0...50°C			

*Typical Response Curve*

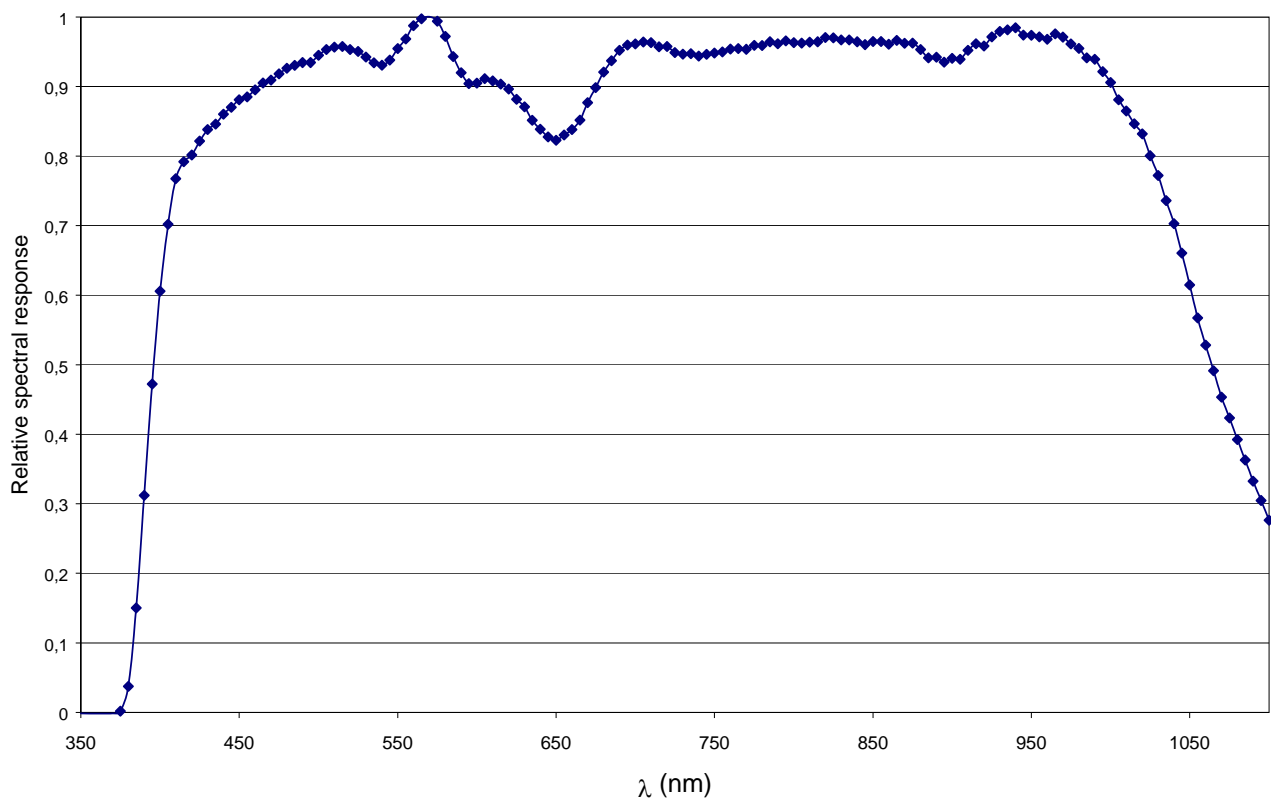

**PAR LP 471 PAR Quantum-Radiometric Probe for Measuring Chlorophyll Photon Flow,  
Equipped with SICRAM Module  
(Specifications refer to the instrument combined to the module)**

Measuring Range ( $\mu\text{mol}/\text{m}^2\text{s}$ ):	0.01... 19.99	...199.9	...1999	... $9.99 \cdot 10^3$
Risoluzione ( $\mu\text{mol}/\text{m}^2\text{s}$ ):	0.01	0.1	1	$0.01 \cdot 10^3$
Spectral Response Range:	400nm...700nm			
Calibration Uncertainty:	<5%			
Cosine Response:	<6%			
Linearity:	<1%			
Display Unit Error:	$\pm 1$ digit			
Fatigue:	<0.5%			
Operating Temperature:	0...50°C			

*Typical Response Curve*

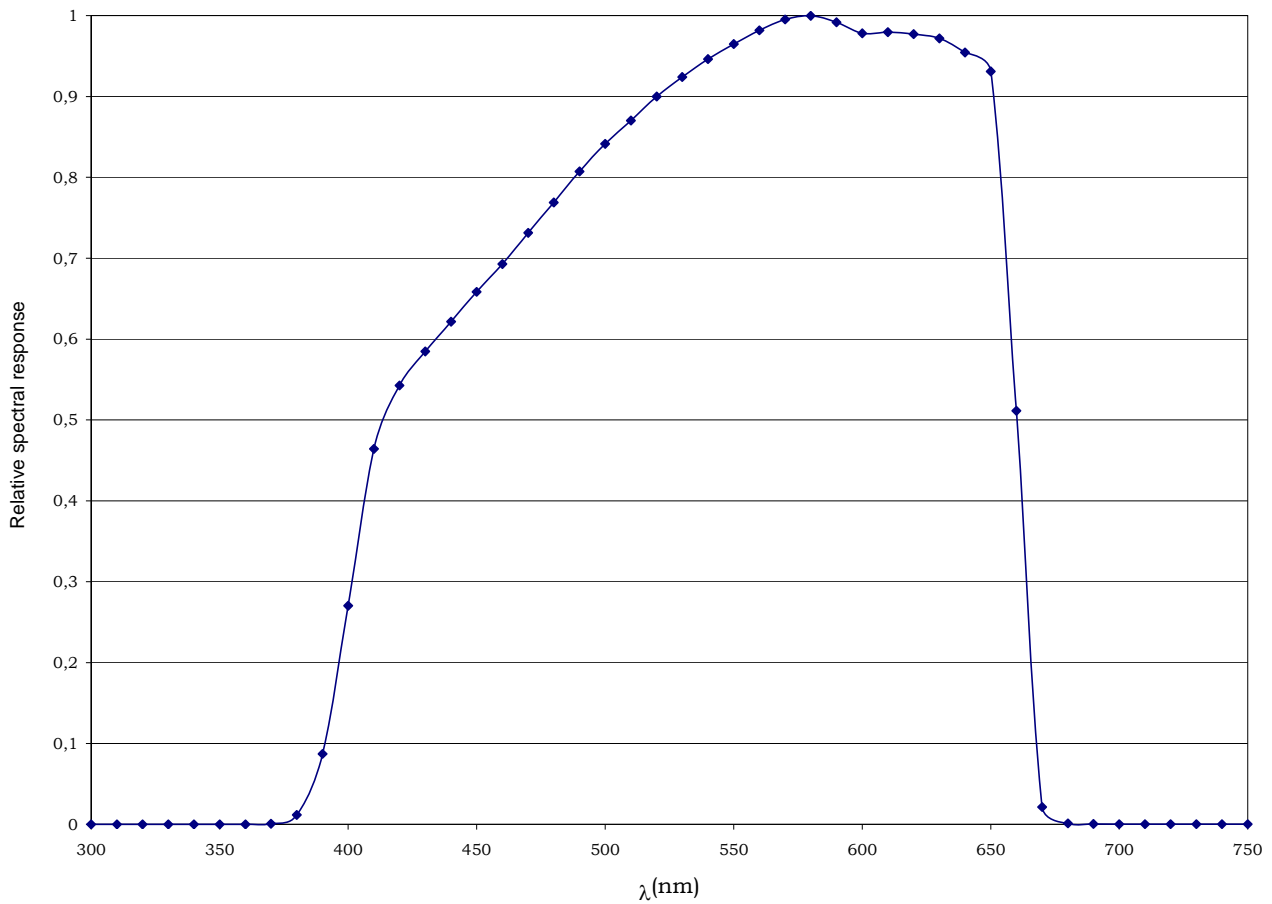

**LP 471 UVA IRRADIANCE Probe Equipped with SICRAM Module**  
**(Specifications refer to the instrument combined to the module)**

Measuring Range (W/m <sup>2</sup> ):	0.1·10 <sup>-3</sup> ... 1.999	...19.99	...199.9	...1999
Resolution (W/m <sup>2</sup> ):	0.1·10 <sup>-3</sup> / 0.001	0.01	0.1	1
Spectral Response Range:	315nm...400nm (Peak 360nm)			
Calibration Uncertainty:	<5%			
Cosine Response:	<6%			
Linearity:	<1%			
Unit Display Error:	±1digit			
Fatigue:	<0.5%			
Operating Temperature:	0...50°C			

*Typical Response Curve*

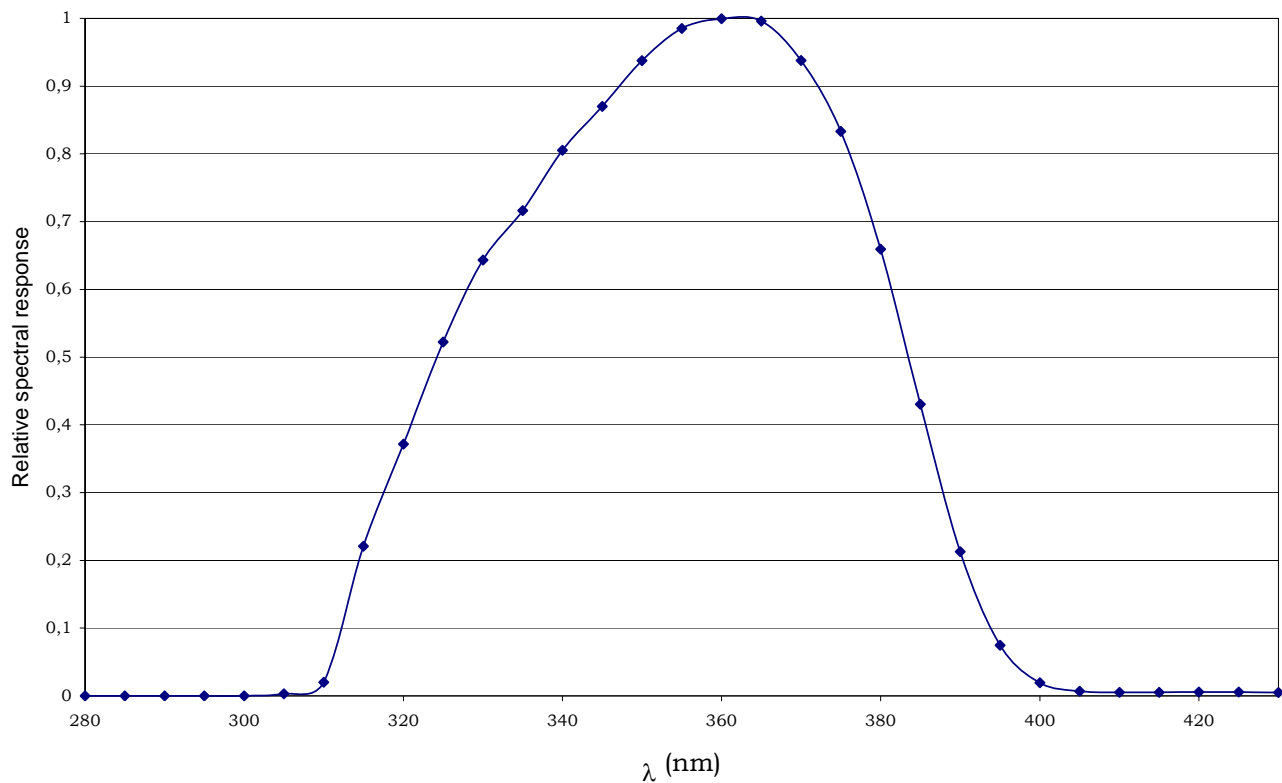

**LP 471UVB IRRADIANCE Probe Equipped with SICRAM Module**  
**(Specifications refer to the instrument combined to the module)**

Measuring Range (W/m <sup>2</sup> ):	0.1·10 <sup>-3</sup> ... 1.999	...19.99	...199.9	...1999
Resolution (W/m <sup>2</sup> ):	0.1·10 <sup>-3</sup> / 0.001	0.01	0.1	1
Spectral Response Range:	280nm...315nm (Peak 305nm)			
Calibration Uncertainty:	<5%			
Cosine Response:	<6%			
Linearity:	<1%			
Unit Display Error:	±1digit			
Fatigue:	<0.5%			
Operating Temperature:	0...50°C			

*Typical Response Curve*

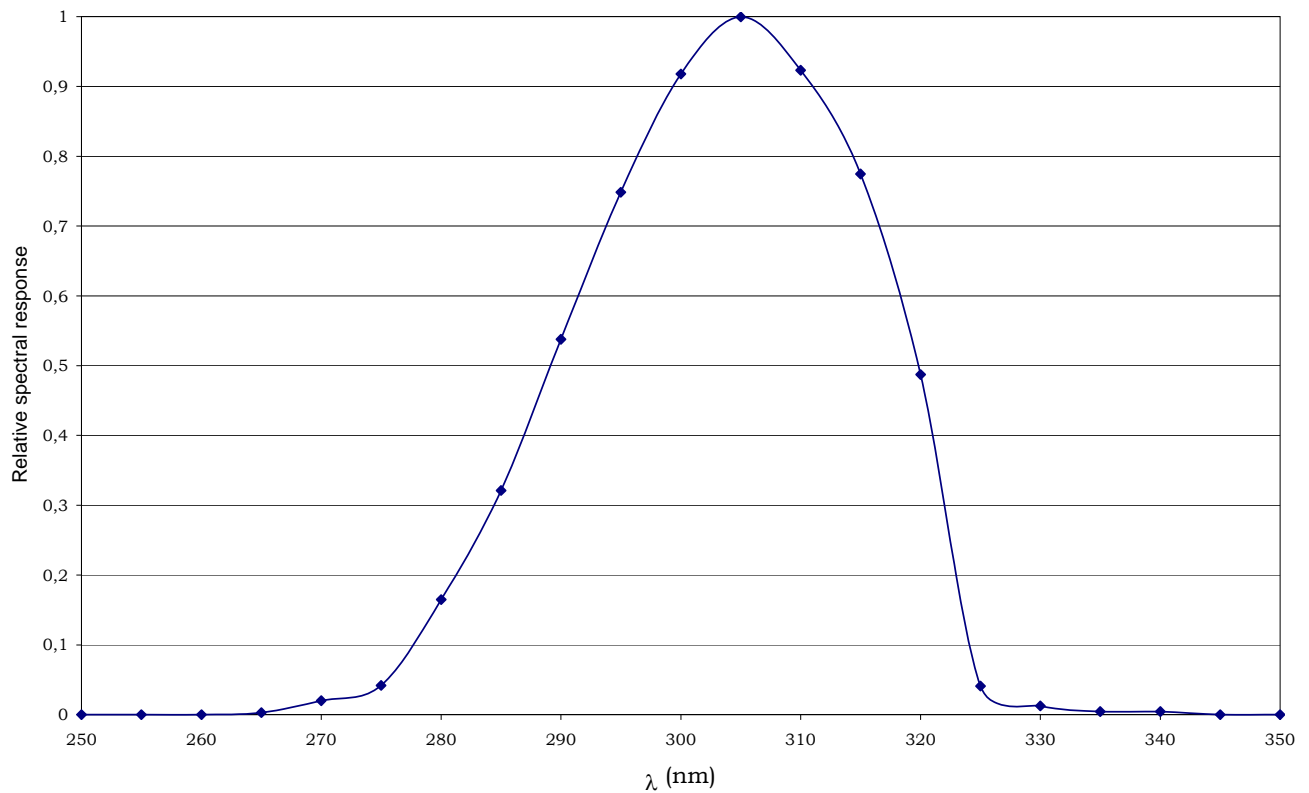

**LP 471UVC IRRADIANCE Probe Equipped with SICRAM Module**  
**(Specifications refer to the instrument combined to the module)**

Measuring Range (W/m <sup>2</sup> ):	0.1·10 <sup>-3</sup> ... 1.999	...19.99	...199.9	...1999
Resolution (W/m <sup>2</sup> ):	0.1·10 <sup>-3</sup> / 0.001	0.01	0.1	1
Spectral Response Range:	220nm...280nm (Peak 260nm)			
Calibration Uncertainty:	<5%			
Cosine Response:	<6%			
Linearity:	<1%			
Unit Display Error:	±1digit			
Fatigue:	<0.5%			
Operating Temperature:	0...50°C			

*Typical Response Curve*

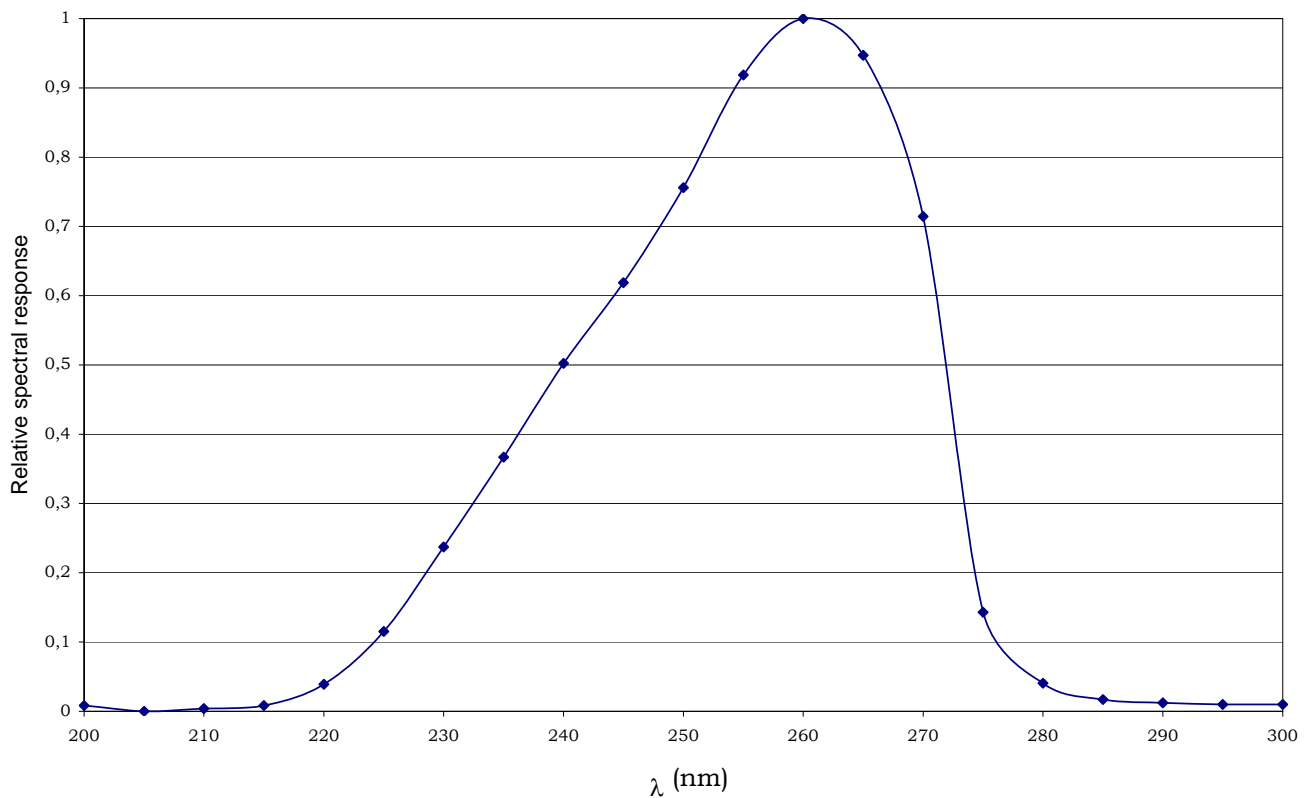

**ELECTRONIC MODULES VP473 AND IP472 FOR MEASURING VOLTAGE AND CONTINUOUS CURRENT**

SICRAM module **VP473** read the continuous current applied at the input in the measuring range from -20Vdc to +20Vdc with a input slope of 1MΩ. If it is connected to the output of a transmitter with voltage signal, it can read and measure the relevant value.

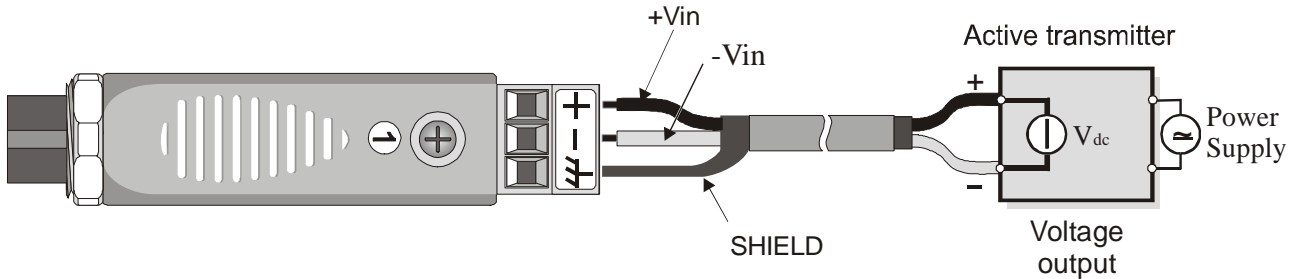

Module connections VP473 to an active transmitter with voltage output

The module SICRAM **IP472** read the continuous current applied at its input in the range 0...24mA with a input slope of 25Ω. The typical application is the reading and storing of output signal of a active or passive current transmitter as per the following drawings:

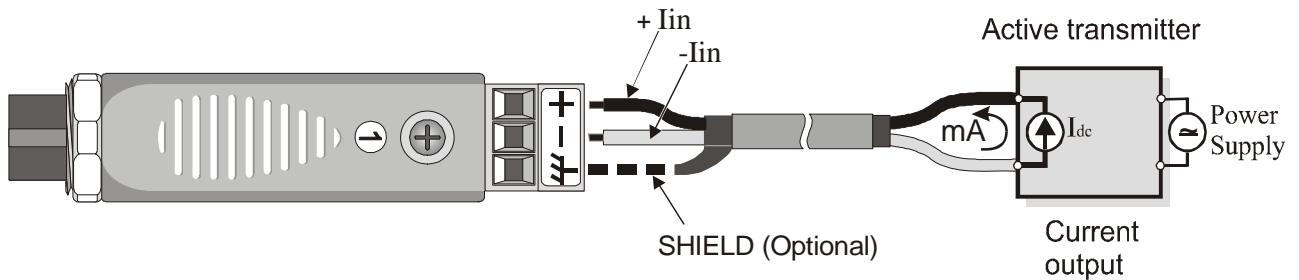

Connections of IP472 module to an active transmitter with current output.

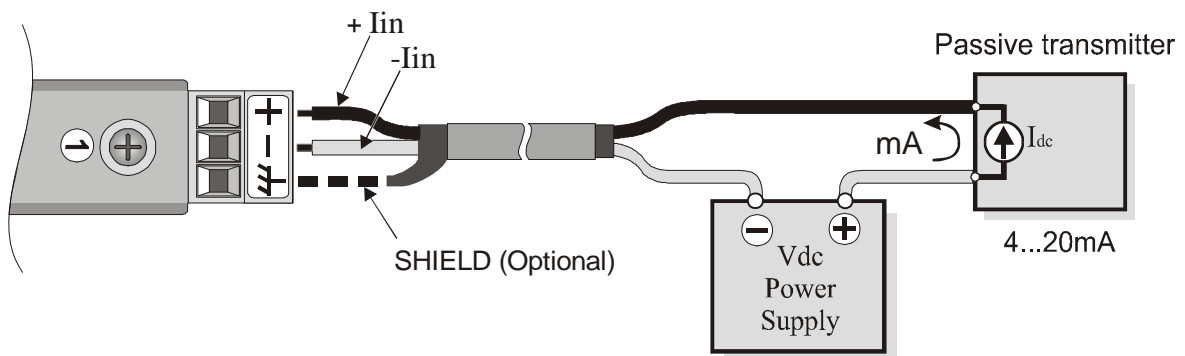

Connections of IP472 module to a passive transmitter with current output 4...20mA.

## UPDATING FIRMWARE

The firmware, that is the programme which manages all the instrument functions, may be updated by transferring the file to the DO9847 through the serial port RS232C. In this way it is possible to add new types of probes or to update the functionality of the instrument. The update files are available from authorised dealers.





To update firmware, you need DeltaLog3 program to be installed on your PC, as well as a DO9847 unit, version 2.0 or higher. See “DeltaLog3 Handbook” online manual for details concerning this procedure. DO9847 units having a version prior to 2.0, can be upgraded directly by DeltaOhm.

## METHOD OF USING THE INSTRUMENT AND WARNINGS



1. Do not expose the probes to gases or liquids that could corrode the material of the sensor or of the probe; clean the probe carefully after measurement.
2. Do not bend the connectors applying upward or downward force.
3. Do not bend or force the contacts when inserting the probe connector in the instrument.
4. Do not bend, deform or drop the probes as this could cause irreparable damage.
5. Always use the most suitable probe for the measurement to be taken.
6. Temperature probes are not generally used in the presence of corrosive gases or liquids; the container in which the sensor is housed is made of stainless steel AISI 316, while the container for the contact probe is of AISI 316 plus silver. Do not let the surfaces of the probe come in contact with sticky surfaces or with substances that can corrode or damage the probe. If the sensor breaks or becomes faulty it must be replaced. In this case the probe must be recalibrated.
7. Above 400°C and below -40°C avoid violent blows or thermal shock to the Pt100 temperature probes as these could cause irreparable damage.
8. To obtain a reliable temperature measurement, too fast temperature variations must be avoided.
9. Temperature probes for surface measurements (contact) must be held in a vertical position with respect to the surface. Apply a some oil or heat-conductive paste between the surface and the sensor so as to improve contact and reduce the reading time. Do not absolutely use water or solvents to do this.
10. Measurements on non-metal surfaces require a great deal of time on account of their low heat conductivity.
11. The probes are not insulated from their external casing. Be very careful not to come into contact with live parts (above 48 V): this could be dangerous not only for the instrument but also for the operator, who could suffer an electric shock.  

12. Avoid taking measurements in the presence of high frequency sources, microwaves or large magnetic fields, as the results would not be very reliable.
13. Always clean the probes carefully after use.
14. The instrument is resistant to water but it is not watertight and should not therefore be immersed in water. If it should fall into the water, take it out immediately and check that no water has infiltrated. The instrument must be handled in such a way that water cannot get in through the connector side.

## INSTRUMENT SIGNALS AND MALFUNCTIONS

The following table lists the indications given by the instrument in the various operating situations: from the explanations about a function active at a given moment to error signals and indications supplied to the user. Where contemplated, it also gives references to the pages in the manual where the various functions are explained in detail.

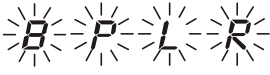
<b>ERR</b>	The probe at the input next to which the message appears has been disconnected, or is badly inserted.
<b>NOMEAS</b>	It appears when printing data files if no probe is available for that input.
<b>OVFL</b>	Measurement overflow: indicates that the probe is measuring a value that exceeds the contemplated full-scale value.
<b>UDFL</b>	Measurement underflow: indicates that the probe is measuring a value below the contemplated start-of-scale value.
<b>MEMORY FULL</b>	Memory full; indicates that the instrument cannot store any more data as its memory space is full. ( <i>See the function "Log File Manager" on p.20</i> )
	The automatic cut-out after 8 minutes of inactivity had been disabled. The instrument will stay on and can be switched off only by the <On/Off> key. ( <i>See the function "AutoPowerOff" on p.5</i> )
	The "Screen" function is active or the "ALL" function for transferring data to a computer: press the key <4/SERIALOUT> and then <b>F1</b> (Stop printing) to stop. If an external power supply is connected, only the letter "P" will flash. ( <i>See the functions "Screen" and "ALL" from p.90</i> )
	The Record function (<6/RCD> key) is active: press the <6/RCD> key and then <b>F2</b> (rcdSTOP) to complete the rcdGO function or the F3 key (rcdCLR) to complete the M(n=00) function. If the outer power supplier is connected, only the letter 'M' appears or the letter 'R' flashes. ( <i>See the RCD functions from page 86</i> )
	The "RCD+" function for transferring data to a computer is active (key <4/SERIALOUT> → key <F2>). To stop, press the key <4/SERIALOUT> and then <b>F1</b> . If an external power supply is connected, only the letter "P" and the letter "R" will flash. ( <i>See the function "RCD+" on p.91</i> )
	The data logging function is active: press the key <2/LOG> to stop. If an external power supply is connected, only the letter "L" will flash. ( <i>See the function "Logging" on p.88</i> )



	<p>The functions Logging (key &lt;2/LOG&gt; and Record (key &lt;6/RCD&gt;) are active at the same time. To end the Logging function press the key &lt;2/LOG&gt;. To end the Record function, press the key &lt;6/RCD&gt; and then the function key &lt;F2&gt;– <i>rcdSTOP</i> –. (See the “Logging” function on p.88 and the function Record on p.86).</p>
	<p>The Logging function (key &lt;2/LOG&gt;) and the immediate printing sub-function RCD+ (key &lt;4/SerialOut&gt; → key &lt;F2&gt;) are active at the same time. To end the Logging function press the key &lt;2/LOG&gt;. To end the sub-function RCD+, press the key &lt;4/SerialOut&gt; and then the function key &lt;F1&gt; – STOP printing –. (See the “Logging” function on p.88 and the RCD+ function on p.91).</p>
	<p>The Logging function (key &lt;2/LOG&gt;) and one of the two sub-functions for immediate printing, <i>Screen</i> (key &lt;4/SERIALOUT&gt; → key &lt;F1&gt;) or <i>Rawdata</i> (key &lt;4/SERIALOUT&gt; → key &lt;F1&gt;), are active at the same time. To end the Logging function press the key &lt;2/LOG&gt;. To end the sub-functions <i>Screen</i> or <i>Rawdata</i>, press the key &lt;4/SERIALOUT&gt; and then the function key &lt;F1&gt;– <i>STOP printing</i> –. (See the Logging function on p.88, the Screen function on p.90 and the Rawdata function on p.92).</p>
	<p>Automatic starting of the Logging function has been set. (See the function “Start/Stop time” on p.18)</p>
<p><b>r</b></p>	<p>With the SICRAM pressure module PP471, indicates a relative measure (See the chapter “PP471 ELECTRONIC MODULE FOR PRESSURE MEASUREMENT”)</p>
<p><b>WARNING! CHANGE OF PROBES DETECTED – Press NOW any key to choose settings or wait to self-config</b></p>	<p>This message appears when switching on the machine or leaving the menu, when a variation is detected at the inputs because a probe has been connected or removed. (See on p.28 the introduction to the chapter on probes).</p>
<p><b>COM FAILURE</b></p>	<p><i>Communication failure.</i> This message appears when, once the instrument is already on, a module is disconnected: the instrument consequently indicates that there is no communication with the involved channel.</p>
<p><b>LOW BATTERY</b> <i>Log refused</i></p>	<p>Logging cannot be started as the battery level is too low.</p>

## LOW BATTERY WARNING AND BATTERY REPLACEMENT

The battery symbol  situated in the top left-hand corner of display constantly indicates the state of charge of the batteries in the instrument. As the batteries run low, the symbol gradually "empties" ...



... when the voltage of the batteries has reached the limit value of 4.4 Volt, the symbol flashes. In these conditions the batteries should be replaced as soon as possible.

If you continue to use the instrument and the battery voltage falls as low as 4.0V the instrument is no longer able to ensure correct measurement. The data in the memory are not lost.

**If the instrument is logging and battery voltage falls under the minimum operating level, logging will be stopped to avoid losing data. In this case, a message indicating that logging has been interrupted due to low battery reasons will appear on display and on the printout of acquired data: "Stop code=low\_batt" on display and "Log stopped on low battery" on the printout.**

The battery symbol changes to [~] when an external power supply is connected.

To change the battery switch off the instrument, then turn the two retaining screws of the battery compartment cover in an anti-clockwise direction. After replacing the batteries (4 1.5V alkaline batteries - type AA) close the cover and turn the two screws in a clockwise direction.

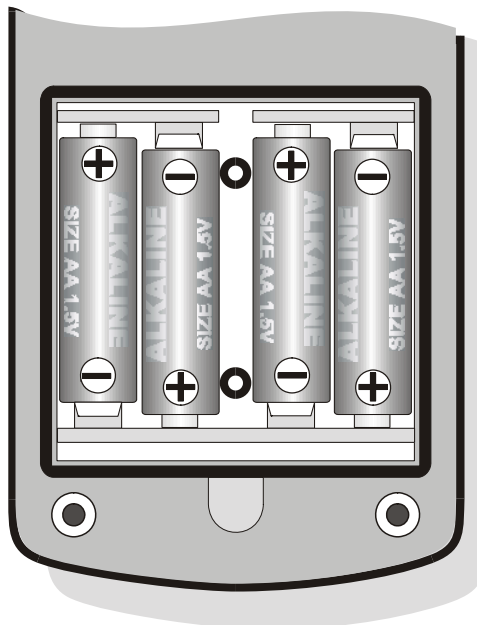

You will have to reset the time, the date, the configurable options with password (the password is returned to the default value 12345678), the baud rate, the print interval, the logging parameters: to simplify the operation, when the new batteries are fitted the instrument switches on automatically and asks for all these parameters in sequence.

### **FAULTY OPERATION WHEN SWITCHING ON AFTER CHANGING THE BATTERIES**

After the batteries have been changed, it is possible that the instrument may not start again correctly. In this case it is advisable to repeat the operation. Wait a few minutes after disconnecting the batteries, to allow the circuit condensers to be completely discharged, then insert the batteries.

### **WARNING ON USE OF THE BATTERIES**

- If the instrument is not to be used for a long time the batteries must be removed.
- If the batteries are flat they must be replaced immediately.
- Take steps to avoid leakage of liquid from the batteries.
- Use good quality leak proof batteries, alkaline if possible.

## **STORAGE OF THE INSTRUMENT**

Instrument storage conditions:

- Temperature: -25...+65°C.
- Humidity: less than 90% RH, avoid the formation of condensation.
- Do not store the instrument in places where:
  1. there is a high degree of humidity.
  2. the instrument is exposed to direct sunlight.
  3. the instrument is exposed to a source of high temperature.
  4. there are strong vibrations.
  5. there is steam, salt and/or corrosive gas.

The instrument case is made of ABS plastic and the protection strip against impact is made of rubber: do not use any solvent to clean them.

## SERIAL INTERFACE RS232C

The instrument is equipped with a standard serial interface RS-232C, galvanically insulated; the instrument is supplied with a null-modem cable having sub D 9-pole female connectors (code **9CPRS232**).

The following signals are available on the SUB D 9-pin male connector of the instrument:

Pin	Signal	Description
2	RD	Datum received by the instrument
3	TD	Datum transmitted by the instrument
4	DTR	Data terminal ready
5	GND	Reference logic mass
7	RTS	Request transmission

Also available on request is a second serial cable (code **CPRS232 C**) with a sub D 9-pole female connector and a sub D 25-pole female connector with commutator for inverting lines 2 and 3: this cable must be used in PCs without a 25-pole serial output or for connection to a serial printer.

Note: the deflector on the 25-pole connector of CP RS232 C optional cable must be turned to COMPUTER or PRINTER position, depending on the chosen connector (this may not be true on some computers or printers).

The standard serial transmission parameters of the instrument are:

- Baud rate 19200 baud
- Parity None
- N. bit 8
- Stop bit 1
- Protocol Xon / Xoff.

The data transmission velocity may be changed by adjusting the "*Baudrate*" parameter on the menu – item "*Serial*" (*see p.22*). The possible baud rates are: 115200, 38400, 19200, 9600, 4800, 2400, 1200, 600, 300. The other transmission parameters are fixed.

The DO9847 is able to respond to numerous commands sent directly to it by means of the serial port: as may be seen in the table below, these are requests for information on the type of instrument, on the version and date of the firmware, and on the values detected, at the time of sending the command, by the probes connected to the three input channels.

All the commands transmitted to the instrument must have the following structure:

**XYcr** where **XY** constitutes the command code and **cr** Carriage Return (ASCII 0D).

Command	Response	Notes
AA	MULTIFUNCTION Data Logger	Type of instrument
AG	Vx Rx	Firmware Version
AH	issued dd/mm/yy	Firmware Date
AS	Serial Number	Serial Number of the instrument
AZ	Complete heading	Supply information about the instrument and the connected modules.
FA	Current date	
FB	Logging start date	
FC	Logging Stop date	
FD	Calibration date	
K1	Print SCREEN	Serial Out → Screen command
K2	Print RCD+	Serial Out → RCD+ command
K3	Print ALL	Serial Out → ALL command

Command	Response	Notes
KS	Measur. indication of each channel: A1, A2, ..., C3, Ti	
LD##	Log dump. To download the data file n°##	## = 00 ... 15 (See Note n.1)
LL	Log list.	List of stored files.
LX	Detailed list of stored logging files	
P0	Character &	To check the connection
RA	Print interval	
RB	Logging interval	
RP	Battery level	It goes from &01 (completely down) to &06 (completely full). &07: external power supplier.
SA	String of 10 characters containing value and measuring unit of channel A1	Print channel A1 for example: ..100.41°C
SB	as above channel A2	Print channel A2
SC	as above channel A3	Print channel A3
SD	as above channel B1	Print channel B1
SE	as above channel B2	Print channel B2
SF	as above channel B3	Print channel B3
SG	as above channel C1	Print channel C1
SH	as above channel C2	Print channel C2
SI	as above channel C3	Print channel C3
SJ	as above for the difference A1-B1	Print the difference A1-B1
SK	as above for the difference A1-C1	Print the difference A1-C1
SL	as above for the difference B1-C1	Print the difference B1-C1
SM	as above for the internal temperature Ti	Print the internal temperature Ti

Note 1: This command works only from menu: use the KM command to open the menu.

Command	Description	Note
DAy m d h m	set the date (year month day) and current time (hour and minute)	Insert a blank between the variables. (for example DA2002 02 15 17 55).
DBy m d h m	Set the date (year month day) and the logging start time (hour and minute)	As above
DCy m d h m	Set the date (year month day) and the logging stop (hour and minute)	As above
K0	Stop Print	
K4	Start logging	
K5	Stop logging	
K6	Starting of postponed logging	
K7	Cancel of postponed logging	
K8	Log mode = SCREEN	
K9	Log mode = ALL	
KA	Lock reserved function	
KB	Unlock reserved function	
LE##	Log erase. Cancel the data file n°##	## = 00 ... 15.
WA #####	Set the printing interval	##### = 0001 ... 3600
WB #####	Set the logging interval	##### = 0001 ... 3600
Xoff (ctrl-S)	Stop transmission	
Xon (ctrl-Q)	Resume transmission	

Command characters are exclusively upper case, the instrument replies with & if the command is correct, and with a “?” to any wrong combination of characters.

## THE FUNCTIONS OF STORING AND TRANSFERRING DATA TO A PERSONAL COMPUTER

The DO9847 multifunction datalogger may be connected to a personal computer by means of the RS232C serial port and exchange data and information by means of the program Delta Ohm DeltaLog3® which operates in a Windows environment or with HyperTerminal. The DO9847 can send the values measured by the three inputs directly to the PC in real time using the functions that may be activated with the key <4/SERIALOUT> or it can store in its internal memory the data measured with the *Record* function (key <6/RCD>) and the *Logging* function (key <2/LOG>): in the second case the stored data may be transferred to the PC later.

### THE RECORD FUNCTION

The *Record* function stores in the memory the **maximum**, **mean** and **minimum** values of the measurements of the three channels and updates them when new samples are logged. There are two logging functions: one at fixed time interval (equal to one second) and one 'with command'. The first function is activated with the command *rcdGO* (key <F1>) and terminated with the command *rcdSTOP* (key <F2>): each second the values of the two inputs are measured and the maximum, mean and minimum values updated.

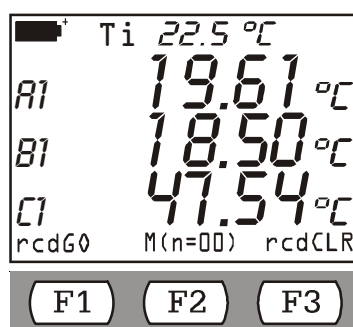

The 'Command Record' is activated with the F2 function key. Unlike the *rcdGO* function where the interval sampling is one second, with this function a new sample is logged each time the F2 key is pressed. For each new logged sample, the heading M(n=00), which is in the middle of the controls bar, increase of a unit.

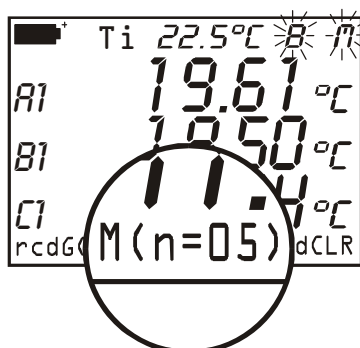

The logged data increase the ones which are already logged; therefore it is necessary to cancel the previous values with the *rcdCLR* key (<F3> key) before starting with a new measurement cycle.

Using the command *DATA CALL* (key <5/DATA CALL>) the minimum - *min* - function key <F1>, maximum - *max* - function key <F2> and mean - *avg* - function key <F3> values for all the data present in the memory are called directly to the display: this may be done after having concluded

the measuring session or, in real time, by pressing first the key F1 <rcdGO> to start the recording and then viewing the max, min and avg data with the key <5/DATA CALL>.

The example below shows the steps necessary to:

1. start the RCD function
2. erase the memory of the previous data,
3. start a new recording session
4. view in real time the MAX value of the three inputs (which in this case are three temperatures)
5. conclude the recording and return to normal measurement

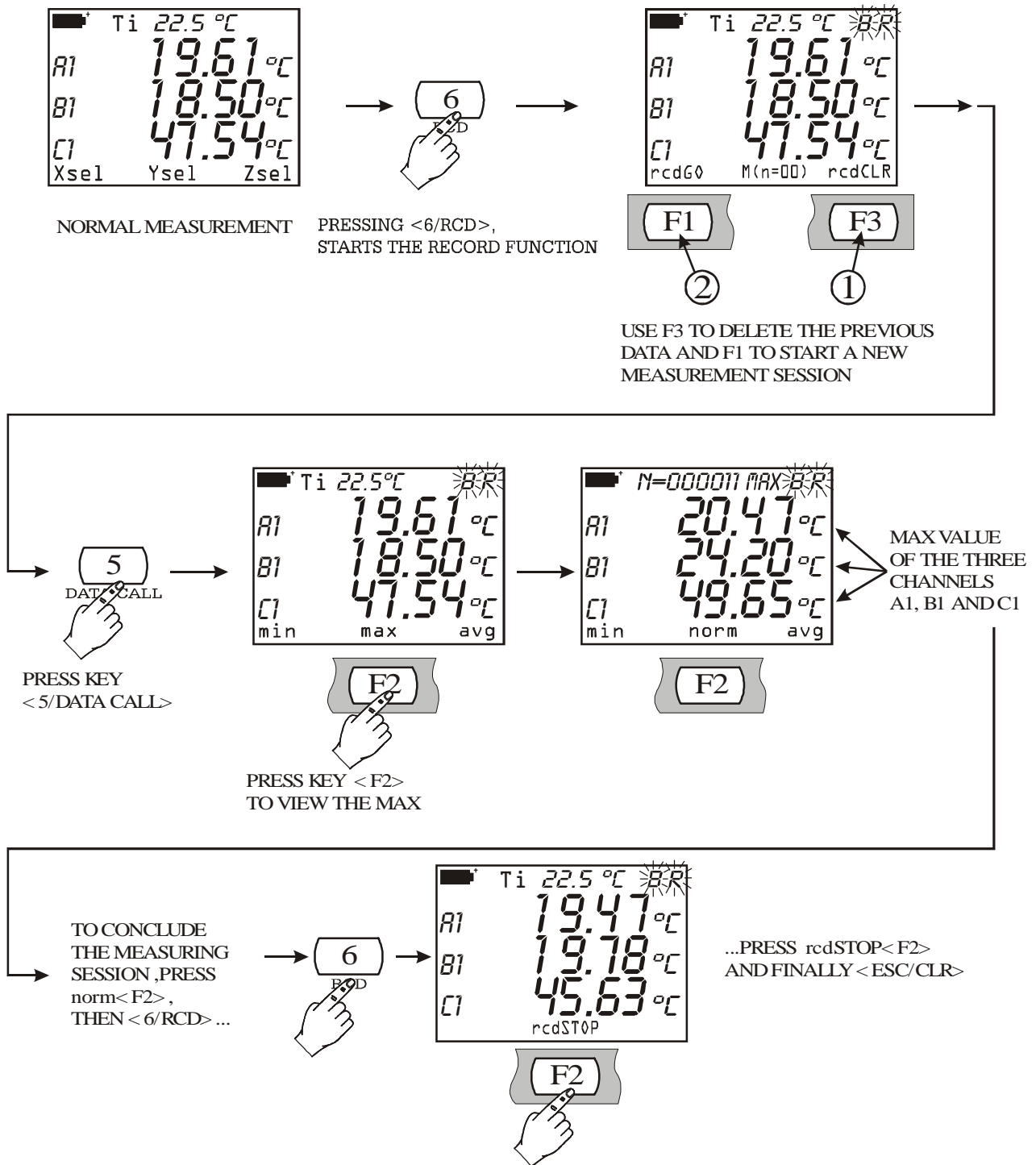

**Attention: the data obtained with the Record function cannot be transferred to the PC.**

## THE LOGGING FUNCTION

The *Logging* function allows the recording of up to 32,000 measurements from the three input channels in the internal memory of the instrument with a time interval between two consecutive measurements which may be set from 1 to 3600 seconds. The data in the memory may be transferred to the PC by means of the command on the Menu “*Log File Manager*”: key <MENU> >> 2) Logging >> 4) Log File Manager.

The logging function may be started and stopped immediately by the user, by pressing the key <2/LOG>, or after a time delay: the date and time of starting and stopping logging may be set in advance by the user. In the latter case the logging start and stop commands are given by the instrument.

The diagram below shows the steps for starting and stopping immediate logging.

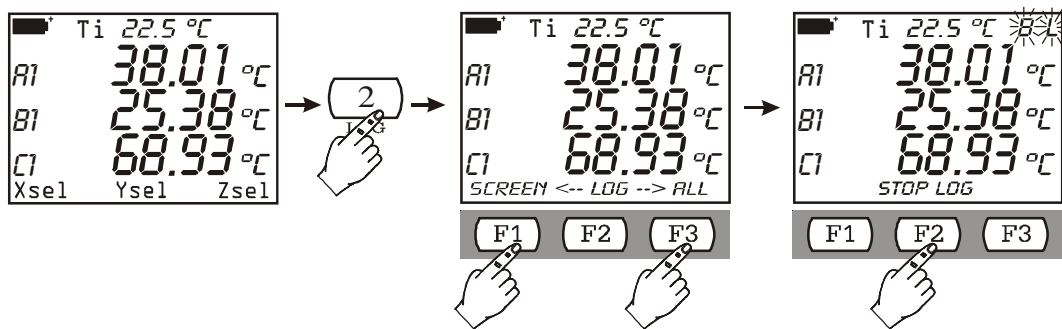

When pressing the <2/LOG> key the above screen which is in the middle appears. The logging of the data which correspond to the displayed variables is activated with the F1 (SCREEN) function key: in this case the variables A1, B1 and C1 are stored. The logging of all the inputs A1, A2, ..., C3 and also the internal temperature is activated with the F3 (ALL) function key.

Press the <F2> 'Stop Logging' function key to manually stop the logging.

If after having pressed the key <2/LOG> you **do not** want to proceed with logging, it is sufficient to press the clear key <ESC/CLR>.

The display of data with HyperTerminal with the LOG>>ALL function is the same as the table below:

Date	Time	A1	A2	A3
		B1	B2	B3
		C1	C2	C3
		Ti		

Note: as the variables are more than the ones which can be simultaneously displayed, the LOG>>ALL logging function of the ‘VIEW SELECTED LOG’ File Manager function cannot be activated: when a logged file is selected with the LOG>>ALL function the message “**NON\_VIEW! (Print only)**” appears. In this case use the “PRINT SELECTED LOG” function to print the data.

The LOG>>ALL function logs 5 measurements each page, for a total number of 10.000 measurements (5 measurements each 2000 pages).

The settings of the parameters for all the logging functions are in the MENU under the item *Logging* (see p.17 for a detailed description).

Below are some examples of the use of the Logging function, explained step by step.



*Example 1:*

you want to log the trend of three quantities (for example three temperatures) with an interval of 10 seconds; start and stop commands are given by the operator.

- A) Insert the three probes in the instrument.
- B) Switch on the instrument.
- C) If there has been a change in the probes at the inputs with respect to the previous measuring session, the instrument notifies the operator with the message: “WARNING! *CHANGE OF PROBES DETECTED* – Press NOW any key to choose settings or wait to self-config”. When any key is pressed, the menu is opened in which the instrument configuration parameters can be altered. If you do not think it necessary to change them, it is sufficient to let this time pass to return to standard measuring conditions. (See the introduction to the chapter on probes on p. 28).
- D) Press <MENU> and then <ENTER> to enter the Menu.
- E) Press “2) Logging” and then “0) Log Interval”: set the logging time interval at 10 seconds and then press <ENTER> to confirm.
- F) Press <ESC/CLR> twice to return to normal measurement.
- G) At this point, to start logging, press the key <2/LOG>: press the <F1> function key to start the logging of the variables at the display or <F3> to log all the variables: the letters “L” and “B” flash (or only the letter “L” if an external power supply is being used).
- H) When the desired time has elapsed, press <2/LOG> to end logging.

**Notes:**

- 1) as the logging interval is less than 60 seconds, the instrument does not switch off between one logging operation and the next.
- 2) Switching off the instrument with the <ON/OFF> key ends the current logging session.

*Example 2:*

you want to log the trend of three quantities (for example three temperatures) with an interval of 100 seconds; start and stop commands are given by the instrument; moreover you want the instrument to switch off between two consecutive logging operations to save battery consumption

- A) Insert the three probes in the instrument.
- B) Switch on the instrument.
- C) If there has been a change in the probes at the inputs with respect to the previous measuring session, the instrument notifies the operator with the message: “WARNING! *CHANGE OF PROBES DETECTED* – Press NOW any key to choose settings or wait to self-config”. When any key is pressed within 3 seconds, the menu is opened in which the instrument configuration parameters can be altered. If you do not think it necessary to change them, it is sufficient to let this time pass to return to standard measuring conditions. (See the introduction to the chapter on probes on p. 28).
- D) Press <MENU> and then <ENTER> to enter the Menu.
- E) Press “2) Logging” and then “0) Log Interval”: set the logging time interval at 100 seconds and then press <ENTER> to confirm.
- F) To set self shut-off press “1) Self shut\_off mode”: press the key <1/MATH> until the indication on the display says: “...will shut off...” then press <ESC/CLR> to quit.
- G) There remain to be inserted the date and time of starting and ending logging. Press “2) Start/stop time”: using the arrow keys and the numerical keys, set the date and time of starting, then press <ENTER> to confirm.
- H) Set the date and time of ending, then press <ENTER> to confirm.
- I) The instrument proposes the setting just inserted: press <ENTER> to confirm (or <ESC/CLR> to change it).

- J) Choose if log all the variables A1, A2,...,C3, Ti (option ALL) or only those which are displayed (option SCREEN).
- K) At this point the instrument can be switched off: it will switch on again automatically at the established time and date.

**Notes:**

- 1) Logging stops automatically: to stop it before the established time, switch on the instrument, press the key <2/LOG> and then the function key *StopLog*<F2>.

If you do not want to log the data but to send them directly to the PC in real time, the instrument offers three functions which may be activated with the key <4/SERIALOUT>: the *Screen* function, the *RCD+* function and the *ALL* function.

**THE SCREEN FUNCTION**

The <4/SerialOut> >> <F1/Screen> function sends the values measured by the instrument at its inputs in real time directly to the PC. The printed data are those that appear on the instrument display at the time of pressing the key F1 <Screen>. As shown in the example, it is possible to choose the variables to be printed from the following: A1, A2, A3, B1, B2, B3, C1, C2 or C3, the differences A1-B1, A1-C1 or B1-C1 when they refer to inputs of the same type, the internal temperature of the instrument. The date and time of acquisition are shown next to each line of the table. In this case A1, B1 and C1 have been chosen.

The following details are also provided:

- the serial number and the type of calibration of probes
- reference temperature and pressure (see paragraph “8) Options” at page 26).

The value obtained from the difference between two measurement channels is not shown when probes of different types are connected to the two channels (for example Pt100 and Thermocouple).

Multifunction meter printout / immediate mode  
Instrument serial n° 00001234

Probe A: RTD ser. number 70000005 Calibration mode: Factory  
Probe B: RTD ser. number 70000006 Calibration mode: Factory  
Probe C: RTD ser. number 70000007 Calibration mode: Factory

Printing absolute data

When appropriate, measurements are referred to temperature= 23.0 °C  
and to atm.pressure= 1013.0 mbar

DATE/TIME	Channel:	A1	B1	C1
2001/04/23 10:25:24		27.64°C	21.02°C	20.86°C
2001/04/23 10:25:29		21.91°C	20.92°C	23.19°C
2001/04/23 10:25:34		21.80°C	26.11°C	25.76°C
2001/04/23 10:25:39		21.75°C	28.44°C	25.22°C

Absolute data printed

The function is started by pressing the key <4/SERIALOUT> and then the function key *F1*:

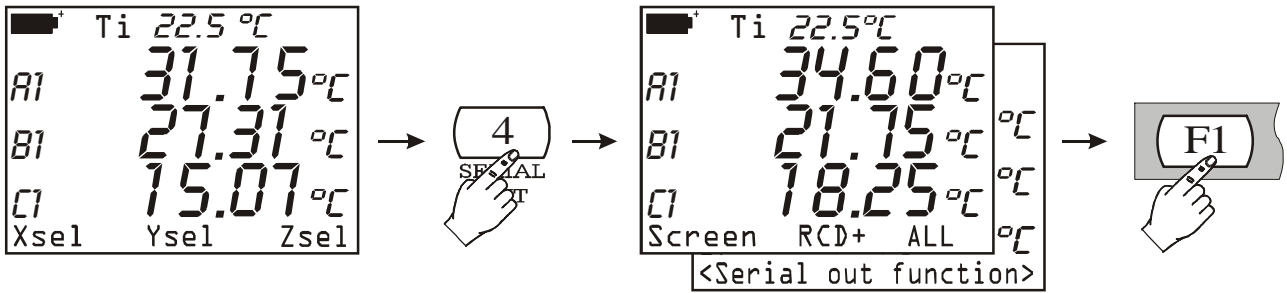

Acquisition continues until the operator interrupts it by pressing the key *F1* <STOP Printing>:

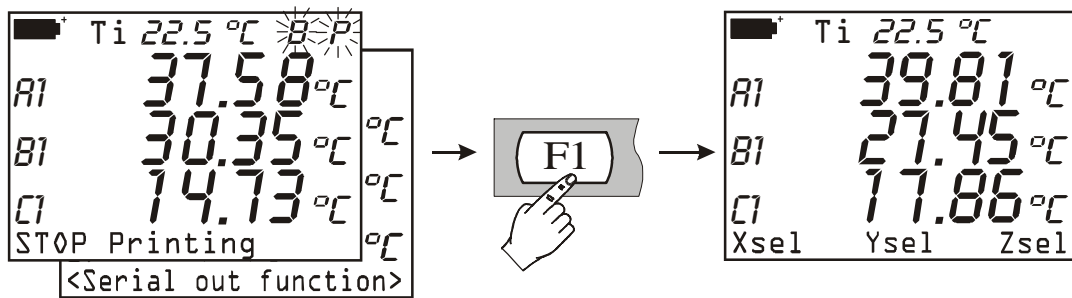

The settings of the parameters for the *Screen* function are in the MENU under the item *Serial* (see p. 22 for a detailed description).

### THE RCD+ FUNCTION

The <4/SerialOut>→<F2/RCD+> function behaves similarly to the *Screen* function with these differences:

- when the <STOP> key is pressed, it supplies the number of samples measured (N samples), the maximum, minimum and mean values of the variables for the 3 columns of data,
- it can record up to a maximum of 100,000 samples.

The function is started by pressing the function key <F2>:

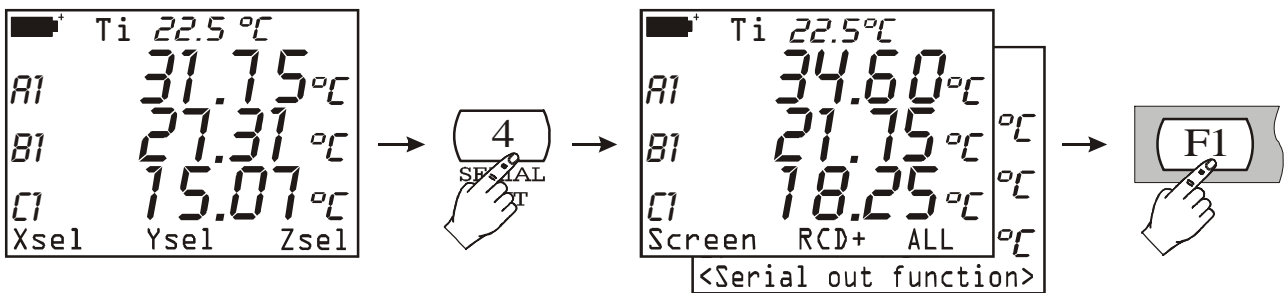

...and ended, like the *Screen* function, by pressing the function key <F1> *STOP Printing*.

Below is an example of the *RCD+* function:

```

Multifunction meter printout / immediate mode
Instrument serial n° 00001234

Probe A: RTD ser. number 70000005 Calibration mode: Factory
Probe B: RTD ser. number 70000006 Calibration mode: Factory
Probe C: RTD ser. number 70000007 Calibration mode: Factory

Printing absolute data
When appropriate, measurements are referred to temperature = 23.0°C
and to atm. Pressure = 1013.0 mbar

DATE/TIME          Channel:  A          B          C
2001/01/01 12:02:24    100.00°C  19.76°C  23.95°C
2001/01/01 12:02:29    100.00°C  19.76°C  23.51°C
2001/01/01 12:02:34    100.00°C  19.76°C  23.17°C
2001/01/01 12:02:39    100.00°C  19.76°C  22.88°C
N samples = 4
MIN =                100.00°C  19.76°C  22.88°C
MAX =                100.00°C  19.76°C  23.95°C
AVG =                100.00°C  19.76°C  23.38°C
Absolute data printed

```

### THE ALL FUNCTION

The <4/SerialOut> → <F3/ALL> function sends the values measured by the 9 inputs of the instrument A1, A2, A3, B1, B2, B3, C1, C2 and C3 and the internal temperature *Ti* in real time directly to the PC. It is not possible to modify the variables to be printed. “NOMEAS” means that no probe is connected to that input or that no measurement is provided.

Each acquisition is preceded by the date and time.

The data are printed according to the table below:

Date	Time	A1	A2	A3
		B1	B2	B3
		C1	C2	C3
		Ti		

When starting the acquisition, the following details are provided:

- probe serial number and calibration type
- temperature and reference pressure (see paragraph “8) Options” at page 26).

To start this function, press <4/SerialOut> and then <F3>/ALL:

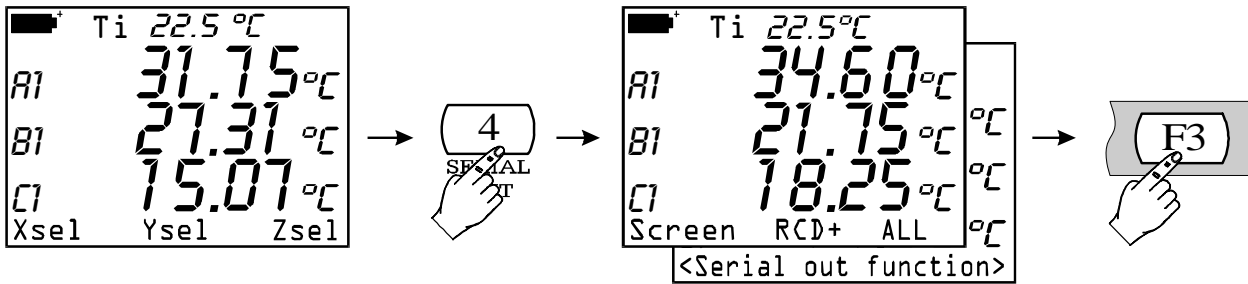

...to stop it, press <F1> *STOP Printing* (just like *Screen* and *RCD+* functions).

```

Multifunction meter printout / immediate mode
Instrument serial n°= 99990005

Probe A: RTD          ser. number 90000002  Calibration mode: User
Probe B: Rh           ser. number 12365478  Calibration mode: standard
Probe C: Double Tc comp ser. number 99999990  Calibration mode: Factory

Printing absolute data
When appropriate, measurements are referred to temperature = 23.0°C
and to atm. Pressure = 1013.0 mbar

2001/07/23  11:02:31  57.3%RH  25.2 °C
                24.70 °C  24.68 °C  24.65 °C
                NOMEAS NOMEAS  NOMEAS
                26.8 °C

2001/07/23  11:02:32  57.9%RH  25.6 °C
                24.45 °C  24.09 °C  24.65 °C
                NOMEAS NOMEAS  NOMEAS
                26.9 °C
  
```

**Note:** the *Logging* operation may be started at the same time as the *Record* function (key <6/RCD>) or as the *SerialOut* function (key <4/SERIALOUT>) and each operation does not influence the other. The letters flashing in the top right-hand corner of the display allow you to recognise which functions are simultaneously active at any given time. The table “INSTRUMENT SIGNALS AND MALFUNCTIONS” on p.80 gives the essential information for recognising the individual functions, how to conclude them and the references to the pages where these functions are explained in detail.

*Some of the commands described above contemplate the connection of the instrument to a personal computer; for these commands, see the next paragraph which explains step by step how to connect the instrument and set up the respective software.*

## INSTRUCTIONS FOR CONNECTING THE DO9847 TO A PC WITH WINDOWS OPERATING SYSTEM

This chapter details all necessary operations to download data from a DO9847 to a PC with Windows operating system installed, using the Hyper Terminal program (for example: how to connect the instrument to a PC, how to set transmission parameters both on PC and instrument, etc.).

**Those who are using DeltaLog3 software shall refer to the user's manual supplied with the software and not to the following instructions.**

### HARDWARE CONNECTION

1. The measuring instrument must be switched off.
2. Connect the port RS232C of the measuring instrument to the free serial port on the PC (COM1/COM2) using the Delta Ohm 9CPRS232 cable.
3. Switch the instrument on and set the baudrate at 115200 [key <Menu> >> function *Serial* >> sub-function *Baudrate* >> 7) to select 115200 >> key <ESC/CLR> (3 times)]

### SOFTWARE CONNECTION WITH WINDOWS 95, 98, NT, ME, 2000 AND XP

- A) After starting WINDOWS, select START, PROGRAMS, ACCESSORIES, HyperTerminal.  
Run HYPERTRM.EXE (double click).

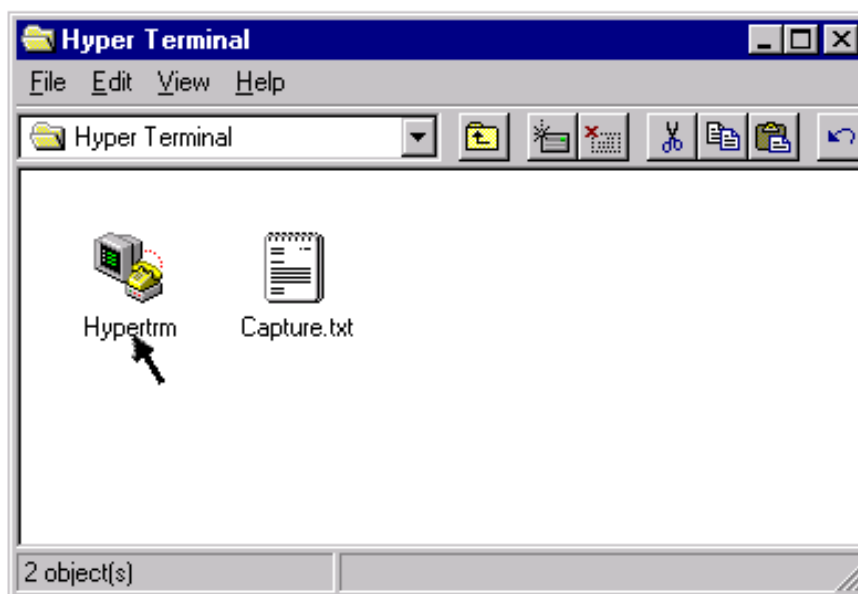

B) Name of the communication:

- In the window "Description of connection", give a name to the communication that you want to activate and choose an icon (in subsequent communications it will be possible to activate directly the icon chosen in place of HYPERTRM.EXE, automatically recovering all the settings saved with the icon).
- OK to confirm.
- Cancel in the next window.

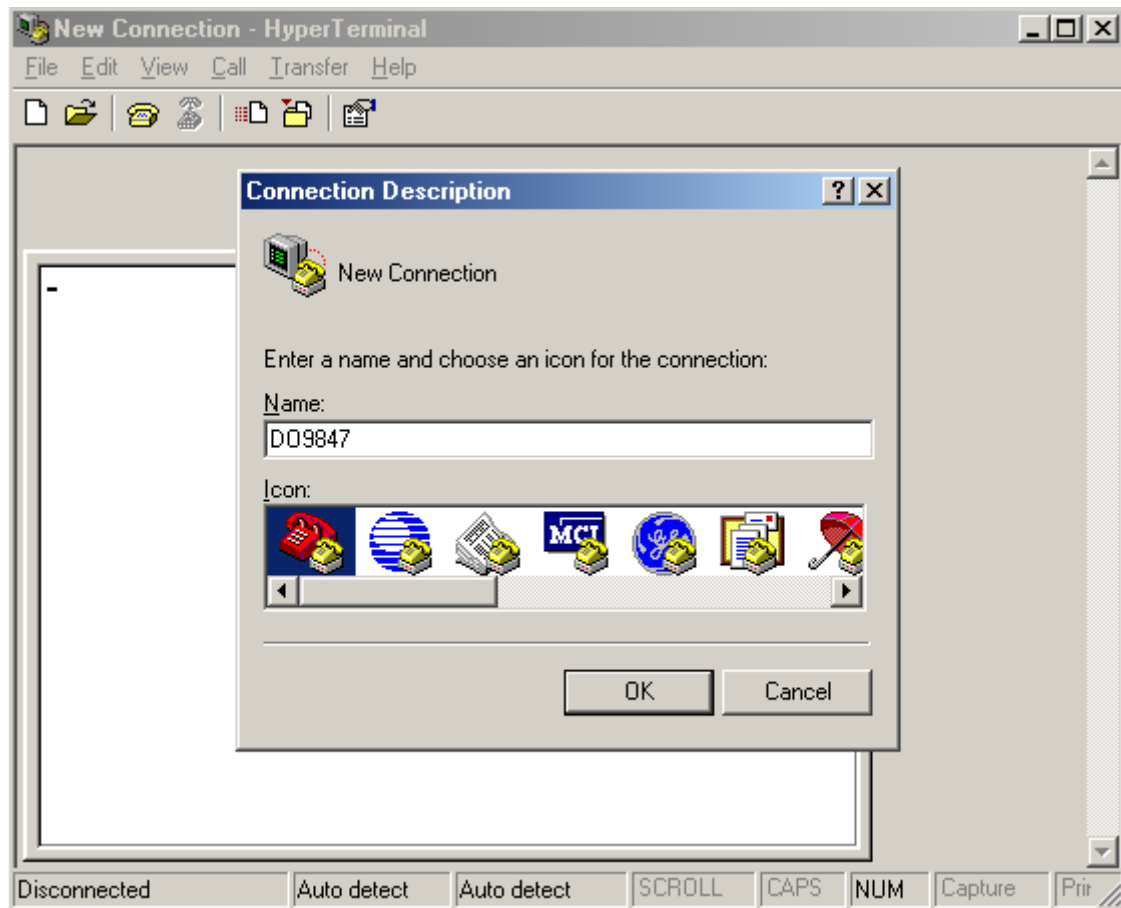

C) Setting communication:

- select FILE from the Hyper Terminal window (one click).
- select PROPERTIES from the pull-down menu (one click) and the "Properties" window will appear
- on the "telephone number" card, for the Connect property, choose "directly to COM1" or COM2, depending on the serial port that you intend to use for communication with the measuring instrument.

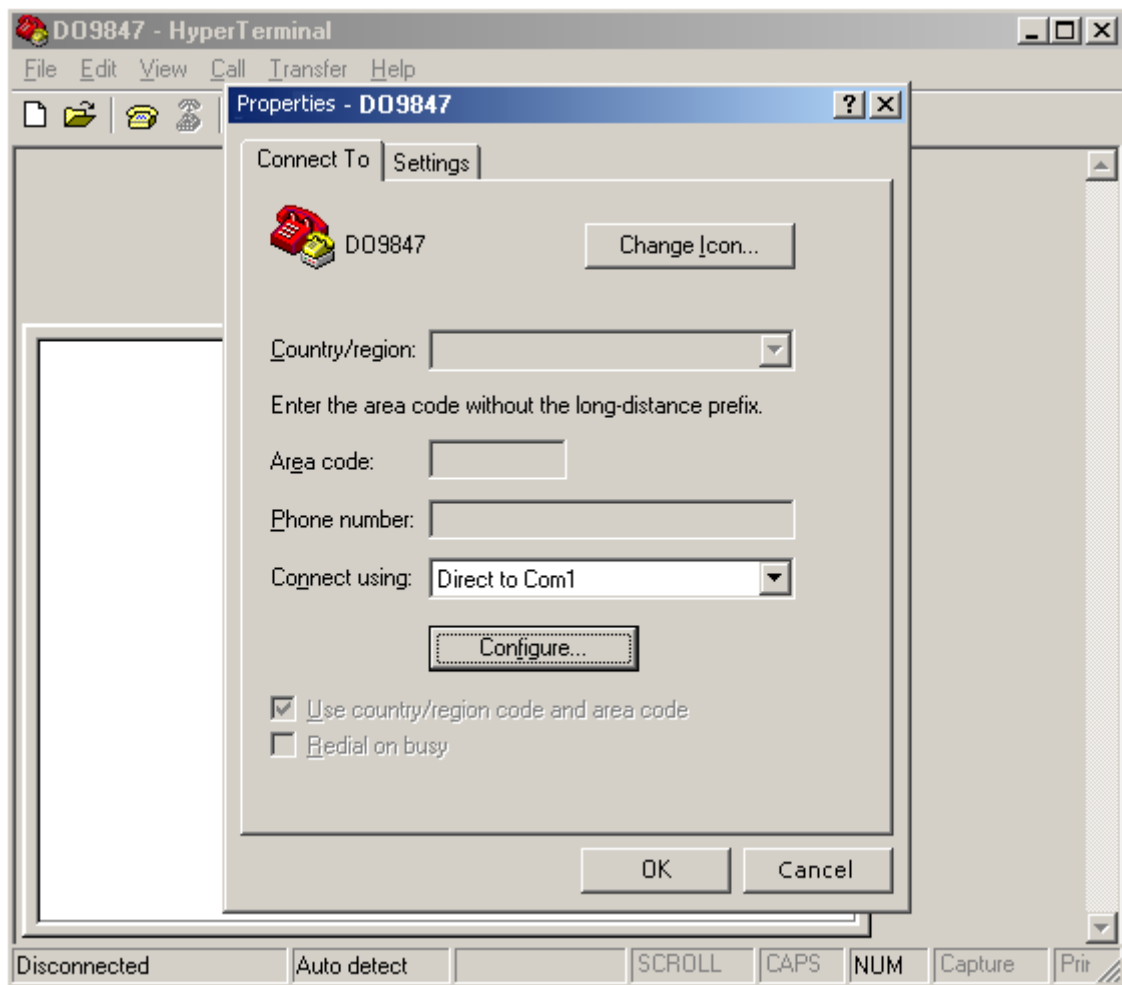



- on the "telephone number" card, select CONFIGURE (one click) and the "Port settings" card will appear
- on the "Port settings" card select:
  - BITS PER SECOND: 115200, (*See note below*)
  - DATA BITS: 8,
  - PARITY: None,
  - STOP BITS: 1,
  - FLOW CONTROL: Xon / Xoff,
  - OK to confirm the port setting (one click).

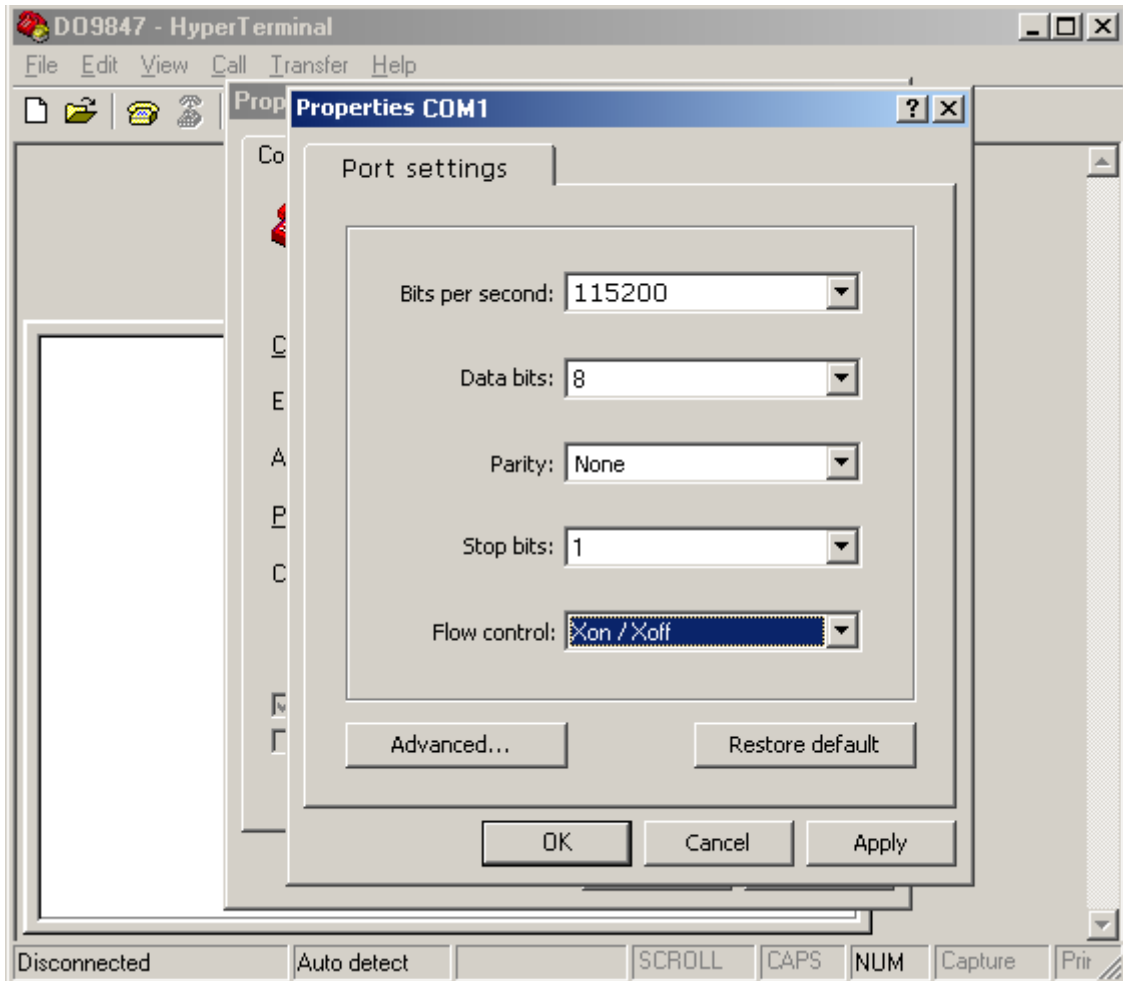

**Attention:** for the communication between DO9847 and computer to work, **the item TRANSMISSION VELOCITY on Terminal and Baud rate of the instrument must be set at the same value**; moreover, to transfer data at maximum velocity, it is recommended to use the highest possible value of baud rate (115200 baud). Only if the connecting cable between the instrument and the PC is longer than a few meters and some problems during the downloading occur, then the decrease of the baud rate value is suggested.  
 To set the Baud rate on the instrument see "4-0) Baud Rate" on p.22.

Still in the Properties window:

- select SETTINGS to display the "Settings" card
- on the "Settings" card, for the "Emulation" property, select: TTY.
- set the property "Buffer for back scroll" at 500
- OK to confirm the "Properties" set (one click).

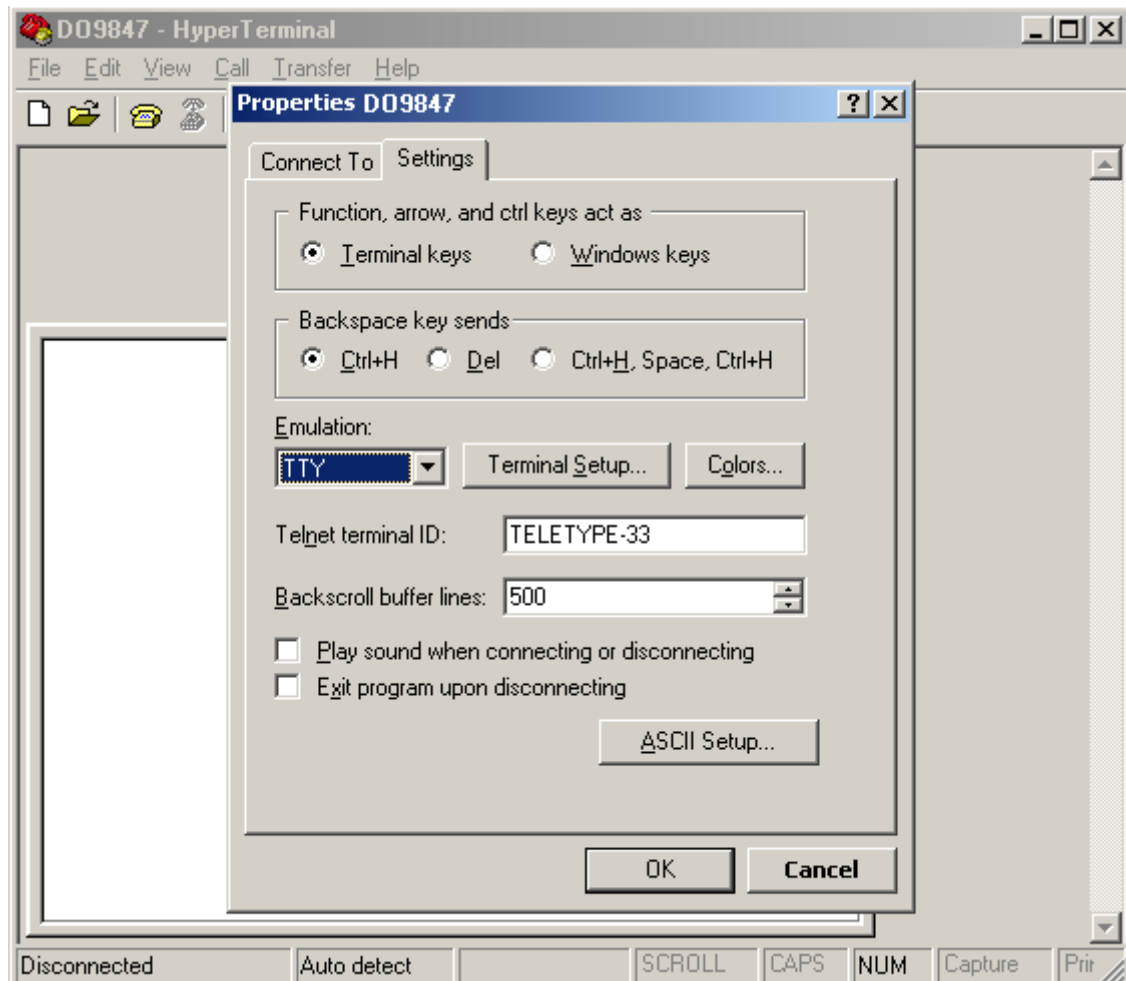

D) To set the correct character type:

- select DISPLAY from the Hyper Terminal window (one click).
- select CHARACTER from the pull-down menu (one click) and the window for selecting the character will appear; set: **Terminal**.
- As Style select: **Normal**
- Set Dimension at **9** or **11**
- OK to confirm (one click).

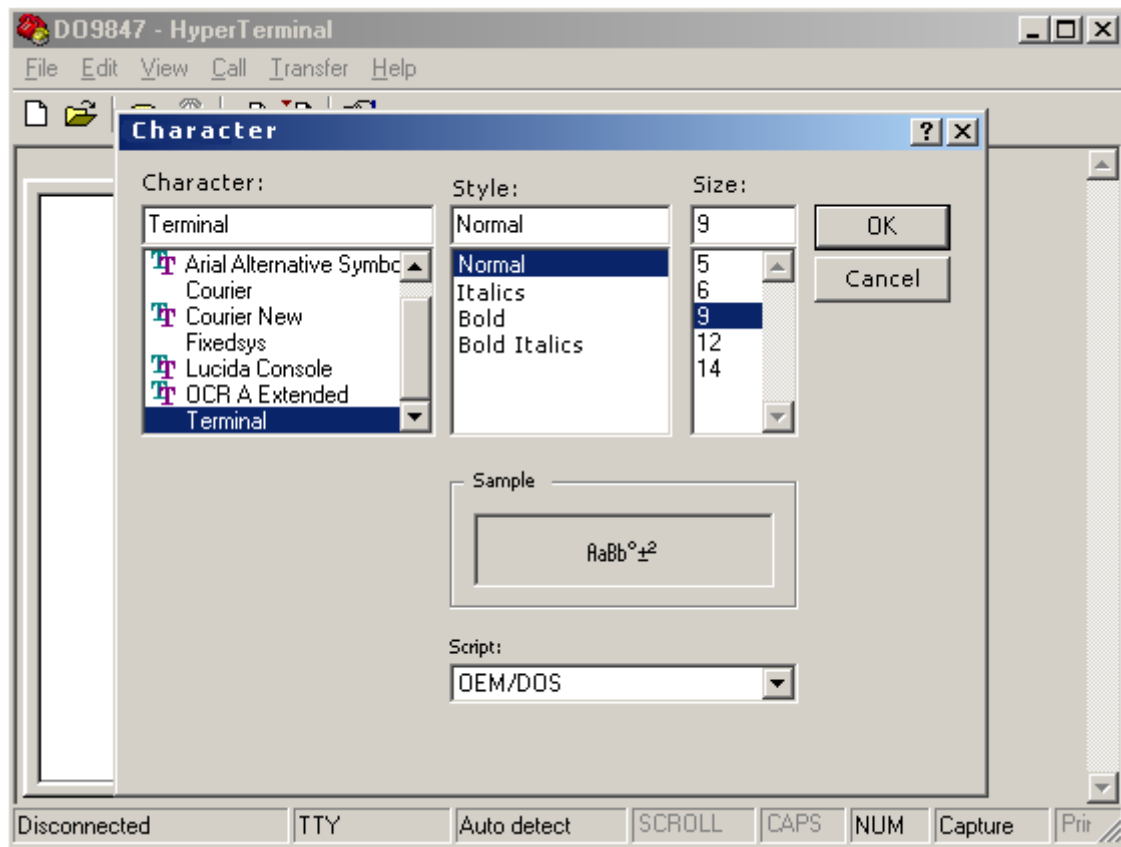

E) To receive data from an instrument:

- select CALL from the Hyper Terminal window (one click).
- select CONNECT (or CALL, according to Windows operating systems) from the pull-down menu.

In this way it is possible to receive the characters from the instrument on the monitor.

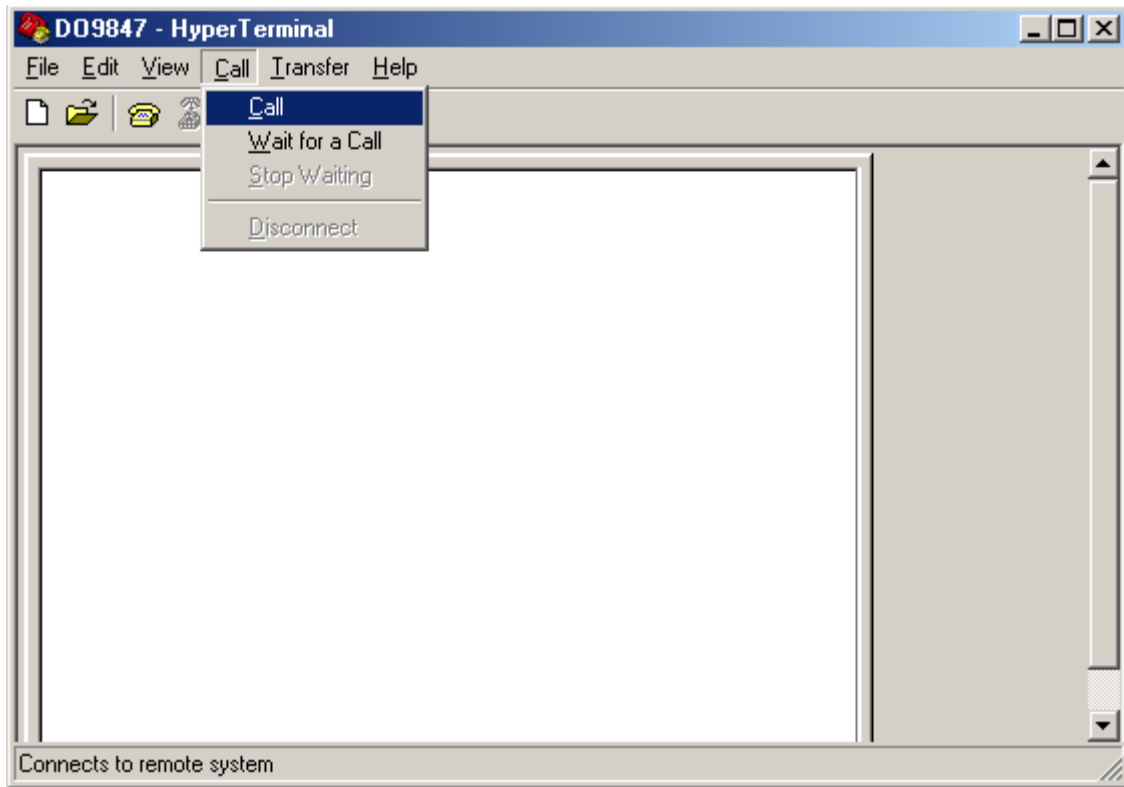

F) To store data received from an instrument:

- select TRANSFER from the Hyper Terminal window (one click).
- select CAPTURE TEXT from the menu (one click) and the window will appear where you have to set the name of the file in which to store the data received from instrument.
- type the name of the file in which the received data are to be stored on the line provided.
- START to set the name of the receiving file (one click).

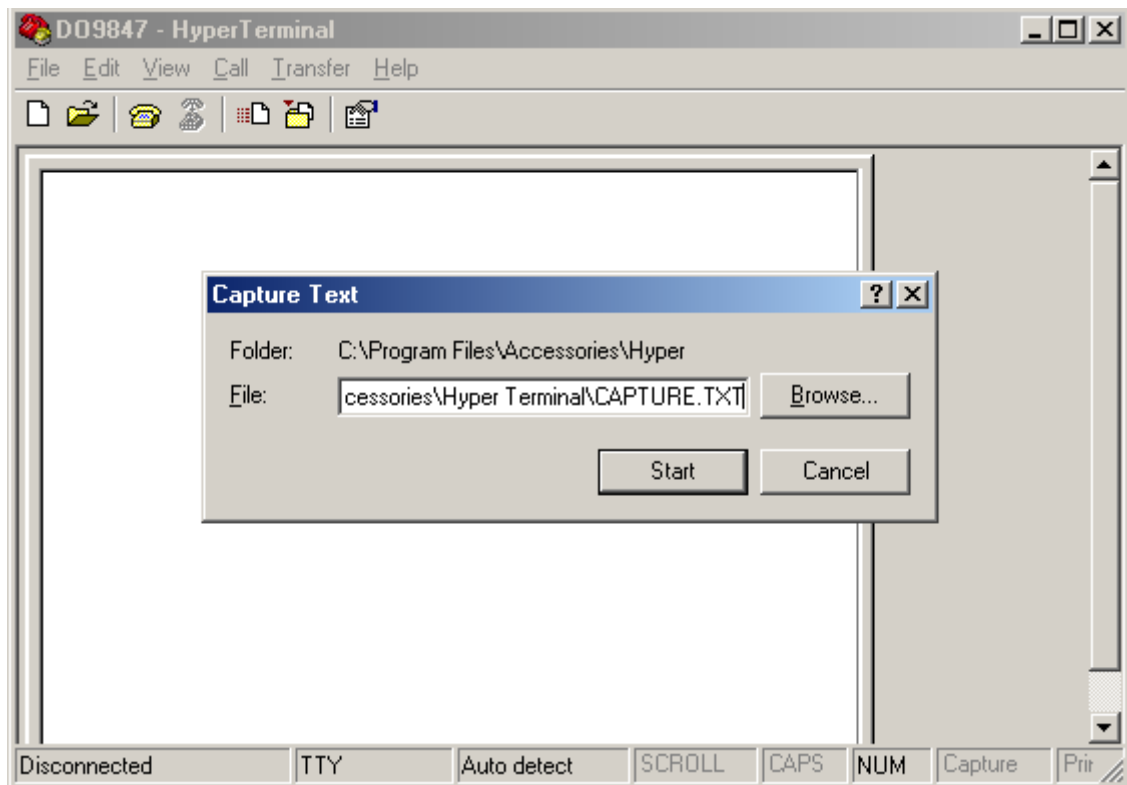

At this point the Hyper Terminal software is able to receive data from the measuring instrument and store them in the set file.

G) Switch on the measuring instrument.

When the instrument has completed the switching-on routine press the key <4/SERIALOUT>, activate the **immediate** unloading of the data (at the set rate) with one of the three sub-functions *Screen* key <F1> (see p.90), *RCD+* key <F2> (see p.91) or *ALL* key <F3> (see p.92). To activate the unloading of the data stored in the internal memory use the Menu sub-function “Print selected log” (*MENU* >> 2) *Logging* >> 4) *Log file manager* >> 0) *Print selected log* ) (see p.20).

H) To end receiving data from an instrument:

- select TRANSFER from the Hyper Terminal window (one click).
- select CAPTURE TEXT from the menu (one click).
- select END from the pull-down sub-menu (one click).

At this point data reception from the instrument is ended and the file stored in the computer can be used with any of the software packages used with WINDOWS.

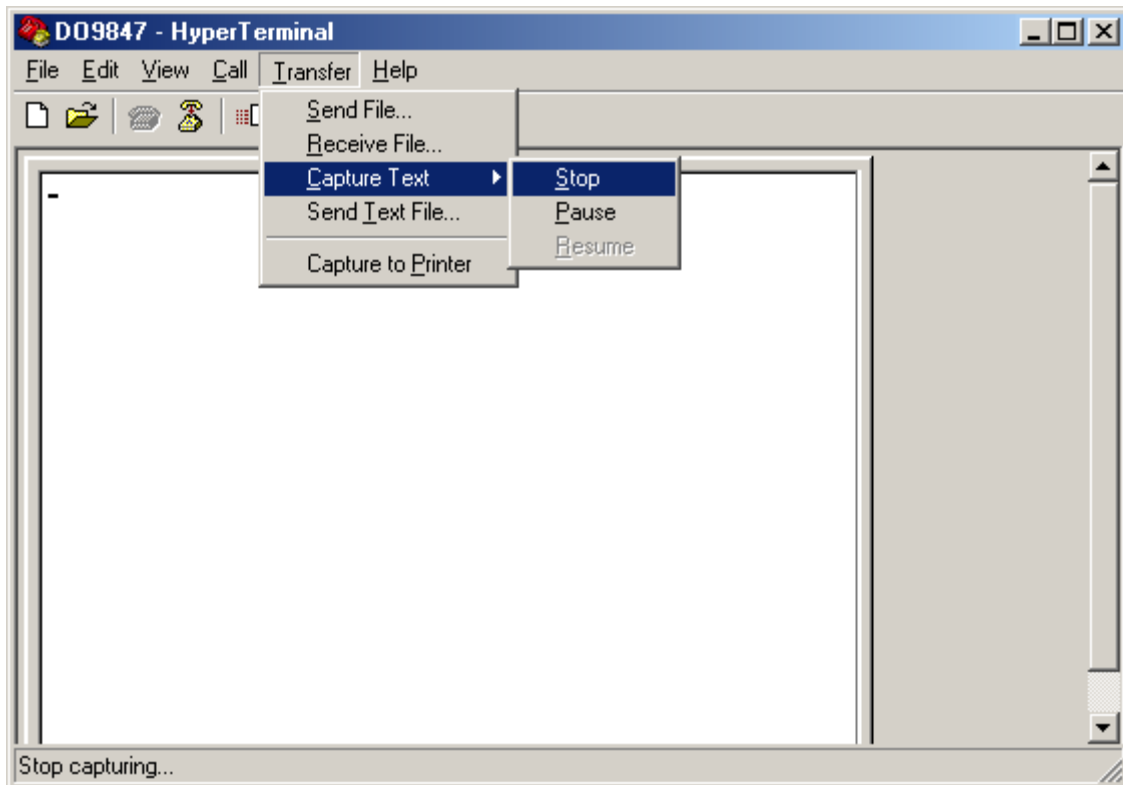

I) To quit running the Hyper Terminal:

- select FILE from the Hyper Terminal window (one click).
- select QUIT from the pull-down menu (one click).
- YES (one click) if you want to save the settings of the communication made.

## TECHNICAL DATA OF THE DO9847 MULTIFUNCTION INSTRUMENT

### *Housing*

Dimensions (Length x Width x Height)	245x100x50mm
Weight	300g (complete with batteries)
Materials	ABS, rubber
Display	graphic 56x38mm (128x64 pixel)

### *EMC Standards*

Degree of protection	IP64
Safety	EN61000-4-2, EN61010-1 level 3
Electrostatic discharges	EN61000-4-2 level 3
Fast electric transients	EN61000-4-4 level 3, EN61000-4-5 level 3
Voltage variations	EN61000-4-11
Susceptibility to electromagnetic interference	IEC1000-4-3
Emission of electromagnetic interference	EN55020 class B

### *Operating Conditions*

Working temperature	-10 ... 60°C
Storage temperature	-25 ... 65°C
Working relative humidity	0 ... 90% R.H. without condensation

### *Power Supply*

Batteries	4 batteries 1.5V type AA
Autonomy (with three Pt100 probes connected)	80 hours with alkaline batteries 1800mAh
Absorbed current with instrument switched off	50µA
Mains	Mains adapter output 9Vdc / 250mA

### *Safety of Logged Data*

Unlimited, irrespective of the state of charge of the batteries

### *Time*

Date and time	timing in real time
Precision	1min/month max deviation

### *Logging of the Measured Values*

With storing of 3 variables:	
Type	in 16 data files subdivided in pages of 16 samples each
Quantity	total 32000 samples
With storing of 10 variables:	
Type	in 16 data files subdivided in pages of 5 samples each
Quantity	total 10000 samples
Logging interval	1s ... 3600s (1 hour)

### *Serial Interface*

Type	RS232C galvanically insulated
Baud rate	settable from 300 to 115200 baud
Data bits	8
Parity	None

Stop bits	1
Flow control	Xon/Xoff
Cable length	Max 15m
Immediate printing interval	1s ... 3600s (1 hour) 5s ... 3600s (1 hour) with baud rate = 300

#### Connections

Module input for probes	DIN45326 8-pole connector
Serial interface	DB9 connector (male 9- pole)
Mains adapter	2-pole connector (positive in the middle)

#### Firmware

Updatable through the serial port of the instrument using DeltaLog3 software (starting up from instrument version 2.0)

### TECHNICAL DATA OF THE MODULES COMBINED WITH THE INSTRUMENT

#### Temperature measurement with a PRT Platinum sensor (TP471 Module)

Resistance values of the PRT @ 0°C	25Ω, 100Ω, 500Ω
Measuring range Pt25, Pt100	-200°C ... +850°C
Measuring range Pt500	-200°C ... +500°C
Accuracy with Pt25, Pt100 sensor	±0.03°C up to 350°C ±0.3°C up to 850°C
Accuracy with Pt500 sensor	±0.5°C up to 500°C
Resolution	0.01°C from -200°C to 350°C 0.1°C from 350°C to 800°C
Temperature drift @20°C	0.002%/°C
Energising current	400μA impulsive Duration=100ms, Period=1s

#### Temperature measurement with a thermocouple (TP471D0, TP471D, TP471D1 Modules)

Measuring range	
Thermocouple K	-200°C ... 1370°C
Thermocouple J	-100°C ... 750°C
Thermocouple T	-200°C ... 400°C
Thermocouple E	-200°C ... 750°C
Thermocouple R	+200°C ... 1480°C
Thermocouple S	+200°C ... 1480°C
Thermocouple B	+200°C ... 1800°C
Thermocouple N	-200°C ... 1300°C
Resolution	
Thermocouples K, J, T, E, N	0.05°C from start of scale to 350°C 0.1°C from 350°C to full scale.
Thermocouples R, S, B	0.1°C on the whole scale
Accuracy	
Thermocouple K	±0.1°C up to 600°C ±0.2°C beyond 600°C



Thermocouple J	±0.05°C up to 400°C ±0.1°C beyond 400°C
Thermocouple T	±0.1°C
Thermocouple E	±0.05°C up to 300°C ±0.08°C beyond 300°C
Thermocouple R	±0.25°C
Thermocouple S	±0.3°C
Thermocouple B	±0.35°C
Thermocouple N	±0.1°C up to 600°C ±0.2°C beyond 600°C

**Accuracy refers to the instrument combined to the module; it does not include the error due to the thermocouple and to the reference sensor of the cold junction.**

Temperature drift @20°C 0.02%/°C

*Measuring relative humidity and temperature (HP472AC, HP572AC, HP473AC, HP474AC, HP475AC, HP475AC1, HP477DC, HP478AC modules)*

*Measuring relative humidity*

Sensor	Capacitive
Typical working temperature of the probe	-40°C...+150°C
Measuring range	0 ... 100%R.H.
Accuracy	±1%RH in the range 20...90%RH ±2%RH in the range 10...99%RH
Resolution	0.1%RH
Temperature drift @20°C	0.02%RH/°C
Response time %RH at constant temperature	10sec (10→80%RH; air velocity=2m/s)

*Measuring temperature in the combined RH/°C probe*

Temperature sensor	Pt100 (100Ω @ 0°C)
Measuring range	-50°C...+200°C.
Accuracy	±0.03°C
Resolution	0.01°C
Temperature drift @20°C	0.003%/°C

Temperature sensor	Thermocouple K
Measuring range	-50°C...+200°C.
Accuracy	±0.5°C
Resolution	0.05°C
Temperature drift @20°C	0.02%/°C

*Measuring global solar radiation (module VP472)*

Measuring range	-25mV ... +25mV	
Resolution	1 W/m <sup>2</sup>	1μV
Accuracy	±1W/m <sup>2</sup>	±3μV
Sensitivity settable in the range	5 ... 30μV/(Wm <sup>-2</sup> )	

*Measuring pressure (module PP471)*

All the Delta Ohm TP704 and TP705 series pressure probes can be connected. See the table below for the technical specifications related to the probes.

*Technical data of the module*

Accuracy	±0.05% of full scale
Peak time	≥ 5ms
Peak accuracy	±0.5% full scale
Peak dead band	≤ 2% full scale

Full Scale Pressure	Maximum Overpressure	DIFFERENTIAL Pressure	RELATIVE Pressure (with respect to atmospheric pressure)	ABSOLUTE Pressure	ACCURACY From 20 to 25°C	Working Temperature	Connection
		NON-Isolated Diaphragm	Isolated Diaphragm	Isolated Diaphragm			
10.0 mbar	20.0 mbar	TP705-10MBD			0.50 % FSO	0...60°C	Tube Ø 5mm
20.0 mbar	40.0 mbar	TP705-20MBD			0.50 % FSO	0...60°C	Tube Ø 5mm
50.0 mbar	100 mbar	TP705-50MBD			0.50 % FSO	0...60°C	Tube Ø 5mm
100 mbar	200 mbar	TP705-100MBD			0.25 % FSO	0...60°C	Tube Ø 5mm
200 mbar	400 mbar	TP705-200MBD			0.25 % FSO	0...60°C	Tube Ø 5mm
			TP704-200MBGI		0.25 % FSO	0...80°C	¼ BSP
500 mbar	1000 mbar	TP705-500MBD			0.25 % FSO	0...60°C	Tube Ø 5mm
			TP704-500MBGI		0.25 % FSO	0...80°C	¼ BSP
1.00 bar	2.00 bar	TP705-1BD			0.25 % FSO	0...60°C	Tube Ø 5mm
			TP704-1BGI		0.25 % FSO	0...80°C	¼ BSP
2.00 bar	4.00 bar	TP705-2BD			0.25 % FSO	0...60°C	Tube Ø 5mm
			TP704-2BGI	TP704-2BAI	0.40 % FSO	0...80°C	¼ BSP
5.00 bar	10.00 bar		TP704-5BGI	TP704-5BAI	0.40 % FSO	0...80°C	¼ BSP
10.0 bar	20.0 bar		TP704-10BGI	TP704-10BAI	0.40 % FSO	0...80°C	¼ BSP
20.0 bar	40.0 bar		TP704-20BGI	TP704-20BAI	0.40 % FSO	0...80°C	¼ BSP
50.0 bar	100.0 bar		TP704-50BGI	TP704-50BAI	0.40 % FSO	0...80°C	¼ BSP
100 bar	200 bar			TP704-100BAI	0.40 % FSO	0...80°C	¼ BSP
200 bar	400 bar			TP704-200BAI	0.40 % FSO	0...80°C	¼ BSP
500 bar	750 bar			TP704-500BAI	0.40 % FSO	0...80°C	¼ BSP

*Measuring barometric pressure (module PP472)*

Measuring range	600...1100mbar
Resolution	0.1mbar
Accuracy @ 20°C	±0.3mbar
Temperature range	-10...+60°C

*Measurement of Differential Pressure (PP473 S1,..., PP473 S8 Module)*

Measuring Range	10mbar (S1), 20mbar (S2), 50mbar (S3), 100mbar (S4), 200mbar (S5), 500mbar (S6), 1bar (S7), 2bar (S8)
Max. Overpressure	200mbar (S1, S2, S3), 300mbar (S4), 1bar (S5, S6), 3bar (S7) e 6bar (S8)
Accuracy @ 25°C	±0.5% f.s. (10, 20, 50mbar) ±0.25% f.s. (100mbar) ±0.12% f.s. (200, 500, 1000 e 2000mbar)
Temperature Range	-10 ... +60°C
Fluid in contact with diaphragm	non corrosive, dry air and gas
Connection	Ø 5mm tube

*Hot-wire, Fan or Pitot tube air velocity Measurement  
(AP471..., AP472... and AP473... modules)*

See technical specifications listed in the tables at the end of each chapter dedicated to a single probe.

AP471... Modules – Hot-wire air velocity measurement from page 50 (table on page 55).

AP472... Modules – Fan air velocity measurement from page 56 (table on page 60).

AP473... Modules – Pitot tube air velocity measurement from page 61 (table on page 64).

*Photometric and radiometric measurements (module LP471...)*

See technical specifications listed in the chapter dedicated to the light probes from pag.72.

## ORDER CODES

- DO9847K** The kit is composed of the multifunction instrument, 4 alkaline batteries 1.5V each, instructions manual and carrying case. Any modules, probes, softwares and connection cables for serial output must be ordered separately.
- 9CPRS232** sub D 9-pole female/female connecting cable for RS232C (null modem)

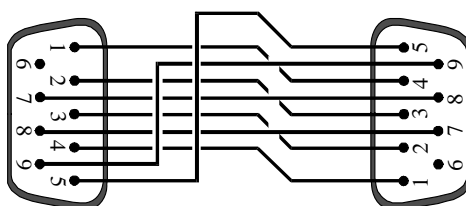

### *SICRAM Modules to Measure Temperature for DO9847 Multifunction Instrument*

- TP471** SICRAM electronic module for PRT sensors **without probe**. To the module, which has a 4-wire input, the user can connect temperature probes with a Platinum sensor: Pt 25  $\Omega$ , 100  $\Omega$  or 500  $\Omega$ . It is possible to calibrate the complete probe of the SICRAM module. If you know the Callendar – Van Dusen parameters of the probe, these can be inserted in the memory, thus obtaining a calibrated probe.
- TP471D0** SICRAM electronic module for thermocouple sensors, 1 input without compensation of the cold junction with 2-wire copper output cable, L=1.5m for connection with the thermocouple with cold junction at 0°C in ice. **Probes of the type K-J-E-T-N-R-S-B may be connected.** The calibration data remain in the memory. To be necessarily used when an uncertainty of joint temperature at 0°C not higher than 0.01°C is required.

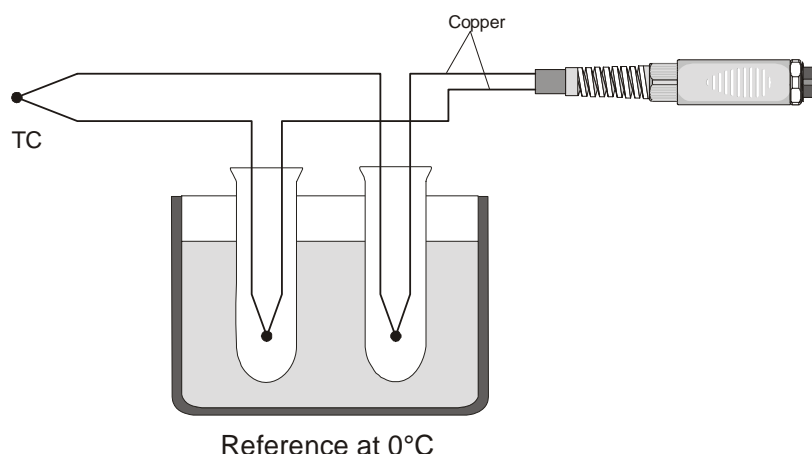

- TP471D** SICRAM electronic module for thermocouple sensors with MIGNON connector with 1 input. To the module, the user can connect 1 thermocouple probe type **K-J-E-T-N-R-S-B**; it is possible to calibrate the complete probe of the SICRAM module, the calibration data remain in the memory.

**TP471D1** SICRAM electronic module for thermocouple sensors type K-J-E-T-N-R-S-B with MIGNON connector with 2 inputs. To the module with two inputs, the user can connect 2 thermocouples **of the same type K-J-E-T-N-R-S-B**, even though of different shapes; it is possible to calibrate the complete probe of the SICRAM module, the calibration data remain in the memory.

*The type K probes available on the price list may be connected to the modules SICRAM TP471D, TP471D0 and TP471D1.*

***Probes with Pt100 sensor complete with SICRAM module for the multifunction instrument DO9847***

**TP472I** Immersion probe, Pt100 sensor with wire,  $\alpha$  385. Probe stem  $\varnothing$  3 mm, length 300 mm. 4-wire connecting cable, Length 2 metres complete with SICRAM module.  
Field of use:  $-196^{\circ}\text{C}\dots+500^{\circ}\text{C}$ .  
Accuracy:  $\pm 0.25^{\circ}\text{C}$  in the range  $-196^{\circ}\text{C}\dots+350^{\circ}\text{C}$   
 $\pm 0.40^{\circ}\text{C}$  in the range  $+350^{\circ}\text{C}\dots+500^{\circ}\text{C}$

**TP473P** Penetration probe, Pt100 sensor with wire,  $\alpha$  385.  
Probe stem  $\varnothing$  4 mm, Length 150 mm.  
4-wire connecting cable, length 2 metres complete with SICRAM module.  
Field of use:  $-100^{\circ}\text{C}\dots+400^{\circ}\text{C}$ .  
Accuracy:  $\pm 0.25^{\circ}\text{C}$  in the range  $-100^{\circ}\text{C}\dots+350^{\circ}\text{C}$   
 $\pm 0.40^{\circ}\text{C}$  in the range  $+350^{\circ}\text{C}\dots+400^{\circ}\text{C}$

**TP474C** Contact probe, sensor Pt100 with thin film,  $\alpha$  385. Stem  $\varnothing$  4 mm, length 230 mm, silver contact surface  $\varnothing$  5 mm. 4-wire cable, length 2 metres complete with SICRAM module.  
Field of use:  $-50^{\circ}\text{C}\dots+400^{\circ}\text{C}$   
Accuracy:  $\pm 0.25^{\circ}\text{C}$  in the range  $-50^{\circ}\text{C}\dots+350^{\circ}\text{C}$   
 $\pm 0.40^{\circ}\text{C}$  in the range  $+350^{\circ}\text{C}\dots+400^{\circ}\text{C}$

***Combined relative humidity and temperature probes complete with SICRAM module for the multifunction instrument DO9847***

**HP472AC** Combined RH% and temperature probe, dimensions  $\varnothing$  26 for 170 mm  
Connecting cable length: 2 metres.  
Field of use:  $-20^{\circ}\text{C}\dots+80^{\circ}\text{C}$ , 5...98% RH.  
Accuracy in RH%:  $\pm 2\%$   
Accuracy in  $^{\circ}\text{C}$ :  $\pm 0.30^{\circ}\text{C}$

**HP572AC** Combined RH% and K thermocouple temperature probe.  
Dimensions:  $\varnothing$  26x170 mm  
Connecting cable length: 2 meters.  
Field of use:  $-20^{\circ}\text{C}\dots+80^{\circ}\text{C}$ , 5...98% RH.  
Accuracy in RH%:  $\pm 2\%$   
Accuracy in  $^{\circ}\text{C}$ :  $\pm 0.5^{\circ}\text{C}$

- HP473AC** Combined RH% and temperature probe. Grip dimensions Ø 26x130 mm, probe Ø 14x120 mm.  
 Field of use: -20°C...80°C, 5...98% RH.  
 Accuracy in RH%: ±2%  
 Accuracy in °C: ±0.30°C
- HP474AC** Combined RH% and temperature probe. Grip dimensions Ø 26x130 mm, probe Ø 14x200 mm.  
 Field of use: -40°C...+150°C, 5...98% RH.  
 Accuracy in RH%: ±2.5%  
 Accuracy in °C: ±0.30°C
- HP475AC** Combined RH% and temperature probe. Grip Ø 26x110 mm. Stainless steel probe stem Ø12x500 mm. Tip Ø 13,5x75 mm.  
 Connecting cable length: 2 metres  
 Field of use: -40°C...+150°C, 5...98% RH.  
 Accuracy in RH%: ±2.5%  
 Accuracy in °C: ±0.35°C
- HP475AC1** Combined RH% and temperature probe. Stainless steel probe stem Ø14x500 mm with 20µm sintered stainless steel protection .Grip 80mm.  
 Connecting cable length: 2 metres  
 Field of use: -40°C...+180°C, 5...98% RH.  
 Accuracy in RH%: ±2.5%  
 Accuracy in °C: ±0.35°C
- HP477DC** Combined RH% and temperature probe. Connecting cable length: 2 metres, grip Ø 26x110 mm. Probe stem 18x4 mm, length: 500 mm  
 Field of use: -40°C...+150°C, 5...98% RH.  
 Accuracy in RH%: ±2.5%  
 Accuracy in °C: ±0.35°C
- HP478AC** Combined RH% and temperature probe. Stainless steel probe stem Ø14x130 mm with 20µm sintered stainless steel protection.  
 Connecting cable length: 5 metres  
 Field of use: -40°C...+150°C, 5...98% RH.  
 Accuracy in RH%: ±2.5%  
 Accuracy in °C: ±0.30°C

*Protection for RH probes HP472AC, HP572AC (M24x1,5)*

- P1** Stainless steel grid protection for probes Ø 26 mm.  
**P2** 20µ sintered polyethylene PE protection for probes Ø 26 mm.  
**P3** 20µ sintered bronze protection for probes Ø 26 mm.  
**P4** 20µ sintered PE complete cap for probes Ø 26 mm.

*Protection for RH probes HP473AC, HP474AC, HP475AC, HP475AC1 and HP478AC (M12x1)*

- P5** Stainless steel grid protection for probes Ø 14 mm.
- P6** 20µm sintered complete protection made of stainless steel for probes Ø 14 mm.
- P7** 10µm sintered complete protection made of PTFE for probes Ø 14 mm.
- P8** Stainless steel and Poca grid protection for probes Ø 14 mm.

***SICRAM module for solarimeters, albedometers for the DO9847 multifunction instrument***

- VP472** SICRAM electronic module for connecting solarimeters or albedometers to the datalogger DO9847. The values generated in time by a solarimeter or by an albedometer can be acquired, checked and stored. The signal generated by the thermopile of the solarimeter may be read in mV or in W/m<sup>2</sup>, the net radiation of the albedometer is read in W/m<sup>2</sup>. The sensitivity of the thermopile may be set from a minimum of 5000 to a maximum of 30000nV/(Wm<sup>-2</sup>) or between 5 and 30µV/(Wm<sup>-2</sup>).

***SICRAM modules for measurements of pressure for the DO9847 multifunction instrument***

- PP471** SICRAM electronic module for absolute, relative and differential pressure measurement. All the TP704 and TP705 series Delta Ohm pressure probes can be connected. It measures the instantaneous and peak pressure value. The module is complete with 2m cable and 8 pole DIN 45326 female connector.

***Probes Equipped with SICRAM Modules for Measurements of Pressure (to be Connected to DO9847 Multifunction Instrument)***

- PP472** Calibrated barometric probe equipped with SICRAM module for barometric pressure measurement in the range 600...1100mbar with resolution of 0.1mbar all over the measuring range. Avoid environments with corrosive gas and air. To be used in environments with dry gas and air only.
- PP473...** Probes equipped with SICRAM module for the measurement of differential pressure in the 10, ..., 2000mbar range. Operating temperature: -10...+60°C; ø5mm mounting tube. **Avoid environments with corrosive gas and air. To be used in environments with dry gas and air only.**

<b>PP473... Model Numbers</b>					
-------------------------------	--	--	--	--	--

Model N.	Full Scale	Model N.	Full Scale	Model N.	Full Scale
PP473 S1	10mbar	PP473 S2	20mbar	PP473 S3	50mbar
PP473 S4	100mbar	PP473 S5	200mbar	PP473 S6	500mbar
PP473 S7	1bar	PP473 S8	2bar		

***Probes Equipped with SICRAM Modules for Measurements of Air Velocity (to be Connected to DO9847 Multifunction Instrument)***

- AP471 S1** **Hotwire** probe provided with a SICRAM module to measure air velocity, calculated flow and temperature. Velocity from 0.05 to 40m/s, temperature compensation from 0 to 80°C, temperature from –30 to 110°C. 2m cable included.
- AP471 S2** **Omni-directional hotwire** probe provided with SICRAM module to measure air velocity, calculated flow and temperature. Velocity from 0.05 to 5m/s, temperature compensation from 0 to 80°C, temperature from –10 to 110°C. 2m cable included.
- AP471 S3** **Hotwire** probe equipped with SICRAM module to measure air velocity, calculated flow and temperature. Velocity from 0.05 to 40m/s, temperature compensation from 0 to 80°C, temperature from –30 to 110°C. 2m cable included. Articulated tip for easy positioning.
- AP471 S4** **Omni-directional hotwire** probe provided with Ø 120mm base and telescopic shaft to measure velocity, calculated flow and air temperature. Velocity from 0.05 to 5m/s temperature compensated from 0 to 80°C, temperature from 0 to 80°C. Probe equipped with SICRAM module and 2m cable.
- AP471 S5** **Omnidirectional hot-wire** telescopic probe to measure velocity, calculated flow and air temperature. Velocity from 0.05 to 5m/s temperature compensated from 0 to 80°C, temperature from 0 to 80°C. Probe equipped with SICRAM module and 2m cable.
- AP471 S6** **Omnidirectional hot-wire** telescopic probe to measure velocity, calculated flow and air temperature. Velocity from 0.05 to 5m/s temperature compensated from 0 to 80°C, temperature from 0 to 80°C. Probe equipped with SICRAM module and 2m cable
- AP472 S1** **Vane** probe equipped with SICRAM module to measure air velocity, calculated flow and temperature through a thermocouple sensor. Vane diameter: 100mm. Velocity from 0.6 to 30m/s; temperature from –25 to 80°C. Probe provided with handle; telescopic shaft on request. Minimum length with handle L=360mm, maximum length L=1025mm. 2m cable included.
- AP472 S2** **Vane** probe equipped with SICRAM module to measure air velocity and calculated flow. Vane diameter: 60mm. Velocity from 0.3 to 20m/s, operating temperature from -25 to 80°C. 2m cable included. Provided with handle and telescopic shaft.
- AP472 S4L** **Vane** probe equipped with SICRAM module to measure air velocity and calculated flow. Vane diameter: 16mm. Velocity from 0.8 to 20m/s. Probe is equipped with handle; telescopic shaft on request. Minimum length with handle L=360mm, maximum length L=1025mm. 2m cable.
- AP472 S4LT** **Vane** probe equipped with SICRAM module to measure air velocity, calculated flow and temperature. Vane diameter: 16mm. Velocity from 0.8 to 20m/s. Temperature from –30 to 120°C with K thermocouple sensor (\*). Probe is



equipped with handle; telescopic shaft on request. Minimum length with handle L=360mm, maximum length L=1025mm. 2m cable.

**AP472 S4H** **Vane probe** equipped with SICRAM module to measure air velocity and calculated flow. Vane diameter: 16mm. Velocity from 10 to 50m/s. Probe is equipped with handle; telescopic shaft on request. Minimum length with handle L=360mm, maximum length L=1025mm. 2m cable.

**AP472 S4HT** **Vane probe** equipped with SICRAM module to measure air velocity and calculated flow. Vane diameter: 16mm. Velocity from 10 to 50m/s. Temperature from -30 to 120°C with K thermocouple sensor (\*). Probe is equipped with handle; telescopic shaft on request. Minimum length with handle L=360mm, maximum length L=1025mm. 2m cable.

(\*) The temperature limit refers to the top of the probe where the vane and the temperature sensor are located and not to the handle, the cable and the telescopic shaft which maximum working temperature is 80°C.

**AP471S1.23.6** Fixed extension shaft Ø16x300mm, M10 male thread on a side, female on the other. For vane probes AP472S1, S2 and S4.

**AP471S1.23.7** Fixed extension shaft Ø16x300mm, M10 female thread on a side only. For vane probes AP472S1, S2 and S4.

**AST.1** Telescopic shaft (minimum length 210 mm, maximum length 870 mm)

**AP473 S1** **Pitot tube probe** equipped with SICRAM module to measure air velocity, calculated flow and temperature through a thermocouple sensor. Differential pressure up to 10mbar. Velocity from 2 to 40m/s, temperature compensation. Avoid environments with corrosive gas and air. To be used in environments with dry gas and air only.

**AP473 S2** **Pitot tube probe** equipped with SICRAM module to measure air velocity, calculated flow and temperature through a thermocouple sensor. Differential pressure up to 20mbar. Velocity from 2 to 55m/s, temperature compensation. Avoid environments with corrosive gas and air To be used in environments with dry gas and air only.

**AP473 S3** **Pitot tube probe** equipped with SICRAM module to measure air velocity, calculated flow and temperature through a thermocouple sensor. Differential pressure up to 50mbar. Velocity from 2 to 90m/s, temperature compensation. Avoid environments with corrosive gas and air To be used in environments with dry gas and air only.

**AP473 S4** **Pitot tube probe** equipped with SICRAM module to measure air velocity, calculated flow and temperature through a thermocouple sensor. Differential pressure up to 100mbar. Velocity from 2 to 130m/s, temperature compensation. Avoid environments with corrosive gas and air To be used in environments with dry gas and air only.

**PW** Extension with male-female standard miniature connectors to connect the Pitot tube's thermocouple K to the instrument, length 2m.

**AP473 S... modules can be accompanied by T1-..., T2-..., T3-... and T4-... Pitot tubes (see page 63)**

***SICRAM modules for measurements of continuous voltage and continuous current for the DO9847 multifunction instrument***

**VP473** SICRAM electronic module for reading continuous voltages. Connected to the output of transmitter with a voltage signal, it can read and acquire the value.  
Measuring range:  $\pm 20\text{Vdc}$   
Input impedance:  $1\text{M}\Omega$

**IP472** SICRAM electronic module for reading continuous currents in mA. Connected to the output of transmitter with a current signal, it can read and acquire the value.  
Measuring range:  $0 \dots 24\text{mA}$   
Input impedance:  $25\Omega$ .

***Probes Equipped with SICRAM Modules for Measurements of Light (to be connected to DO9847 Multifunction Instrument)***

**LP 471PHOT** Photometric probe for measuring **ILLUMINANCE**, equipped with SICRAM module, spectral response following standard photopic vision, diffuser for cosine correction. Operating Range:  $0.01 \text{ lux} \dots 200 \cdot 10^3 \text{ lux}$ .

**LP 471 RAD** Radiometric probe for measuring **IRRADIANCE**, equipped with SICRAM module with spectral response range from 400 nm to 1050 nm, diffuser for cosine correction. Operating Range:  $0.1 \cdot 10^{-3} \text{ W/m}^2 \dots 2000 \text{ W/m}^2$ .

**LP 471 PAR** Quantum-radiometric probe for measuring chlorophyll photon flow (**PAR**: Photosynthetically Active Radiation 400 nm...700 nm), equipped with SICRAM module, measuring in  $\mu\text{mol/m}^2\text{s}$ , diffuser for cosine correction.  
Measuring range:  $0.01 \mu\text{mol/m}^2\text{s} \dots 10 \cdot 10^3 \mu\text{mol/m}^2\text{s}$

**LP 471 UVA** Radiometric probe for measuring **IRRADIANCE**, equipped with SICRAM module having 315 nm...400 nm **UVA** spectral range, peak at 360 nm, quartz diffuser for cosine correction. Measuring Range:  $0.1 \cdot 10^{-3} \text{ W/m}^2 \dots 2000 \text{ W/m}^2$ .

**LP 471 UVB** Radiometric probe for measuring **IRRADIANCE**, equipped with SICRAM module having 280 nm...315 nm **UVB** spectral response range, peak at 305 nm, quartz diffuser for cosine response. Measuring range:  $0.1 \cdot 10^{-3} \text{ W/m}^2 \dots 2000 \text{ W/m}^2$ .

**LP 471 UVC** Radiometric probe for measuring **IRRADIANCE**, equipped with SICRAM module having 220 nm...280 nm **UVC** spectral response range, peak at

260 nm, quartz diffuser for cosine correction. Measuring range:  
 $0.1 \cdot 10^{-3} \text{ W/m}^2 \dots 2000 \text{ W/m}^2$ .

**LP 471 LUM 2** Photometric probe for measuring **LUMINANCE**, equipped with SICRAM module, spectral response following standard photopic vision, field of view  $2^\circ$ . Measuring range:  $0.1 \text{ cd/m}^2 \dots 2000 \cdot 10^3 \text{ cd/m}^2$ .

## APPENDIX

### Pt100 SENSOR

The temperature response of the sensor used in the family of platinum probes (type Pt100) is described by means of the Callendar Van Dusen formula (1).

$$(1) \quad \begin{aligned} R(t) &= R_0 \cdot (1 + At + Bt^2 + Ct^3(t-100)) & t < 0^\circ\text{C} \\ R(t) &= R_0 \cdot (1 + At + Bt^2) & t \geq 0^\circ\text{C} \end{aligned}$$

The coefficient C is considered equal to 0 for temperatures above zero.

To find the value of the coefficients of equation (1) it is necessary to calibrate the probe on at least three different points: once they are known, these coefficients are inserted in the regression formula (2) to determine the temperature with relation to the resistance value of the sensor.

$$(2) \quad t_{n+1} = \frac{\frac{R(t_n) - 1}{R_0}}{A + Bt_n + Ct_n^2(t_n - 100)} \quad t_n < 0^\circ\text{C}$$

$$t_{n+1} = \frac{\frac{R(t_n) - 1}{R_0}}{A + Bt_n} \quad t_n \geq 0^\circ\text{C}$$

The coefficients A, B and C for Standard Platinum probes are defined by the standard EN60751 em.2 as:

$$\begin{aligned} A &= 3.9083E-3^\circ\text{C}^{-1} \\ B &= -5.775E-7^\circ\text{C}^{-2} \\ C &= -4.183E-12 \cdot \text{C}^{-4} \end{aligned} \quad \text{with } R(0^\circ\text{C}) = 100\Omega$$

The same standard also defines the value  $\alpha$  as:

$$(3) \quad \alpha = \frac{R_{100} - R_0}{100 \cdot R_0} = 0.00385055^\circ\text{C}^{-1}$$

The relationship (1) between the sensor resistance and the temperature may be described alternatively by the following relationship:

$$(4) \quad R(t) = R_0 \cdot \left\{ 1 + \alpha \cdot \left[ t - \delta \frac{t}{100} \left( \frac{t}{100} - 1 \right) - \beta \left( \frac{t}{100} - 1 \right) \left( \frac{t}{100} \right)^3 \right] \right\} \quad t < 0^\circ\text{C}$$

$$R(t) = R_0 \cdot \left\{ 1 + \alpha \cdot \left[ t - \delta \frac{t}{100} \left( \frac{t}{100} - 1 \right) \right] \right\} \quad t \geq 0^\circ\text{C}$$

for which the following relationships apply:

$$\alpha = A + 100B = 0.00385055 \cdot C^{-1}$$

$$(5) \quad \delta = -\frac{100}{\frac{A}{100B} + 1} = 1.499785$$

$$\beta = -\frac{10^8 C}{A + 100B} = 0.10863$$

In (5),  $\alpha$  coincides with the one defined in standard EN60751: it can be determined with a calibration operation on only two points.

Given the sensor resistance, the temperature is obtained with the regression formula (6):

$$(6) \quad t_{n+1} = \frac{\frac{R}{R_0} - 1}{\alpha \left[ 1 + \frac{\delta}{100} - \frac{\delta t_n}{10000} - \beta \left( \frac{t_n}{100} - 1 \right) \left( \frac{t_n}{100} \right)^2 \left( \frac{1}{100} \right) \right]} \quad t_n < 0^\circ\text{C}$$

$$t_{n+1} = \frac{\frac{R}{R_0} - 1}{\alpha \left[ 1 + \frac{\delta}{100} - \frac{\delta t_n}{10000} \right]} \quad t_n \geq 0^\circ\text{C}$$

Note that, unlike (2) which uses the coefficients A, B and C, equation (6) is calculated in such a way to point out the factor  $\alpha$ .

This means that, when the value  $\alpha$  calculated as in (5) and the **nominal** values of  $\delta$  and  $\beta$ , are inserted in (6), a precision of around  $0.05^\circ\text{C}$  is obtained.

Taking it from the first of the (4), it is possible to obtain a generalisation of the coefficient  $\alpha$  calculated between  $0^\circ\text{C}$  and a temperature higher than  $100^\circ\text{C}$ :

$$(7) \quad \alpha = \frac{(R(t) - R_0)}{R_0 \cdot \left[ t - \delta \frac{t}{100} \cdot \left( \frac{t}{100} - 1 \right) \right]} \quad \delta = \delta_{nominal}$$

This allows to make the calibration at  $0^\circ\text{C}$  and at another selected point, provided that it is higher than  $100^\circ\text{C}$ .

# SUMMARY

<b>INTRODUCTION .....</b>	<b>4</b>
<b>KEYBOARD DESCRIPTION.....</b>	<b>5</b>
Use of the <Hold> key.....	12
Use of the <REL> key .....	13
Xsel, Ysel and Zsel commands.....	14
<b>DESCRIPTION OF THE MENU FUNCTIONS.....</b>	<b>15</b>
0) Info (Information).....	15
1) Config (Configurations) .....	15
1-1) Reserved Function Lock .....	15
1-2) Change password .....	16
1-3) Probe options .....	16
2) Logging .....	17
2-0) Log Interval.....	17
2-1) Self shut-off mode.....	18
2-2) Start/stop time .....	18
2-3) Cancel auto start.....	19
2-4) Log File Manager.....	20
2-4-0) Print Selected Log.....	20
2-4-1) View Selected Log.....	21
2-4-2) Erase Selected Log.....	21
2-4-3) Erase ALL logs.....	21
3) Time/date.....	22
4) Serial (Digital Communication) .....	22
4-0) Baud Rate.....	22
4-1) Print Interval .....	22
5) Calibrate .....	23
6) Reset.....	23
7) Utility (Instruments).....	24
7-1) Area Calculations.....	24
8) Options .....	26
8-1) Comp. Temp. Select (Selection of Compensating Temperature).....	26
8-2) Flow Averaging Time .....	26
8-3) Comp. Atm. pressure (Atmospheric Pressure Compensation).....	27
<b>THE PROBES.....</b>	<b>28</b>
Pt100 temperature probes .....	28
Calibration of Pt100 Probes.....	29
<i>Electronic module TP471 SICRAM for PRT sensors without probe.</i> .....	31
Thermocouple temperature probes .....	32
<i>Calibration of Thermocouple Probes</i> .....	32
Relative humidity probes.....	35
Calibration of the Combined Humidity/Temperature Probe.....	36
Calibration of the Pt100 or thermocouple Temperature Sensor.....	37
Calibration of the Relative Humidity Sensor.....	37
Humidity and Quality Indices (Comfort Indices).....	41

Discomfort Index (DI) .....	42
Net Index NI .....	42
PP471 electronic module for pressure measurement .....	43
Relative measure.....	44
PP472 Electronic Module for Barometric Pressure Measurement.....	45
PP473 Electronic Module for the Measurement of Differential Pressure.....	46
AP471..., AP472... and AP473... Probes for the measurement of Air velocity equipped with SICRAM Module.....	47
Note Concerning DO9847 Version.....	48
Flow Measurement .....	48
Operating .....	48
AP471 S1, AP471 S2, AP471 S3 , AP471 S4, AP471S5 and AP471S6 Hot Wire Probes for measurement of air velocity equipped with SICRAM module .....	50
Zero Command.....	50
Operation .....	51
Probe Care and Maintenance .....	52
Dimensions .....	53
Technical Specifications.....	55
AP472 S1, AP472 S2 and AP472 S4 Vane probes for air velocity measurement equipped with SICRAM module .....	56
Calibrations.....	56
Operation .....	56
Probe Care and Maintenance .....	57
Dimensions .....	58
Technical Specifications.....	60
AP473 S1 ... AP473 S4 Pitot Tube Probes for the Measurement of air velocity equipped with SICRAM module .....	61
<i>Measuring Principle</i> .....	61
<i>AP473 S1 ... AP473 S4 modules</i> .....	62
<i>Operation</i> .....	62
<i>Dimensions of Pitot Tubes</i> .....	63
<i>Technical Specifications</i> .....	64
VP472 electronic module for solarimeters and albedometers.....	65
<i>Inserting the sensitivity of the solarimeter or albedometer</i> .....	65
Electrical connection of the solarimeter or of the albedometer to the VP472 module.....	66
LP 471 PHOT, RAD, UVA, UVB, UVC, PAR and LUM2 Photometric and Radiometric Probes equipped with SICRAM Module .....	68
Q/TIME INTEGRATION .....	69
TECHNICAL SPECIFICATIONS OF PROBES EQUIPPED WITH SICRAM MODULE .....	72
Electronic modules VP473 and IP472 for measuring voltage and continuous current.....	78
<b>UPDATING FIRMWARE.....</b>	<b>79</b>
<b>METHOD OF USING THE INSTRUMENT AND WARNINGS.....</b>	<b>79</b>
<b>INSTRUMENT SIGNALS AND MALFUNCTIONS .....</b>	<b>80</b>
<b>LOW BATTERY WARNING AND BATTERY REPLACEMENT .....</b>	<b>82</b>
<b>STORAGE OF THE INSTRUMENT.....</b>	<b>83</b>
<b>SERIAL INTERFACE RS232C.....</b>	<b>84</b>
<b>THE FUNCTIONS OF STORING AND TRANSFERRING DATA TO A PERSONAL COMPUTER.....</b>	<b>86</b>

The <i>Record</i> function .....	86
The <i>Logging</i> function .....	88
The <i>Screen</i> function .....	90
The <i>RCD+</i> function .....	91
The <i>ALL</i> function .....	92
<b>INSTRUCTIONS FOR CONNECTING THE DO9847 TO A PC WITH WINDOWS OPERATING SYSTEM.....</b>	<b>94</b>
Hardware connection .....	94
Software connection with WINDOWS 95, 98, NT, ME, 2000 and Xp .....	94
<b>TECHNICAL DATA OF THE DO9847 MULTIFUNCTION INSTRUMENT.....</b>	<b>103</b>
Technical data of the modules combined with the instrument.....	104
<b>ORDER CODES .....</b>	<b>108</b>
<b>APPENDIX.....</b>	<b>116</b>
Pt100 SENSOR.....	116



# CERTIFICATO DI CONFORMITÀ DEL COSTRUTTORE

MANUFACTURER'S CERTIFICATE OF CONFORMITY

rilasciato da

*issued by*

**DELTA OHM SRL STRUMENTI DI MISURA**

**DATA**

2009/06/17

*DATE*

Si certifica che gli strumenti sotto riportati hanno superato positivamente tutti i test di produzione e sono conformi alle specifiche, valide alla data del test, riportate nella documentazione tecnica.

*We certify that below mentioned instruments have been tested and passed all production tests, confirming compliance with the manufacturer's published specification at the date of the test.*

La riferibilità delle misure ai campioni internazionali e nazionali delle unità del SIT è garantita da una catena di riferibilità ininterrotta che ha origine dalla taratura dei campioni di laboratorio presso l'Istituto Primario Nazionale di Ricerca Metrologica.

*The traceability of measures assigned to international and national reference samples of SIT units is guaranteed by a uninterrupted reference chain which source is the calibration of laboratories samples at the Primary National Metrological Research Institute.*

**Tipo Prodotto:**                    **Strumento multifunzione**

*Product Type:*                    *Multifunction Meter*

**Nome Prodotto:**                **DO9847**

*Product Name:*

**Responsabile Qualità**

*Head of Quality*

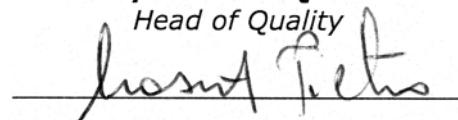

**DELTA OHM SRL**

**35030 Caselle di Selvazzano (PD) Italy**

**Via Marconi, 5**

Tel. +39.0498977150 r.a. - Telefax +39.049635596

Cod. Fisc./P.Iva IT03363960281 - N.Mecc. PD044279

R.E.A. 306030 - ISC. Reg. Soc. 68037/1998

# GUARANTEE



## GUARANTEE CONDITIONS

All DELTA OHM instruments have been subjected to strict tests and are guaranteed for 24 months from date of purchase. DELTA OHM will repair or replace free of charge any parts which it considers to be inefficient within the guarantee period. Complete replacement is excluded and no request of damages are recognized. The guarantee does not include accidental breakages due to transport, neglect, incorrect use, incorrect connection to voltage different from the contemplated for the instrument. Furthermore the guarantee is not valid if the instrument has been repaired or tampered by unauthorized third parties. The instrument has to be sent to the retailer without transport charge. For all disputes the competent court is the Court of Padua.



The electric and electronic devices with the following symbol cannot be disposed in the public dumps. According to the Directive UE 2002/96/EC, the European users of electric and electronic devices are allowed to give back to the Distributor or Manufacturer the used device at the time of purchasing a new one. The illegal disposing of electric and electronic devices is punished by a pecuniary administrative penalty.

This guarantee must be sent together with the instrument to our service centre.

N.B.: Guarantee is valid only if coupon has been correctly filled in all details.

**Instrument type**                       **DO9847**

Serial number \_\_\_\_\_

## RENEWALS

Date _____	Date _____
Inspector _____	Inspector _____
Date _____	Date _____
Inspector _____	Inspector _____
Date _____	Date _____
Inspector _____	Inspector _____



CE CONFORMITY	
Safety	EN61000-4-2, EN61010-1 LEVEL 3
Electrostatic discharge	EN61000-4-2 LEVEL 3
Electric fast transients	EN61000-4-4, EN61000-4-5 LEVEL 3
Voltage variations	EN61000-4-11
Electromagnetic interference susceptibility	IEC1000-4-3
Electromagnetic interference emission	EN55020 class B