



KERN & Sohn GmbH

Ziegelei 1
D-72336 Balingen
E-mail: info@kern-sohn.com
www.kern-sohn.com

Telefono: +49-[0]7433-9933-0
Fax: +49-[0]7433-9933-149
Internet: www.kern-sohn.com

Istruzioni per montaggio dello stativo

KERN EOB-A01B-A02B

Versione 1.1
12/2016

I

EOB-A01B-A02B-IA-i-1611

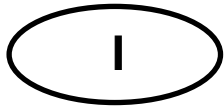

KERN EOB-A01B-A02B

Versione 1.1 12/2016

Istruzioni per montaggio dello stativo

Sommario

1	Caratteristiche tecniche	2
2	Componenti del pacco.....	3
3	Panoramica di modelli.....	5



EOB-A01B







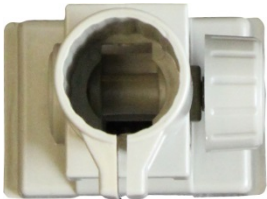

solo per piattaforme dalle dimensioni 304 x 315 mm

1 Caratteristiche tecniche







KERN	EOB-A01B	EOB-A02B
Altezza stativo	48 cm	100 cm

2 Componenti del pacco

EOB-A01B:

 <p>Stativo</p>	 <p>Portadisplay</p>
 <p>Piede stativo</p>	 <p>Vite, pz. 1</p>
 <p>Cilindro in plastica</p>	 <p>Bullone con dado, pz. 1</p>
 <p>Vite, pz. 4</p>	 <p>Passacavo, pz. 3 e 3 viti</p>
 <p>Spessore in gomma</p>	 <p>x 3</p>

EOB-A02B:

 <p>Stativo</p>	 <p>Piede di stativo</p>
 <p>Cilindro in plastica</p>	 <p>Piede regolabile, pz. 3</p>
 <p>Portadisplay</p>	 <p>Viti, pz. 3</p>
 <p>Bullone con dado, pz. 1</p>	

3 Panoramica dello stativo

EOB-A01B:

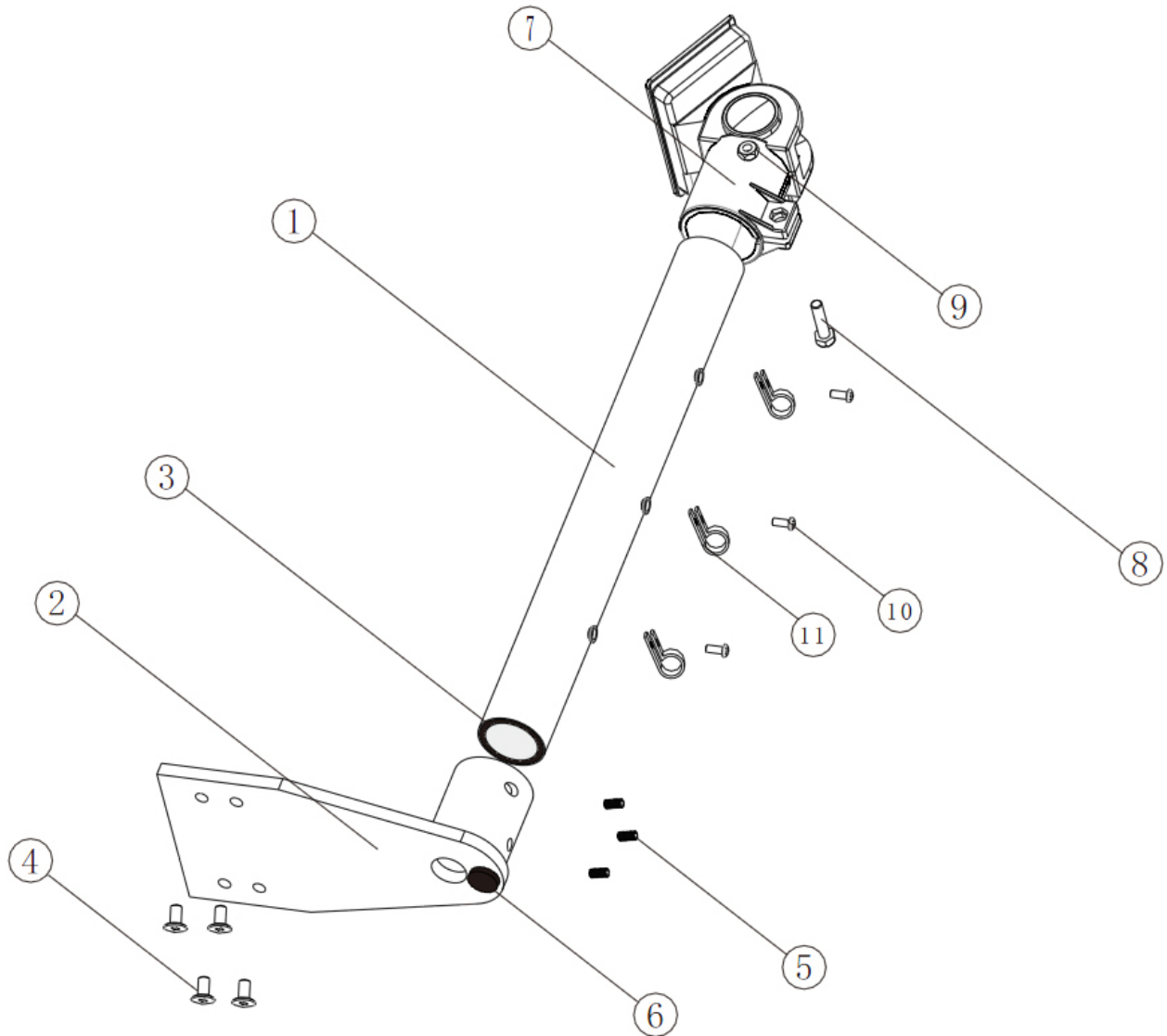

1	Stativo	7	Portadisplay
2	Piede di stativo	8	Vite
3	Cilindro in plastica	9	Vite
4	Vite	10	Vite
5	Vite	11	Passacavo
6	Spessore in gomma		

EOB-A02B:

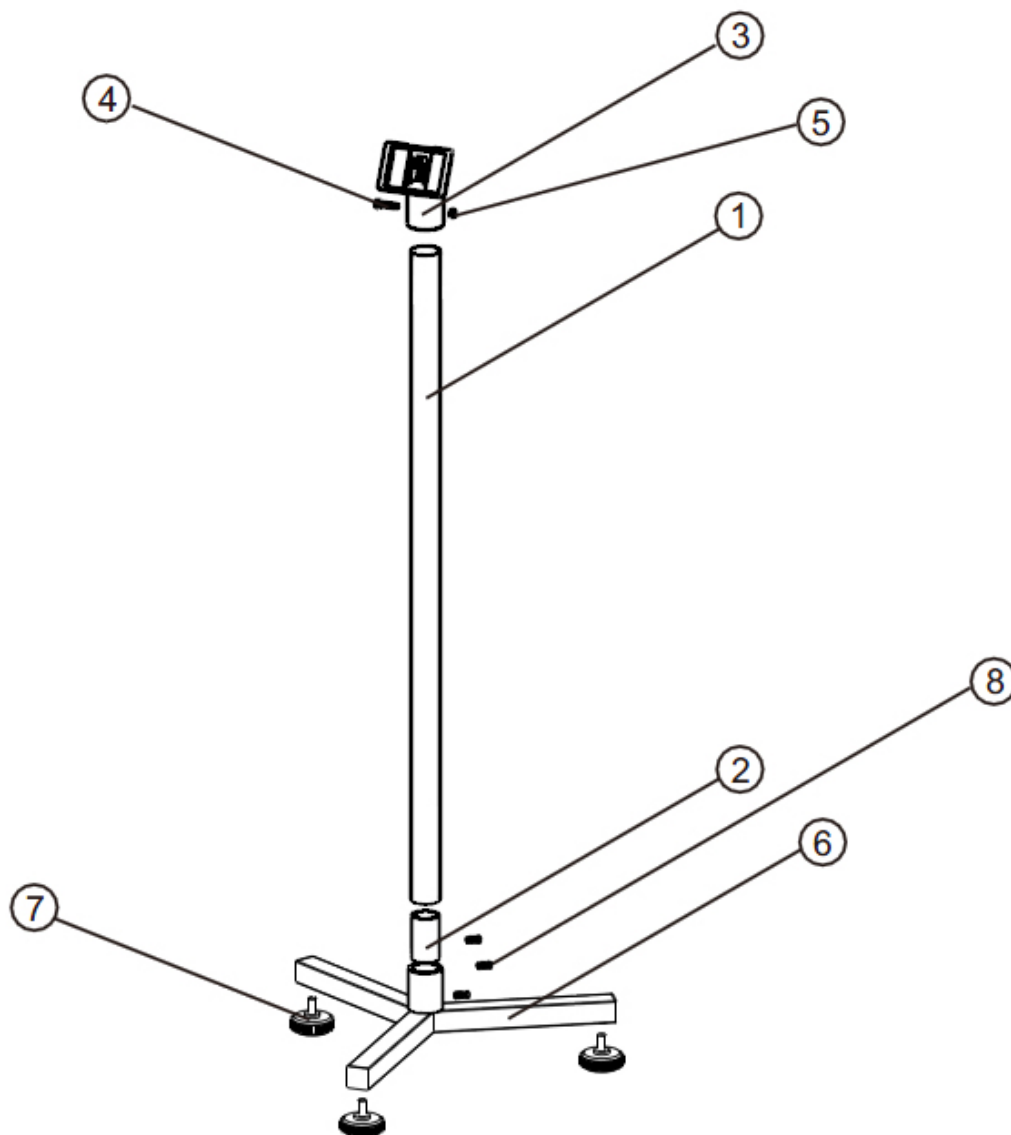

1	Stativo
2	Cilindro in plastica
3	Portadisplay
4	Vite
5	Dado
6	Piede di stativo
7	Piedi con altezza regolabile
8	Viti