



KERN & Sohn GmbH

Ziegelei 1
72336 Balingen-Frommern
Germany

www.kern-sohn.com

+0049-[0]7433-9933-0

+0049-[0]7433-9933-149

info@kern-sohn.com

User manual

Counting scales

KERN CPE

Type TPCE-A

Version 1.0

2021-06

GB



TCPE_A-BA-e-2110



KERN CPE

Ver. 1.0 2021-06

User manual Counting scales

Contents

1	Technical specification	4
2	Declaration of Conformity.....	5
3	Device overview	6
3.1	Parts	6
3.2	Display.....	7
3.3	Keyboard.....	8
4	Basic instructions (general information)	9
4.1	Intended use.....	9
4.2	Non-intended use	9
4.3	Guarantee	9
4.4	Testing equipment supervision	10
5	Basic safety instructions.....	10
5.1	Compliance with the instructions included in the user manual	10
5.2	Personnel training.....	10
6	Transport and storage.....	10
6.1	Checking during reception	10
6.2	Packaging / return transport	10
7	Unpacking, positioning and start-up	11
7.1	Installation place, operation place	11
7.2	Unpacking and check	11
7.3	Integration, setting and leveling.....	12
7.4	Power supply	13
7.5	Rechargeable battery operation	14
7.5.1	Battery charging.....	15
7.6	Connecting peripherals.....	15
7.7	First start	15
7.8	Adjustment	16

8	Operation	17
8.1	Switching on/off	17
8.2	Zeroing	17
8.3	Ordinary weighing.....	17
8.4	Weighing with tare.....	18
9	Counting the number of pieces	18
9.1	Determination of a single piece average weight by weighing	19
9.2	Introducing the average weight of a single piece as the numerical value	20
10	Test weighing.....	21
10.1	Test weighing	21
10.2	Check counting	24
11	Summing.....	27
12	Setup menu	28
13	RS-232 interface.....	29
13.1	Technical specification	29
13.2	Printer mode / protocol templates (KERN YKB-01N)	30
13.3	Printout protocol (continuous data transmission)	30
14	Maintenance, service and disposal.....	31
14.1	Cleaning	31
14.2	Maintenance and service	31
14.3	Disposal	31
15	Error messages	31
16	Help for any minor failures.....	32

1 Technical specification

KERN	CPE 6K-3	CPE 15K-3	CPE 30K-3
Product number / type	TCPE 6K-3-A	TCPE 15K-3-A	TCPE 30K-3-A
Interval (<i>d</i>)	0.2 g	1 g	0.0005 kg
Weighing range (<i>Max</i>)	3000 g	6000 g	15 kg
Reproducibility	2 g	2 g	
Linearity	±0,8 g	±3 g	±0,0015 kg
Minimum piece weight when counting the number of pieces in laboratory conditions*	100 mg	250 mg	500 mg
Minimum piece weight when counting the number of pieces in standard conditions**	1 g	2.5 g	5 g
Adjustment points	2/4/6 kg	5/10/15 kg	10/20/30 kg
Recommended adjustment weight (not delivered)	5 kg (F2)	10 kg (F2); 2 kg (F2)	20 kg (F2); 5 kg (F2)
Weight units	g	g	kg
Settling time (standard)	2 s		
Heating time	120 min		
Air humidity	max. 80%, relative (non-condensing)		
Permissible ambient temperature	0°C to +40°C		
Input voltage of the device	5 V, 1 A		
Input voltage of the power supply	100–240 VAC; 50/60 Hz		
Battery (optional)	3.7 V / 4 Ah		
Rechargeable battery operation	operating time 80 h (illumination off) operating time 50 h (illumination on) charging time ca. 5 h		
housing dimensions [mm]	320 × 340 × 110 (width × depth × height)		
Scale plate, stainless steel [mm]	300 × 230 × 18	300 × 230 × 18	
Net weight [kg]	2.9		
Interface	RS-232		

*** Minimum piece weight when counting the number of pieces in laboratory conditions:**

- There are optimum ambient conditions to count pieces with high resolution
- No diversification of the counted pieces' weight

****Minimum piece weight when counting the number of pieces in standard conditions:**

- There are unsteady ambient conditions (wind gusts, vibrations)
- There is diversification of the counted pieces' weight

Dimensions:

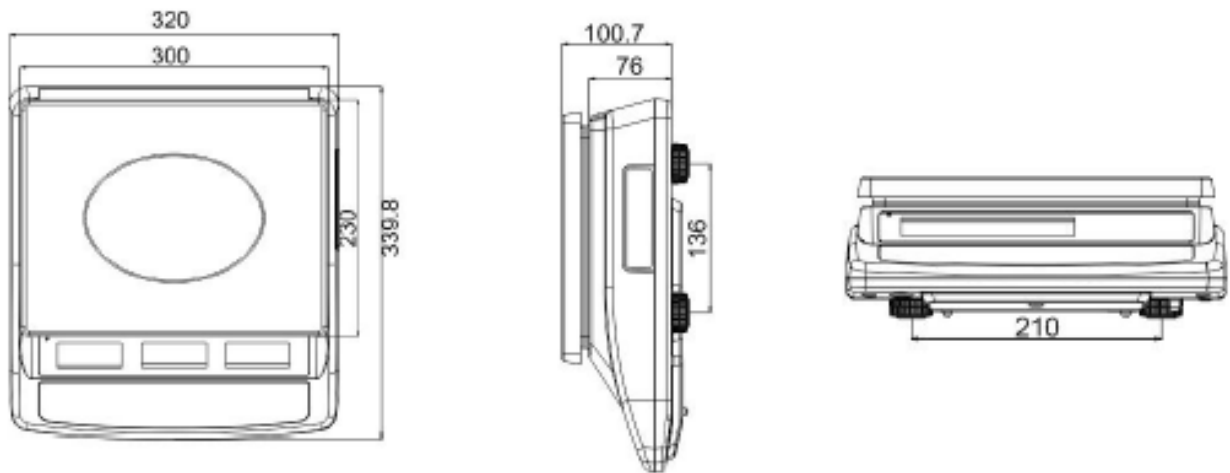

2 Declaration of Conformity

The valid Declaration of Conformity EC/UE is available at:

www.kern-sohn.com/ce

3 Device overview

3.1 Parts





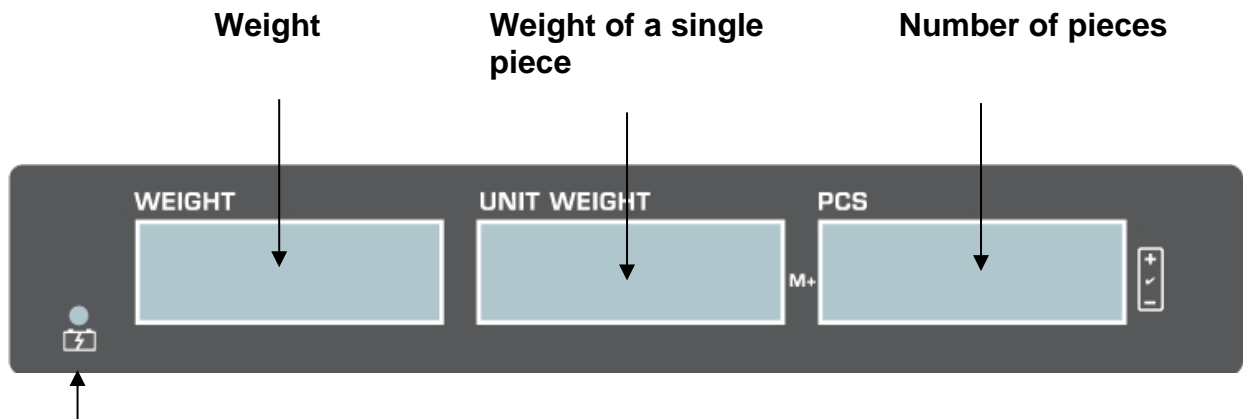

Item	Name
1	Scale plate
2	Display
3	Keyboard
4	RS-232 interface
5	Battery charge indicator
6	Leveler
7	Leveling screw foot
8	Power supply socket

3.2 Display



Battery charge indicator

Symbol	Description
	Battery charging indicator
	Discharged battery
	Tolerance symbols for check weighing, see chapter 10.1
	Stabilization indicator
ZERO	Zero indicator
NET	Net weight value indicator
g	Weight unit "gram"
kg	Weight unit "kilogram"
pcs	Unit of the application "Counting the number of pieces"

3.3 Keyboard

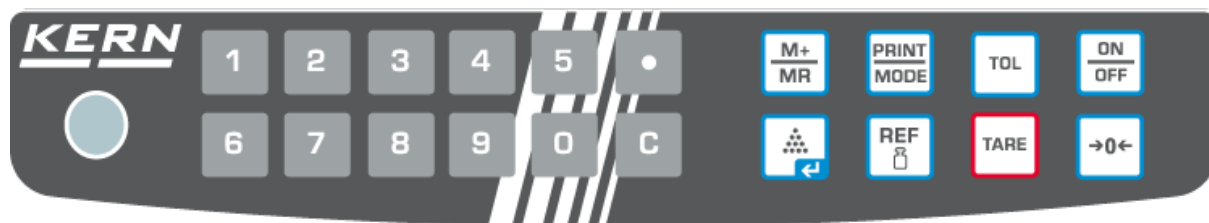

Button	Name	Function in the operating mode	Menu function
		Numerical buttons	–
		Deleting	–
		Decimal point	–
	M Button	Summing Displaying the “total” value	–
	PRINT button	Weight data transfer via the interface	Displaying the configuration menu (by pressing and holding the button)
		Activating/deactivating the test weighing mode	–
	ON/OFF button	Switching on/off	–
	Button	Determination of a single piece average weight by weighing	Selection confirmation / return to the weighing mode
	REF button	Introducing the known weight of a single piece in the numerical value	–
	TARE button	Taring	Selecting the menu item
	ZERO button	Zeroing	Setting change

4 Basic instructions (general information)

4.1 Intended use

The scale you bought is intended for weighing the weighed material. It should be considered a “non-automatic scale”, e.g. the weighed material should be carefully placed manually on the scale plate center. The weight can be read after it has stabilized.

4.2 Non-intended use

The scale is not intended for dynamic weighing, e.g. for removing or adding small amounts of the weighed material. The scale’s “stabilizing and compensating” mechanism can result in displaying erroneous weighing results! (Example: slow outflow of the liquid from the container placed on the scale.)

Do not subject the plate to long-term load. This may damage the weighing mechanism.

Avoid any scale impact and overload higher than the stipulated maximum load (*Max*), deducting the tare from the existing load. This could damage the scale.

Never operate the scale in explosive atmospheres. The standard version is not explosion-proof.

Never introduce any structural modifications to the scale. This may result in displaying erroneous weighing results, violating the technical safety conditions, and also in scale damage.

The scale should always be operated in line with the provided guidelines. Other operation ranges / areas require a written consent of KERN.

4.3 Guarantee

The warranty expires:

- if you fail to follow our guidelines included in the user manual;
- if you fail to use the device in line with the intended use;
- if you introduce any modifications or open the device;
- if the device gets damaged mechanically or damaged by the utilities, liquids and ordinary wear and tear;
- if the device is not set correctly or the electrical system is not as required;
- if the weighing mechanism gets overloaded.

4.4 Testing equipment supervision

Within the quality assurance system, you must check the technical measurement properties of the scale and possibly of the available reference weight regularly. To that aim, the responsible user should define a relevant cycle, as well as the type and scope of such an inspection. The information on the supervision of the testing equipment, i.e. scales, and the required reference weights, can be found on the home page of KERN (www.kern-sohn.com). The reference weights and scales can be calibrated fast and for a low cost in the KERN calibration laboratory (against the national reference) approved by DKD (Deutsche Kalibrierdienst).

5 Basic safety instructions

5.1 Compliance with the instructions included in the user manual



- ⇒ Before you set and start the device, read this user manual thoroughly even if you are familiar with KERN scales.
- ⇒ All language versions contain non-binding translation. Only the original document in German is binding.

5.2 Personnel training

The device can be operated and maintained solely by trained workers.

6 Transport and storage

6.1 Checking during reception

Immediately after you have received the shipment, please check if it is free from any visible outer damage. The same applies for the unpacked device.

6.2 Packaging / return transport



- ⇒ Please keep all the parts of the original packaging in case you had to send it back to us.
- ⇒ Always use the original packaging for the return transport.
- ⇒ Before you dispatch the device, disconnect any connected cables as well as loose/moving parts.
- ⇒ Reinstall any transport locks, if present.
- ⇒ Protect all the parts, e.g. wind breaker, scale plate, power supply etc. from slipping and damage.

7 Unpacking, positioning and start-up

7.1 Installation place, operation place

The scales are designed to ensure reliable weighing results in standard operating conditions.

The choice of a correct scale location ensures its accurate and fast operation.

This is why you should follow the following rules when selecting the installation place:

- Place the scale on stable, flat surface.
- Avoid extreme temperatures and temperature fluctuations, occurring e.g. when you place it at the radiator or in a place exposed to direct sun rays.
- Protect the scale from the direct draft present at open windows and doors.
- Avoid impact when weighing.
- Protect the scale from high humidity of air, vapours and dust.
- Do not expose it to long-term heavy moisture. Any forbidden condensation of the air moisture on the device may occur when a cold device is placed in a much hotter environment. In such circumstances, leave the device not connected to the mains for 2 hours to adapt to the ambient temperature.
- Avoid static discharge from the weighed material and scale container.

If there are any electromagnetic fields, static discharge and unstable power supply, high readout deviations (erroneous weighing results) may occur. In such circumstances, change the location.

7.2 Unpacking and check

Remove the device and accessories from the packaging, remove the packaging material and place the device in the target location. Check if all components included in the delivery are present and not damaged.

Scope of delivery / standard accessories:

- Scale, see chapter 3.1
- Power supply
- User manual
- Dust cover

7.3 Integration, setting and leveling

- ⇒ Remove transport protection.
- ⇒ Install the scale plates as shown in the drawing.

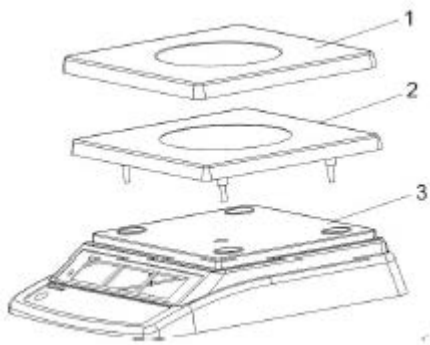

- ⇒ Place the scale on smooth surface.
- ⇒ Level the scale using the leveling feet. The air bubble in the leveler must be present in the marked area.

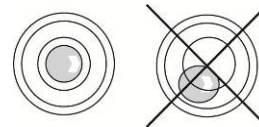
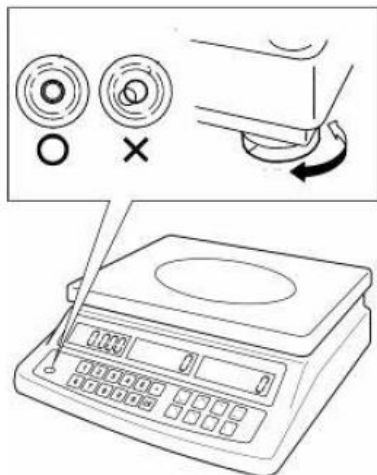

- ⇒ Check leveling at regular intervals.

7.4 Power supply



Check if the scale voltage is set correctly. The scale can be connected to the mains only when the voltage specified on the scale (sticker) and the local voltage are identical.

Always use the original power supply by KERN. Using any other products requires KERN consent.



Important information:

- Before you start the device, check the power cord for damage.
- The power cord must not have any contact with liquids.
- The plug must be always readily available.

7.5 Rechargeable battery operation

PLEASE NOTE!



- ⇒ The rechargeable battery and the charger are compatible. Always use the power supply delivered with the scale.
- ⇒ Do not use the scale when charging.
- ⇒ Always replace the battery with the one of the same type or of the type recommended by the manufacturer.
- ⇒ The battery is not protected against all the environmental impacts. Exposing the battery to specific environmental conditions may result in its fire or explosion. It may result in serious injuries or material losses.
- ⇒ Protect the battery from fire and heat.
- ⇒ Do not allow the battery to have any contact with liquids, chemicals or salts.
- ⇒ Do not expose the battery to high pressure or microwave radiation.
- ⇒ Do not modify any batteries, charger and do not tamper them.
- ⇒ Do not use any faulty, damaged or deformed battery.
- ⇒ Do not connect the electrical contacts of the battery and do not use any metal items to short circuit them.
- ⇒ The electrolyte may be released by the damaged battery. Any contact of the electrolyte with the skin or eyes may irritate them.
- ⇒ When you place or replace batteries, always pay attention to the correct polarity (see the information in the battery compartment).
- ⇒ When the power supply is connected, the battery operation mode is switched off. Always remove the battery for weighing in the power supply mode longer than 48 h! (Overheating danger).
- ⇒ If you detect any odour emitted by the battery, its heating, discolouration or deformation, disconnect it immediately from the power supply and, whenever possible, from the scale.

7.5.1 Battery charging

The rechargeable battery is charged using the supplied power cord.

Before first use, charge the battery for at least 5 hours using the power cord.



The battery symbol displayed on the screen means that the battery capacity will soon run down. The device may operate ca. 1 hour longer and then it will be switched off automatically. When the scale operates further without charging, a blinking <B-ERR> symbol will be displayed.

Charge the battery using the provided power supply.

When charging, LED indicator at the bottom, to the left of the weight indicator, indicates the battery charging status.

red: The battery is being charged

green: The battery is fully charged

7.6 Connecting peripherals

Before you connect or disconnect any extra devices (printer, computer) to/from the data interface, the scale should always be disconnected from the mains.

Use solely accessories and peripherals supplied by KERN with the scale, being perfectly compatible with it.

7.7 First start

To get accurate weighing results using electronic scales, ensure the scales achieves the appropriate operating temperature (see "Heating time", chapter 1). During the heating time, the scale must be connected to the power source (the socket, rechargeable battery or batteries).

The scale accuracy depends on the local standard gravity.





Always follow the guidelines in the "Adjustment" chapter.

7.8 Adjustment

As the standard gravity value is not the same in every spot on Earth, every display with the scale plate connected should be adjusted, in line with the weighing rules resulting from the laws of physics, to the standard gravity in the scale location (provided the scale system has not already been subject to factory adjustment in its location). Such an adjustment process should be carried out during the first start, following every location change and also in the case of any ambient temperature fluctuations. To ensure achieving accurate measurement data, it is also recommended to carry out regular display adjustment also in the weighing mode.

- i** • Prepare the required adjustment weight, see chapter 1. Whenever possible, adjust using the adjustment weight with the weight similar to the maximum load of the scale (the adjustment weight is recommended, see chapter 1). The adjustment may also be carried out using weights with other nominal values or tolerance classes, but this is not optimal from the measurement technique perspective. The adjustment weight precision must correspond to the interval $[d]$ of the scale, though preferably it should be a bit higher. For information concerning reference weights, see online at: <http://www.kern-sohn.com>
- Ensure stable environmental conditions. The heating time is required for the stabilization (see chapter 1).
- Ensure there are no objects on the scale plate.

What to do:

- ⇒ Switch the scale on and when the autotest is carried out, press and hold the  button until the <ZERO ONE CAL> is displayed.
- ⇒ Release the button . <----- ONE CAL> and then the blinking symbol of the first adjustment point will be displayed.
- ⇒ Using the **ZERO** button, select the required adjustment weight, see chapter 1 “Adjustment points” or “Recommended adjustment weight”.
- ⇒ Place the adjustment weight and confirm by pressing .
- ⇒ Wait until <PASS> is displayed.
- ⇒ Remove the adjustment weight.
- ⇒ Press . After the successful adjustment, the scale will switch to the weighing mode again automatically.
If there is any adjustment error or if an incorrect adjustment weight is used, the error message is displayed. Repeat the adjustment process.

8 Operation

8.1 Switching on/off

Switching on:

- ⇒ Press the **ON/OFF** button.
Once the display is lit, the scale autotest will be carried out.
Wait until the weight is displayed, the scale is ready for use.

Switching off:

- ⇒ Press the **ON/OFF** button, the display will go off.

8.2 Zeroing

Zeroing corrects the effect of small pollutants on the scale plate.

- ⇒ Remove the load from the scale.
- ⇒ Press **ZERO**, the zero indications and **<ZERO>** symbol will be displayed.

8.3 Ordinary weighing

- ⇒ Check the zero indication, whenever required zero by pressing the **ZERO** button.
- ⇒ Place the weighed material.
- ⇒ Wait until the stabilization indicator is displayed .
- ⇒ Read out the weighing result.



Overload warning



Always avoid any device overload higher than the stipulated maximum load (*Max*), deducting the tare from the existing load. This could damage the device.

The exceeded maximum load is indicated with **--o!--**. Reduce the scale load or reduce the initial load.

⇒

8.4 Weighing with tare

The empty weight of any container used for weighing can be tared, pressing the button which results in displaying the net weight of the weighed material during consecutive weighing processes.

- ⇒ Place the scale container on the scale plate.
- ⇒ Wait until the stabilization indicator is displayed , and press **TARE**. The container weight is saved in the scale memory. The zero indicator and the “**NET**” symbol will be displayed. “**NET**” indicates all displayed weight values are net values.
- ⇒ Place the weighed material.
- ⇒ Wait until the stabilization indicator is displayed .
- ⇒ Read out the net weight.



- After the load is removed from the scale, the tare weight is displayed as a negative value.
- To delete the saved tare value, remove the load from the scale plate and press **TARE** button.
- The taring process can be repeated any number of times, e.g. when weighing several mixture ingredients (making up the weight). The limit is reached when the complete taring scope is used.

9 Counting the number of pieces

Before it is possible to count pieces using the scale, you should determine the average weight of an individual piece (unit weight), the so-called reference value. To do it, place the specific number of pieces which the counting the number of pieces will be carried out for. The scale will determine the total weight which will be divided by the number of pieces, the so-called reference piece number. Next, based on the calculated mean weight of an individual piece, the number of pieces will be counted.





- The higher number of the reference pieces, the higher the accuracy of counting the number of pieces.
- For small or highly diverse pieces, the reference value must be sufficiently high.
- For the minimum weight of the counted pieces, see the “Technical specification” table.
- The function is available starting from weight values above 20 *d*.
- Whenever required, when adding consecutive pieces with the number lower than the placed reference load, the reference weight will be recalculated by the scale. Such a reference value optimisation is indicated by an audible signal.

9.1 Determination of a single piece average weight by weighing

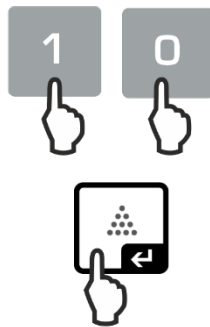
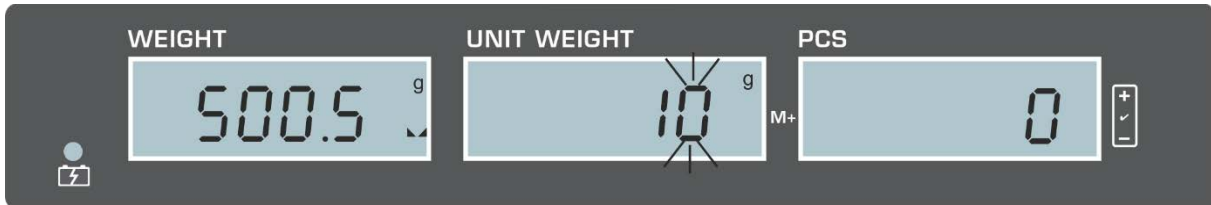

⇒ Zero the scale or, whenever required, tare the empty scale container.



⇒ Place the known number of individual pieces as a reference load. Use numerical buttons to enter the number of reference pieces and confirm by pressing . The "SAMP" symbol will be displayed for a while. The mean weight of an individual piece will be determined by the scale and then the piece quantity will be displayed.



⇒ Remove the reference load. The scale is in the counting mode and counts all pieces present on the scale plate.



Deleting the mean amount of a single piece:

⇒ Press .

9.2 Introducing the average weight of a single piece as the numerical value



⇒ Zero the scale or, whenever required, tare the empty scale container.

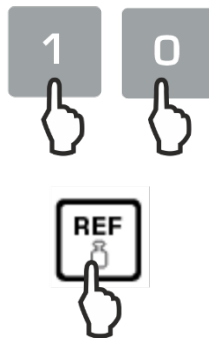
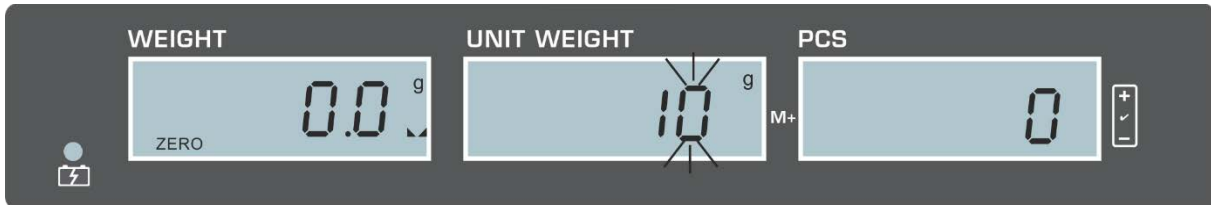

⇒ Using numerical buttons, enter the known average weight of a single piece, e.g. 10 g, and confirm by pressing **REF**.



⇒ The scale is in the counting mode and counts all pieces present on the scale plate.



Deleting the mean amount of a single piece:

⇒ Press **C**.

10 Test weighing

i The function is available starting from weight values above 20 *d*.

Activating the test weighing mode:

- ⇒ In the weighing mode, press the **TOL** button, <**CK OFF**> will be displayed.
- ⇒ Pressing the **TOL** button enables to switch between <**CK OFF**> and <**CK ON**>.
 - <**CK OFF**> function deactivated
 - <**CK ON**> function activated



10.1 Test weighing

The <**Test weighing**> application enables to determine the upper and lower limit value and, consequently, to ensure the weight of the weighed material belongs to the range between the determined tolerance limits.

Exceeding the limit values (fall below and rise above) is signaled with a visual indication (tolerance symbols) and an audible indication.

Visual signal:

The triangle displayed at the right edge of the symbol provides the following information:

▶ 	The weighed material above the preset limits
▶ 	Weighed material in the preset limit range
▶ 	The weighed material below the preset limits

Selection of the test weighing mode:

- ⇒ In the weighing mode, press and hold the **TOL** button for 3 s, the <**LIMIT – PCS-TYPE**> symbol will be displayed.
- ⇒ Pressing **TOL** enables to switch between <**LIMIT – PCS-TYPE**> of the test counting mode and <<**LIMIT – WEIGHT-TYPE**> of the test weighing mode.
- ⇒ Confirm the selection, pressing . A symbol used for introducing the sending conditions <**LIMIT – HI-MODE**> will be displayed.

Setting conditions of sending and limits:

- When <LIMIT – HI-MODE> is displayed, use the **TOL** button to select the required sending condition.
You can choose:

In	<ol style="list-style-type: none"> If the weighed portion is in the present limit range, a sound is heard and a triangle is displayed at the [✓] symbol. If the weighed portion is below the lower limit value, the sound is not heard and the triangle is displayed at the [-] symbol. If the weighed portion is above the upper limit value, the sound is not heard and the triangle is displayed at the [+] symbol.
OUT	<ol style="list-style-type: none"> If the weighed portion is in the preset limit range, the sound is not heard and the triangle is displayed at the [+] symbol [✓]. If the weighed portion is below the lower limit value, the sound is heard and the triangle is displayed at the [-] symbol. If the weighed portion is above the upper limit value, the sound is heard and the triangle is displayed at the [+] symbol.
HI	<ol style="list-style-type: none"> If the weighed portion is above the upper limit value, the sound is heard and the triangle is displayed at the [+] symbol. If the weighed portion is below the lower limit value, the sound is not heard and the triangle is displayed at the [-] symbol.
LO	<ol style="list-style-type: none"> If the weighed portion is below the lower limit value, the sound is heard and the triangle is displayed at the [-] symbol. If the weighed portion is above the lower limit value, the sound is not heard and the triangle is displayed at the [+] symbol.

- Confirm the selection by pressing , <LIMIT – STABL-CHECK> will be displayed.
- Select the required setting, pressing **TOL**.

LIMIT-STABL-CHECK	The sound can be heard solely for stable weighing values.
LIMIT-UNSTA-CHECK	The sound can be heard solely for stable and unstable weighing values.

4. Confirm the selection by pressing . The window for value entry in the numerical form will be displayed where you can enter the upper limit value.



5. Using numerical buttons, enter the upper limit value, e.g. 2 kg in the displayed unit (e.g. gram) and confirm by pressing .
6. The window for value entry in the numerical form will be displayed where you can enter the lower limit value.



7. Using numerical buttons, enter the lower limit value, e.g. 1.5 kg in the displayed unit (e.g. gram) and confirm by pressing . The scale will switch to the weighing mode again.

Tolerance check start:

- ⇒ Ensure the test weighing mode is active. To do it, press **TOL** and, whenever required, use **TOL** to select **<CK ON>**.
- ⇒ Place the weighed material (< 20 d) and, based on the tolerance symbols / audible signal, check if the weighed material belongs to the preset tolerance range.

Weighed material below the preset tolerance



Weighed material in the preset tolerance range



Weighed material above the preset tolerance



10.2 Check counting

The **<Test counting>** application enables to determine the upper and lower limit value and, consequently, to ensure that the target number of pieces belongs to the range between the determined tolerance limits.

Selection of the test counting mode:

- ⇒ In the weighing mode, press and hold the **TOL** button for 3 s, the current setting will be displayed.
- ⇒ Pressing **TOL** enables to switch between **<LIMIT – PCS-TYPE>** of the test counting mode and **<<LIMIT – WEIGHT-TYPE>** of the test weighing mode.
- ⇒ Confirm the selection, pressing . A symbol used for introducing the signaling conditions **<LIMIT – HI-MODE>** will be displayed.

Setting conditions of sending and limits:

- ⇒ Using the **TOL** button, select the required signaling condition. For selection options see chapter 10.1 / step 1:
- ⇒ Confirm the selection by pressing **▲**, <**LIMIT – STABL-CHECK**> will be displayed.
- ⇒ Select the required setting, pressing **TOL**.

LIMIT-STABL-CHECK	The sound can be heard solely for stable weighing values.
LIMIT-UNSTA-CHECK	The sound can be heard solely for stable and unstable weighing values.

- ⇒ Confirm the selection by pressing **▲**. The window for value entry in the numerical form will be displayed where you can enter the upper limit value.



- ⇒ Using numerical buttons, enter the upper limit value, e.g. 100 pieces, and confirm by pressing **▲**.
- ⇒ The window for value entry in the numerical form will be displayed where you can enter the lower limit value.



- ⇒ Using numerical buttons, enter the lower limit value, e.g. 90 pieces, and confirm by pressing **▲**. The scale will switch to the weighing mode again.

Tolerance check start:

- ⇒ Ensure the test weighing mode is active. To do it, press **TOL** and, whenever required, use **TOL** to select **<CK ON>**.
- ⇒ Ensure the average weight of a single piece is set (see chapter 9).
- ⇒ Place the weighed material (< 20 *d*) and, based on the tolerance symbols / audible signal, check if the weighed material belongs to the preset tolerance range.

Weighed material below the preset tolerance



Weighed material in the preset tolerance range



Weighed material above the preset tolerance



11 Summing

The function enables to add the number of pieces to the total memory by pressing the button.



The function is available starting from weight values above 20 d.

Summing the weighed material:

- ⇒ Ensure the average weight of a single piece is determined (see chapter 9).
- ⇒ Whenever required, place an empty container on the scale and tare it.
- ⇒ Place the first weighed material. Wait until the stabilization indicator is displayed, then press **M**. The number of pieces is added to the total memory. The number of weighing procedures and the number of pieces are displayed for ca. 3 s intermittently with the currently placed weight.
- ⇒ Remove the weighed material. The subsequent weighed material can be added only when the indication \leq zero.
- ⇒ Place the second weighed material. Wait until the stabilization indicator is displayed, then press **M**. The number of pieces is added to the total memory. The number of weighing procedures and the number of pieces are displayed for ca. 3 s intermittently with the currently placed weight.
- ⇒ Whenever required, add the subsequent weighed material as described above. Load should be removed from the scale between consecutive weighing procedures.
- ⇒ This process may be repeated 99 times until you reach the scale weighing range.

Displaying the “total” value:

- ⇒ When zero is displayed, press **M**. The total number of pieces and the number of weighing procedures will be displayed for ca. 3 s.

Deleting the total memory:

- ⇒ When zero is displayed, press the **M** button. When the total weight is displayed, press **C**.

12 Setup menu

The setup menu enables to adapt the scale settings / scale behavior to your requirements (e.g. ambient conditions, special weighing processes).

Menu navigation:

Displaying the menu	⇒ In the weighing mode, press and hold the PRINT button for 3 s, the first menu item < BUAD96 USER SETUP > will be displayed.
Selecting the menu item	⇒ Individual menu items can be selected consecutively, pressing TARE .
Setting selection	⇒ Confirm the selection of the menu item by pressing the ZERO button. The first setting will be displayed.
Changing settings	⇒ The ZERO enables to switch between the available settings.
Setting confirmation / Menu leaving	⇒ Press  , the scale will switch to the weighing mode again.

Overview:

Menu item	Settings	Description
BuAd96 Transmission speed	BuAd96	Transmission speed 9600
	BuAd48	Transmission speed 4800
RS CO Data transmission	rS oFF	Data transmission off
	rS Co	Continuous data transmission of stable/unstable weighing values
	rS SCo	Continuous data transmission of stable weighing values
	rS St	Data transmission for an unstable weighing value
	rS Pr	Data transmission after PRINT is pressed
bl-AY Display back-light	bl-AY	The backlight is switched on automatically when load is changed or when the device is operated
	bl-on	Display backlight always on
	bl-oFF	Display backlight always off
FiLt-1 Filter	FiLt-1 ~ FiLt-5	Adaptation to the ambient conditions, you can select from FiLt-1 ~ FiLt-5 in the displayed unit (e.g. gram) The higher the filter degree, the faster the response time.

SEnS-6 Sensitivity	SEnS-0~ SEnS-9	Adaptation to the ambient conditions, you can select from SEnS-0~ SEnS-9. The higher the degree, the higher the sensitivity.
Zero-0 Maintaining zero	Zero-0 ~ Zero-9	Automatic zero maintenance, possible to choose from 0 <i>d</i> – 9 <i>d</i>
		i If the amount of the weighed material is reduced or increased significantly, the scale's "stabilizing and compensating" mechanism can result in displaying erroneous weighing results! (e.g.: slow outflow of the liquid from the container placed on the scale, evaporating processes). When dosing with small weight fluctuations, it is recommended to switch this function off.
L-AZ-0 Setting a decimal point	L-AZ 0 ~ L-AZ 9	The load scope where the scale returns to zero, you can choose from 0 <i>d</i> – 9 <i>d</i>

13 RS-232 interface

RS-232 ensures two-way data exchange between the scale and external devices. Data is sent asynchronously in ASCII code.

To ensure communication between the balance and the printer, the following conditions must be met:

- Connect the scale with the printer interface using the appropriate cable. Trouble-free operation is ensured only when the appropriate interface cable by KERN is used.
- Communication parameters (e.g. transmission speed) of the scale and the printer must be compliant.

13.1 Technical specification

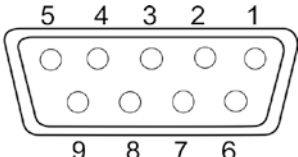
Port	9-Pin--pin mini D-Sub plug	
		
	Pin 2 RXD	Input
	Pin 3 TXD	Output
	Pin 5 GND	Signal ground
Transmission speed	The choice of 4800/9600	

13.2 Printer mode / protocol templates (KERN YKB-01N)

Counting the number of pieces

±1500,0g
10g/pcs
150PCS

Weight

Weight of a single piece

Number of pieces

Summing

No possibility to connect with the printer

13.3 Printout protocol (continuous data transmission)

Byte	1	2	3	4	5	6	7	8	9	10	11	12	13
	+	<20>	<20>	1	0	7	4	.	5	g	<CR>	<LF>	
	-	<20>	<20>	<20>	<20>	5	0	.	6	g	<CR>	<LF>	
O	L												

Nr	Description
1	The sign (plus/minus); alphabet: O
2 ~ 8	7 bits of weighing value including the decimal point
9 ~ 10	Weight unit
11 ~ 12	End symbol
<20>	Space

14 Maintenance, service and disposal



Before you start any works related to the maintenance, cleaning and repair, disconnect the device from the operating voltage.

14.1 Cleaning

Do not use any aggressive cleaning agents (solvents etc.), but clean the device with a cloth and mild soap solution. The liquid must not get inside the device. Wipe with a dry, soft cloth.

Any loose specimen/powder remains can be removed carefully with a brush or a handheld vacuum cleaner.

Remove any scattered weighed material immediately.

14.2 Maintenance and service

- ⇒ The device can be operated and maintained solely by the technicians trained and authorized by KERN.
- ⇒ Disconnect from the mains before opening.

14.3 Disposal

The packaging and the device should be disposed in accordance with the national or regional law in the location where the device is operated.

15 Error messages

Error message	Explanation
--ol--	Overloading
B-ERR	Discharged batteries/rechargeable batteries
Err 9	Summing error
P-ERR	Average weight of a single piece outside the range

16 Help for any minor failures

If there are any program execution problems, the scale should be switched off and disconnected from the mains for a while. Next, the weighing process should be started anew.

Problem	Possible cause
The weight indicator is not lit.	<ul style="list-style-type: none">• The scale is not on.• Interrupted mains connection (mains cable not connected/damaged).• Mains voltage failure.
The weight indication keeps fluctuating.	<ul style="list-style-type: none">• Draft / air movements.• Table/air vibrations.• The scale plate is in contact with foreign bodies.• Electromagnetic fields / static discharge (select another location / if possible, switch off the interfering device).
The weighing result is clearly wrong.	<ul style="list-style-type: none">• The scale indication was not reset.• Incorrect adjustment.• Scale not placed on a level surface.• There are heavy temperature fluctuations.• The heating time not observed.• Electromagnetic fields / static discharge (select another location / if possible, switch off the interfering device).