

Operating manual

Programmable Data Logger HD32MT.1



Members of GHM GROUP:

GREISINGER

HONSBERG

Martens

Delta OHM

VAL.CO

www.deltaohm.com

Keep for future reference.

TABLE OF CONTENTS

1	INTRODUCTION	5
1.1	GLOSSARY	7
2	TECHNICAL CHARACTERISTICS	8
3	DESCRIPTION OF TERMINAL BOARD	9
4	INSTALLATION	11
4.1	START-UP OF AN ALREADY CONFIGURED DATA LOGGER	11
4.2	START-UP BY MODIFYING THE DATA LOGGER CONFIGURATION	12
4.3	DATA LOGGER INSTALLATION WITH CREATION OF THE CONFIGURATION	13
5	ELECTRICAL CONNECTIONS	14
5.1	POWER SUPPLY INPUT	14
5.2	POWER SUPPLY OUTPUTS	16
5.3	ANALOG INPUTS	17
5.3.1	CONNECTION OF SENSORS AND TRANSMITTERS WITH OUTPUT VOLTAGE	18
5.3.2	CONNECTING SENSORS AND TRANSMITTERS WITH CURRENT OUTPUT	21
5.3.3	CONNECTION OF 2-WIRE RESISTIVE SENSORS	23
5.3.4	CONNECTION OF 3-WIRE POTENTIOMETRIC SENSORS	24
5.3.5	CONNECTION OF 4-WIRE RESISTIVE SENSORS	24
5.3.6	CONNECTION OF THERMOCOUPLES	25
5.4	DIGITAL INPUTS AND OUTPUTS	26
5.5	INPUTS FOR PULSE COUNTING	27
5.5.1	HIGH FREQUENCY PULSE COUNTING	27
5.5.2	COUNTING NUMBER OF OPENING/CLOSING OF VOLTAGE-FREE CONTACTS	27
5.6	RS485 CONNECTION	29
5.7	EXTENDING THE NUMBER OF INPUTS	30
5.8	ALARM OUTPUTS	31
5.9	GROUNDING	31
5.10	HOW TO READ THE WIRING DIAGRAM	33
5.11	EXAMPLES OF METEOROLOGICAL STATIONS	34
6	CONNECTION TO THE PC	38
6.1	RS232 OR USB DIRECT CONNECTION VIA CABLE	38
6.2	CONNECTION VIA RS485 LINE	39
6.3	CONNECTION VIA OPTICAL FIBER	39
6.4	CONNECTION VIA RADIO MODEM (ONLY FOR THE RADIO MODEM VERSION)	40
6.5	CONNECTION VIA ETHERNET LOCAL AREA NETWORK	41
6.6	CONNECTION VIA INTERNET WITH IP MODEM AND TCP/IP SERVER PROTOCOL	42
7	GSM CONNECTION	43
8	CHANGING THE CONFIGURATION	45
8.1	CONNECTING TO THE PC AND READING THE PROGRAM INSTALLED	45
8.2	CHANGING THE INSTALLED PROGRAM	49

8.2.1	CHANGING THE MEASUREMENT RECORDING INTERVAL.....	49
8.2.2	CHANGING THE PARAMETERS OF A SENSOR	51
8.2.3	ADDING A SENSOR	53
8.2.4	REMOVING A SENSOR	56
8.3	INSTALLING THE CHANGED PROGRAM IN THE DATA LOGGER	58
9	CREATION OF THE CONFIGURATION	59
9.1	CREATING THE PROGRAM FILE	59
9.2	LIST OF SENSORS AND SETTING OF PARAMETERS	60
9.2.1	UNIPOLAR VOLTAGE AND BIPOLAR VOLTAGE CONFIGURATION.....	65
9.2.2	RESISTANCE DIVIDER CONFIGURATION	68
9.2.3	RESISTANCE DIVIDER 4-WIRE CONFIGURATION	72
9.2.4	ADDER PULSES → DIGITAL/ANALOG PULSES CONFIGURATION	74
9.2.5	ADDER PULSES → SWITCH CLOSURE CONFIGURATION	77
9.2.6	INPUT CURRENT 4-20 AND 0-20MA CONFIGURATION.....	79
9.2.7	DIGITAL INPUT CONFIGURATION	82
9.2.8	MODBUS RTU CONFIGURATION	83
9.2.9	SERIAL CHANNELS CONFIGURATION	85
9.2.10	GPS CONFIGURATION	87
9.2.11	U.S. ANEMOMETERS HD2003 AND U.S. ANEMOMETERS HD52.3D CONFIGURATIONS	88
9.2.12	RAIN GAUGE CONFIGURATION	90
9.2.13	RADIOMETRY CONFIGURATION	91
9.2.14	PT100-PT1000 THERMOMETERS CONFIGURATION	94
9.2.15	THERMOCOUPLES CONFIGURATION	96
9.2.16	NTC THERMISTOR CONFIGURATION	98
9.2.17	ERROR MESSAGES WHILE SETTING THE PARAMETERS	100
9.3	DEFINING THE CALCULATED QUANTITIES.....	100
9.4	CREATING THE STORE TABLES	104
9.4.1	ALARMS TABLE	108
9.4.2	CAPACITY OF THE INTERNAL MEMORY	111
9.5	SAVING THE PROGRAM IN THE PC	113
9.6	INSTALLING THE PROGRAM IN THE DATA LOGGER	115
9.6.1	ERROR MESSAGES DURING CONNECTION	119
10	“MODBUS SLAVE” MODE	120
11	MEMORY CARD.....	123
12	LED SIGNALS	124
13	HOUSING OPENING ALARM	125
14	DISPLAY	126
14.1	DISPLAY FUNCTIONS	128
14.2	PC-DATA LOGGER CONNECTION IN PRESENCE OF THE DISPLAY	130
15	LITHIUM BATTERY REPLACEMENT	131
16	MOUNTING THE DATA LOGGER	132

17 INSTRUMENT STORAGE	133
18 SAFETY INSTRUCTIONS	133
19 ORDER CODES	134
20 OUTDOOR HOUSINGS DESCRIPTION	136
APPENDIX A – ERROR CODES	141

1 INTRODUCTION

The **HD32MT.1** is a data logger capable of capturing and logging the values measured by a series of sensors connected to its inputs.

The data logger is completely programmable by the user and is therefore very versatile. The supplied **HD32MTLogger** application software, supplied with the instrument, allows simple and intuitive programming by using graphic interfaces, without the need of learning any programming language, thus minimizing the time needed to make the system operational. The configuration of the data logger is password protected, which prevents unauthorized modifications of the system.

The values recorded by the instrument can be transferred to a PC by using the **HD32MTLogger** software. The data logger can be configured to memorize the instant value, the minimum value, the maximum value, the average value and the standard deviation of the measurements. For measurements that require the counting of pulses, the total counted pulses can be stored.

Different recording intervals can be programmed for the various inputs, by defining up to 8 storing tables. Each recording includes acquisition date and time

The data logger has a "flash" internal memory arranged in circular mode: when the memory is full the new data overwrite the older ones. The number of storable measurements depends on the number of sensors employed, on the type of measurement to be stored and on the fact that the sensors are acquired all at the same time or at different instants. For example, with 11 sensors captured at the same time, 80,000 records can be stored, each one composed of 11 instantaneous measurements.

Data can also be saved in a removable **SD**-type memory card with a capacity of **8 GB**. The use of a memory card allows extending the memory capacity of the instrument, allowing not losing the data when the internal memory is full. The acquired data are transferred to the memory card every **15 minutes**.

Several communication possibilities between the data logger and the PC/PLC are available. In the basic version of the data logger, the communication with the PC for data transfer or programming is done via RS232C serial connection. An optional adapter (C.205) allows connecting the data logger to a USB port of the PC. Using optional external modules, to be connected to the data logger serial ports, allows extending the connection possibilities:

- **RS485** connection: the data logger can be connected to RS485 lines by using the optional external RS232/RS485 converter HD7520R. The data logger can also operate as "Modbus Slave" unit with **Modbus-RTU** protocol.
- **Optical fiber** connection: it is possible the connection to the optical fiber by using the optional external HDTCF-142-M module (the module can also be used to connect, via optical fiber, the data logger RS485 port to sensors with RS485 output).
- Connection with **Radio Modems**: the communication takes place by **VHF** radio using the optional external HDRMO169 radio modems.
- Connection via **Internet IP modem**: a communication between instrument and PC can be established via Internet with **TCP/IP Server** protocol through the use of the external optional WCDMA/HSDPA/HSUPA IP modem HDF2414. In the modem must be inserted a SIM card (not included).
- **Ethernet** connection: the communication takes place via Ethernet local network (LAN) by using the optional external HD5110 module. If the optional external HDMB3180 module is used, the communication takes place with **Modbus TCP/IP** protocol (the data logger operates as "Modbus-RTU Slave" unit).
- **GSM/UMTS** connection: all versions can be equipped with the optional external HD5320 GSM/UMTS module, through which you can send alarm **SMS** to mobile phones and send every 15 minutes the recorded data by **e-mail** or to an **FTP** address. In the module must be inserted a SIM card (not included). On request, the module can be

supplied with the GPS option, to automatically update the clock of the data logger and identify the installation site (**latitude, longitude, altitude**).

The communications via VHF or IP modem and via GSM module are especially useful for installations in remote unattended sites.

The instrument can be connected to the most common sensors used in industrial and environmental fields, with both analog and digital output.

The typical sensors that can be connected to the instrument are:

- sensors with analog voltage output, both unipolar and bipolar;
- sensors with analog current output (0...20 mA, 4...20 mA);
- thermocouple temperature sensors (type K, J, T, N, R, S, B, E);
- Pt100/Pt1000 and NTC temperature sensors;
- sensors with digital output TTL level pulse (ON/OFF);
- resistive and potentiometric sensors (e.g. wind vane sensor);
- sensors with open/close contact output (e.g. rain gauges, cup anemometers);
- sensors with RS485 output and MODBUS-RTU or proprietary protocol;
- HD2003 and HD52.3D series Delta Ohm anemometers.

The values measured by the sensors can be used to calculate and store derived quantities. The following default derived quantities are available:

- Dew Point;
- Heat Index;
- Wind Chill;
- Saturation Vapor Pressure;
- Standard Evapotranspiration ET_0 with FAO and ASCE Penman-Monteith method.

The **HD32MTLogger** software allows to create derived quantities defined by the user.

There are potential-free contact alarm outputs and digital alarm outputs. The outputs are activated if the values measured by sensors connected to data loggers exceed the programmed thresholds or if sensors or data logger failures occur.

The instrument is particularly suitable for use in weather stations, for the detection and remote transmission of climatic variables. Delta Ohm manufactures a wide range of sensors for measuring environmental variables that can be connected to the data logger, including sensors for measuring temperature, humidity, barometric pressure, wind speed, solar radiation, amount of rainfall, etc.

The data logger can be supplied with a program of measures and stores pre-installed according to specifications of the customer, in order to be operational immediately after installation of the system. The program is installed directly from Delta Ohm to meet the required specifications when ordering.

The data logger configuration (measurement acquisition and recording program, GSM settings, etc.) is password protected.

Power supply from 12 to 30 Vdc. The system can also be powered by a solar panel and backup battery of adequate capacity, allowing for installation in remote sites without electrical power.

An internal lithium battery keeps the date and time of the instrument in the absence of external power.

1.1 GLOSSARY

Gain	Gain of a device, or the change in output signal compared to the change of the input signal that has generated the output change.
Ground loop	Unwanted current flow caused by the difference in potential between two distinct points of land. It is the cause of noise signal superimposed on the relevant measure.
GPS	<i>Global Positioning System</i> . Navigation system based on a network of satellites capable of sending to a mobile device information on its location and time.
GSM	<i>Global System for Mobile Communication</i> . Digital mobile phone standard based on a capillary network of fixed reception/transmission structures (cellular network) that work as repeater stations for the signals of the mobile devices.
Differential input	Input of a device that can detect the difference between two signals. Requires a 2-wire connection (one wire per signal), and a common reference point for the signals and the device.
Single-line input (single ended)	Device input to detect the value of a signal with respect to a common reference point to the signal and the device. It is also referred to as "single-ended".
Current loop	Two-wire connection between a transmitter and a receiver device in which the signal information is the current value imposed by the transmitter on the line connecting.
Memory Card	Miniature, removable storage device to transfer data from one digital device to another.
Modbus-RTU	Serial communication protocol, widespread especially in industrial environment.
Offset	Fixed value that is added to or subtracted from the value of a signal or a measure.
Radio Modem	Modem device for transmitting radio frequency (wireless).
RS485	Standard two-wire serial transmission that allows the long distance connection of multiple devices in a multi point network. Usually used in industrial environment.
Shunt	Resistor inserted in series to a line, which allows to convert the current flowing along the line in a voltage signal.
Common voltage	Maximum voltage that can be applied to the input of a device, compared to the reference of its supply voltage, without causing saturation.

2 TECHNICAL CHARACTERISTICS

Sizes / Weight	222 x 140 x 63 mm / About 1 kg
Case material	Coated aluminium
Operating conditions	-20 ... 50 °C, 0 ... 85% RH no condensation
Storage temperature	-25 ... 65 °C
Power Supply / Current consumption	12 ... 30 Vdc / 40 mA @ 12 Vdc
Data acquisition interval from sensors	Programmable from 1 to 60 seconds
Data logging interval	Programmable from 2 seconds to 24 hours
Storage capacity	4 MB internal memory SD memory card reader up to 8 GB
Number of samples that can be stored	The storage of a record consisting of N values requires (4 x N) bytes of memory plus 6 bytes for the date and time.
Analog inputs	16 channels; each channel can be used as a single-ended input or alternatively 2 adjacent channels can be used as a differential input. Measurement ranges: ±25 mV, ±100 mV, ±1000 mV, ±2500 mV Resolution: 16 bit, Accuracy: 0.01% f.s. Input impedance: 100 Mohm
Digital input/output ports (I/O)	8 ports, each configurable as an input for connecting a sensor or alarm output. TTL logic levels (0⇒Vin<0.8 V, 1⇒Vin>3 V) Max. input voltage: 5.5 V
Inputs for high frequency pulse counting	2 inputs Frequency of pulses 100 kHz max. TTL logic levels (0⇒Vin<0.8 V, 1⇒Vin>3 V) Minimum pulse duration 10 µs
Inputs for number of potential-free contact opening/closing counting	2 insulated inputs Switch frequency 50 Hz max. Minimum opening or closing time 10 ms
RS485 port	1 RS485 port for connection of anemometers HD2003 and HD52.3D... series, and sensors with MODBUS-RTU or proprietary protocol. Max 16 sensors. Allows connecting another HD32MT.1 data logger (in "Modbus Slave" mode) to expand the number of inputs.
RS232 ports	2 RS232 ports for connection to PC or to optional external modules. Sub-D 9-pole male connectors.
Alarm outputs	2 insulated voltage-free contact outputs Contact: max. 1 A @ 30 Vdc resistive load You can configure the single digital I/O ports as alarm outputs
Auxiliary supply outputs	+5V regulated, max. 500 mA +Vsw (switched): with same value of the power input, it is active only during acquisition of measurements

3 DESCRIPTION OF TERMINAL BOARD

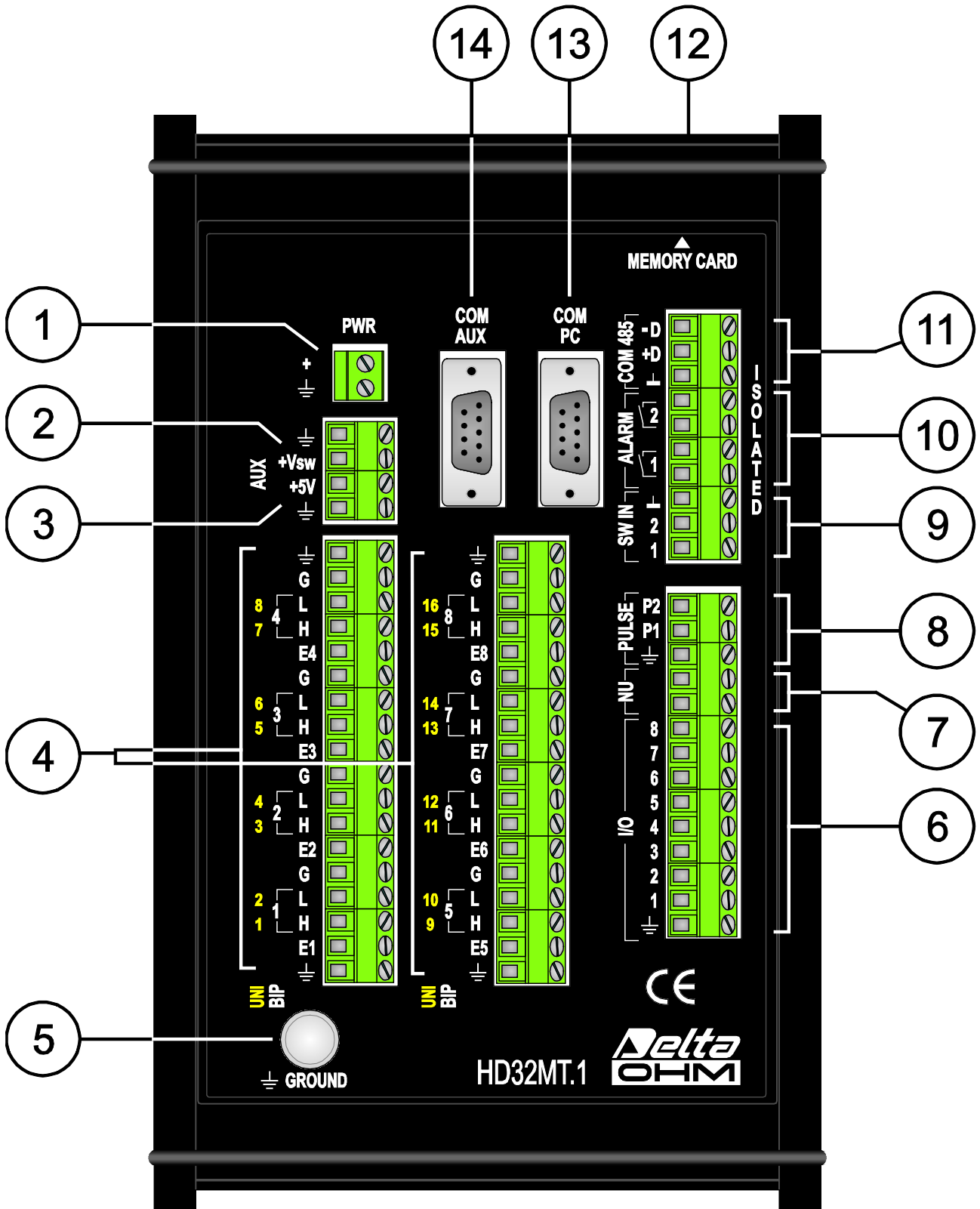

1. Power input **PWR** 12...30 Vdc.
2. Switched power supply output **+Vsw**. With the same value of the power input, but **active only during acquisition of measurements**.
3. Regulated power supply output **+5V**.
4. Inputs for analog signals. 16 single-ended inputs (**UNI** channels, the channel number is shown in yellow to the left of the terminals) are available. Alternatively, 2 adjacent channels can be used as a differential input (**BIP** channels, the channel number is shown in white to the left of the terminals).

Analog inputs terminals:

Terminal **E^(*)**: Excitation voltage. Used only in certain measurement configurations.

Terminal **H**: Positive of the input signal (both for single-ended and differential inputs).

Terminal **L**: If used as single-ended input, it corresponds to the positive of the input signal. If used as differential input, it corresponds to the negative of the input signal.

Terminal **G**: Analog ground. It has the same potential of the power supply ground. For single-ended inputs, it corresponds to the negative of the input signal.

5. Terminal for ground protection.
6. Digital input/output channels. 8 channels are available, each one usable as input for connection of sensors with ON/OFF digital output, or as alarm outputs.
7. Not used.
8. **PULSE** inputs for high frequency pulse counting Two inputs are available, marked with P1 and P2.
9. Insulated inputs **SW IN** for number of voltage-free contacts opening/closing count. Two inputs are available, marked with 1 and 2.
10. Voltage-free contact alarm outputs. Two outputs are available, marked with 1 and 2.
11. RS485 serial port for the connection of anemometers series HD2003 and HD52.3D..., and sensors with MODBUS-RTU or proprietary protocol. Allows connecting another HD32MT.1 data logger (in "Modbus Slave" mode) to expand the number of inputs.
12. Memory card reader.
13. RS232 serial port **COM PC**, for direct connection to the PC or for connection of an **optional** module (except the GSM/UMTS module).
14. RS232 serial port **COM AUX** for connection of the **optional** GSM/UMTS module.

(*) The letter **E** is followed by the channel number (E1, E2, E3, etc.). For simplicity, in this manual we are only using the letter **E** to indicate the excitation of a generic terminal channel. The actual number of the terminal to be used will be indicated by the wiring diagram depending on the required connection.

4 INSTALLATION

The commissioning of the data logger differs according to the following cases:

1. The instrument is supplied pre-configured by Delta OHM according to customer specifications;
2. The instrument is supplied pre-configured by Delta OHM, but you need to make configuration changes;
3. The instrument is not configured, you must create and install the program of measures and stores.

The following are the operations that must be performed directly by the customer in the three cases to make the instrument operational.

4.1 START-UP OF AN ALREADY CONFIGURED DATA LOGGER

If the data logger is supplied with a program of measures and recordings already installed, it comes with the wiring diagram for the program installed in the instrument.

In the wiring diagram are indicated which sensors should be used and to which numbers of instrument terminals must be connected.

The instrument does not require any further configuration and it is not necessary to connect it to the PC to make it work.

The steps to setup the system are:

- **Mechanical installation**

- In case of supply of a complete system, with an already wired box, you only need to proceed with the connection to the terminals of the external sensors and the power supply.
- If the various elements and the housing box are supplied separately, you need to install the various elements inside the box:
 - Mounting of the data logger.
 - Mounting of the possible optional devices: GSM module, Radio Modem, antennas, alarm devices.
 - Mounting of the power devices: adequate backup battery, charge regulator, power supply (if mains is available), etc.

Then proceed to connect the terminals of the various elements and of the power supply.

Note: in order to mount the external sensors please refer to the sensors documentation.

- **Electrical connection of sensors and optional devices**

- For the electric connection of sensors and optional devices, please see the wiring diagram supplied with the instrument. See paragraph 5.10 on page 33 on how to read the diagram.
If in doubt, please refer to chapter 5 for more detailed information about the features of the various inputs.
- For the connection of Radio Modem, IP Modem and Ethernet module please refer to paragraph 6 on page 38.
- For the connection of the GSM module, please refer to paragraph 7 on page 43.

- **Electrical connection of power:** please refer to paragraph 5.1.

4.2 START-UP BY MODIFYING THE DATA LOGGER CONFIGURATION

If the data logger is supplied with a program of measures and recordings already installed, the instrument comes with the wiring diagram for the program installed in the instrument. In the wiring diagram are indicated which sensors should be used and to which instrument terminals must be connected.

If you want to make changes to the program installed, for example to add another sensor, or to replace one of the sensors with a sensor of another type, you must connect the data logger to the PC to change its configuration. **You can change the program of measures and recordings even if the instrument is already installed and connected electrically, but it is advisable to reprogram the data logger before connecting the sensors, because the programming software automatically assigns the terminals to which sensors must be connected, and does not allow the user to arbitrary assign sensors to certain inputs.**

The system setup is performed through the following steps:

- **Connecting the instrument to a PC** for editing and storing the program of measures installed. The modification is performed with the help of application software **HD32MTLogger**. When you finish editing, print the new wiring diagram.

See chapter 6 on page. 36 for how to connect to the PC and the chapter 8 on page 40 for how to change the program installed, for printing the wiring diagram and examples of practical changes.

Modifying the program requires an understanding of how to connect the sensors to the terminal of the instrument, it is suggested, therefore, to consult chapter 5 "Electrical connections" to know which sensors and inputs may be used.

- **Mechanical installation**

- In the case of delivery of a complete system, with an already wired box, you just proceed with the terminal connection of external sensors and power supply only.
- If the various elements and the housing box are supplied separately, you need to install the various elements inside the box:
 - Securing of the data logger.
 - Fixing any optional equipment: GSM, radio modems, antennas, alarm.
 - Fixing the power devices: battery of adequate capacity, charge controller, power supply (if the mains is available), etc.

Then proceed with the terminal connection of the various elements and of the power supply.

Note: For mounting sensors refer to the documentation of external sensors.

- **Electrical connection of sensors and optional devices**

- For the electrical connection of the sensors follow the new wiring diagram printed by the software HD32MTLogger. Please see paragraph 5.9 on page 31 for how to read the diagram.
If in doubt please refer to Chapter 5 for more detailed information about features of the various inputs.
- For the connection of Radio Modem, IP Modem and Ethernet module please refer to paragraph 6 on page 38.
- To connect the GSM module, please see paragraph 7 on page 43.

- **Electrical connection of the power supply:** please see paragraph 5.1.

4.3 DATA LOGGER INSTALLATION WITH CREATION OF THE CONFIGURATION

If the logger is supplied without a program of measures and loggings installed, you must prepare a program and install it by connecting the logger to the PC, all with the help of application software **HD32MTLogger**.

It is advisable to program the data logger prior to electrically connect the sensors, because the programming software automatically assigns the terminals to which sensors must be connected, and does not allow an arbitrary assignment of sensors to certain inputs.

The steps for the preparation of the system are:

- **Creation of the program of measures and stores for the data logger**, using the software HD32MTLogger. During this stage it is not necessary that the logger is physically connected to the PC. At the end of the phase of creation, print the wiring diagram of the sensors.

See chapter 9 on page 53 for how to create the program, printing of the wiring diagram and practical examples.

The preparation of the program requires an understanding of how to connect the sensors to the terminal of the instrument, therefore it is suggested to consult the chapter 5 on page 13 for information about the sensors and inputs that can be used.

- **Connecting the Instrument to the PC to install the program of measures and stores**, always using the software HD32MTLogger. See chapter 6 on page 36 for how to connect to PC and paragraph 9.5 on page 98 for the installation of the program in the data logger.
- **Mechanical installation**
 - In case of supply of a complete system, with an already wired box, you just proceed with terminal connection of the external sensors and of the power supply.
 - If the various elements and the housing are delivered separately, you need to install the various elements inside the box:
 - Securing the data logger.
 - Securing any optional equipment: GSM, Radio Modem, antennas, alarm devices.
 - Securing power devices: battery of adequate capacity, charge controller, power supply (if the mains is available), etc.

Then proceed with the terminal connection of the various elements and of the power supply.

Note: For fixing of external sensors refer to the documentation of the sensors.

- **Electrical connection of sensors and optional equipments**
 - For the electrical connection of the sensors follow the wiring diagram generated by the software HD32MTLogger. Please see paragraph 5.9 on page 31 for how to read the diagram.
If in doubt please refer to Chapter 5 for more detailed information about features of the various inputs.
 - For the connection of Radio Modem, IP Modem and Ethernet module please refer to paragraph 6 on page 38.
 - To connect the GSM module, please see paragraph 7 on page 43.
- **Electrical connection of the power supply:** please see paragraph 5.1.

5 ELECTRICAL CONNECTIONS

The following describes the types of inputs and outputs available in the terminal board of the instrument. For each type of input or output, the details of the connection of the various sensors are shown.

The connections to the terminals can be divided into: :

- Power supply input (paragraph 5.1 on page 14);
- Power supply output (paragraph 5.2 on page 16);
- Differential or single-ended analog inputs (paragraph 5.3 on page 17);
- ON/OFF digital inputs/outputs (paragraph 5.4 on page 26);
- Inputs for counting pulses or opening/closing of contacts (paragraph 5.5 on page 27);
- RS485 interface for connection of Delta OHM anemometers HD2003 and HD52.3D... series, and sensors with MODBUS-RTU protocol (paragraph 5.6 on page 29);
- Alarm outputs (paragraph 0 on page 30).

The chapter includes a paragraph that explains how to read the wiring diagram generated by the software program (paragraph 5.9 on page 31). The diagram should be provided by the data logger programmer or by supplier of the system in case of program pre-installed.

They are also given examples that show the connections of a complete system, in the case of a meteorological station (at paragraph 5.10 on page 32).

It is not reported in this chapter the RS232 connection, illustrated in chapter 6 on page 36.

Warning: connecting the power supply of the various sensors used, make sure not to exceed the maximum power supply voltage specified in the data sheets of sensors.

5.1 POWER SUPPLY INPUT

The instrument requires a supply voltage of 12...30 VDC.

The power supply input is located at point **1** of the terminal board figure on page 9.

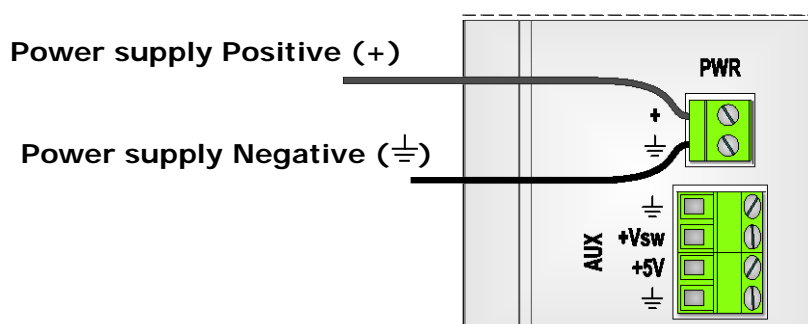

It is advisable to first connect the positive to the data logger and then the negative. By connecting the negative first is more likely to cause accidental short circuits if the free positive wire comes in contact with the many ground points on the panel.

If you use a power supply connected to the mains, in the choice of the power supply you should consider not only the internal consumption of the data logger, but also the consumption of the sensors connected to the excitation terminals of the analog inputs (terminals E) and consumption of the devices directly connected to the power supply.

If the system is installed in places where there is no mains voltage to connect a power supply, the instrument can be powered by a rechargeable standard 12 V or 24 V battery.

If the supply voltage drops below **11.7 V**, the logger goes into low power mode, interrupting the acquisition of the sensors. Normal operation will restart only when the supply voltage will rise above **12.5 V**.

Note: the supply voltage below which the logger goes into low power mode can be changed by connecting the **COM PC** port of the logger to the PC (see the paragraphs relating to the connection to the PC), and by sending, through a standard serial communication program (for example Hyperterminal), the command \$Dnnn, where nnn is the power supply value without the point. For example, \$D112 sets the value 11.2 V. The value has to be between 8.7 V and 12.7 V. Normal operation will restart only when the supply voltage will rise above the set value plus 0.8 V. The command \$E reads the set value.

In the case of battery power, it is usually also used a solar panel that keeps the battery charge. A typical power connection is as follows:

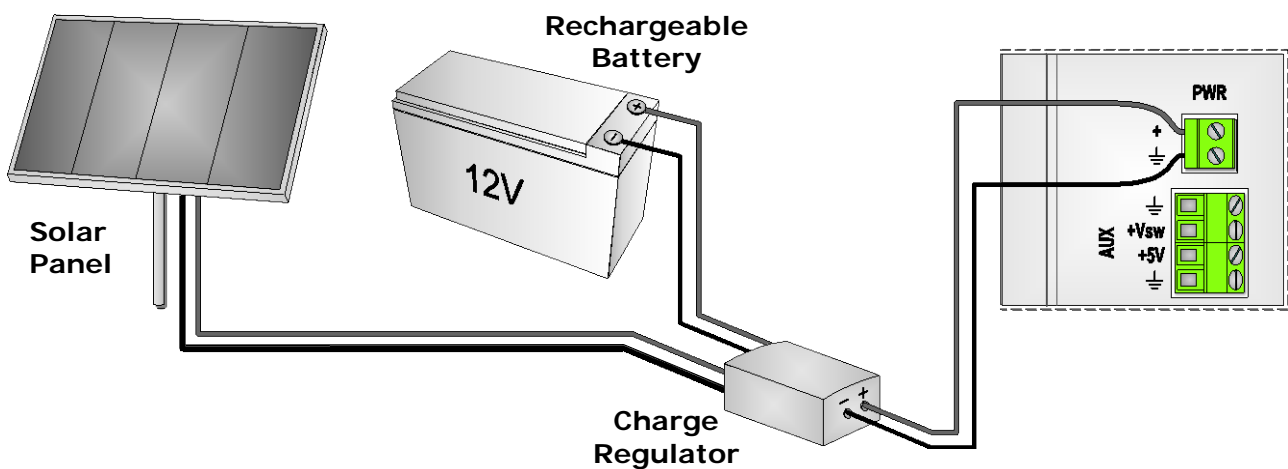

The charge regulator is essential to prevent the solar panel overcharges the battery and damages it.

The battery must have sufficient capacity to maintain power to the data logger in the periods when the solar panel can not act as a charge due to lack of sunlight. The required capacity depends on the number and type of devices connected to data logger or directly to the battery. It is recommended to provide sufficient capacity to allow the regular operation of all devices for at least a week without the solar panel generating energy.

Example

Consider a battery-powered installation in which three Delta OHM sensors are connected: an HD2003 ultrasonic anemometer, a rain detector HD2013.2 and a photometric probe LPPHOT03BLAC.

You must first consult the data sheets of the various sensors to verify the consumption:

- 110 mA for the anemometer HD2003
- 130 mA for the rain gauge HD2013.2
- 25 mA max. for the LPPHOT03BLAC photometric probe

It is assumed that the sensors are always powered.

Suppose that the system has also a Radio Modem whose consumption is 350 mA in transmission and 5 mA in stand-by mode. The average consumption of the device depends on how frequently the data transmission is requested by the remote PC. Assuming that the modem transmit for 0.5 hours a day, the average consumption during a day is:

$$\frac{0,5 \text{ h} \times 350 \text{ mA} + (24 \text{ h} - 0,5 \text{ h}) \times 5 \text{ mA}}{24 \text{ h}} = 12,2 \text{ mA}$$

In fact, the influence of the modem on the battery life is different depending on whether the transfer occurs when the solar panel is active or when the panel is not able to efficiently charge the battery (eg. particularly in cloudy days or in the evening). Assuming that the battery should last at least a day without being charged, for simplicity we can consider the average daily consumption calculated above.

Finally, we must add the consumption of the logger itself: 40 mA.

The average total consumption of the system is: $110 + 130 + 25 + 12.2 + 40 = 317.2 \text{ mA} = 0,317 \text{ A}$

The minimum capacity of the battery is obtained by multiplying the average consumption calculated by the number of desired hours of battery life, e.g. 24 h:

$$0.317 \text{ A} \times 24 \text{ h} = 7.6 \text{ Ah approx.}$$

You should not get to fully discharge the battery, and the supplied voltage must always remain above the minimum operating value. To obtain a sufficient safety margin, be sure to use a higher capacity battery than the minimum calculated (e.g. A 10Ah battery in the case referred to a day).

5.2 POWER SUPPLY OUTPUTS

The data logger provides two auxiliary outputs (AUX) through which you can power external sensors and devices. The two outputs are located under the power supply input terminals (points **2** and **3** of the terminal board figure on page 9).

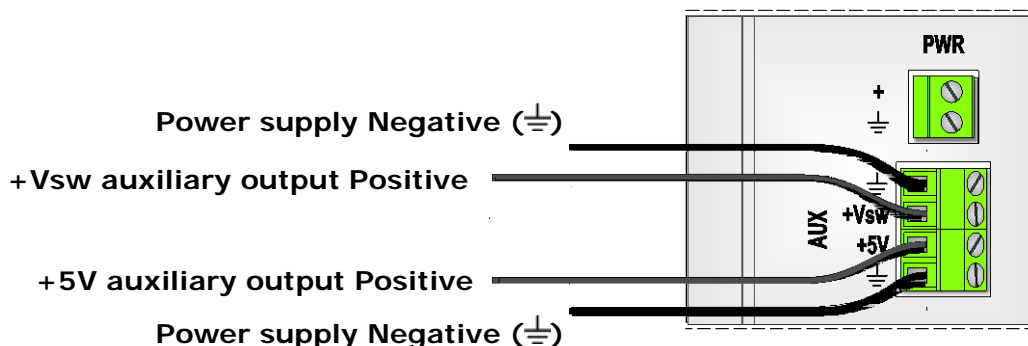

Output **+Vsw** is activated only when the logger has to acquire the measurements. During the acquisition phase, the output assumes a value equal to the power supply input. Devices connected to this output are not fed during periods of non-acquisition, thus allowing a lower average consumption of the system and a longer battery duration. The output is defined as switched type to indicate that is alternately turned on and off.

The use of the **+Vsw** output to supply a sensor must be carefully evaluated in terms of response time of the sensor. If the programmed acquisition interval of the data logger is less than the response time of a sensor, it is necessary to keep the sensor always powered by connecting it to the main power supply.

The **+5V** output is always active and is used for devices that require 5 V regulated. Output current is 500 mA max.

5.3 ANALOG INPUTS

The inputs for analog signal are shown at point **4** of the terminal board figure on page 9. The inputs can be used to measure differential mode signals or to measure signals referred to the common ground (also known as “single-ended”).

You can select four measurement ranges:

- ±25 mV
- ±100 mV
- ±1000 mV
- ±2500 mV

To different inputs can be associated different ranges. The choice of the measurement range is made while programming the data logger and depends on the type of sensors that are connected.

The analog channels are provided with a voltage output (terminal **E**(*)) used as an excitation voltage for passive sensors. The use of the terminal and the value of the output voltage depends on the type of sensor connected to the input (see the wiring diagrams of the various types of sensors illustrated in the following paragraphs). The voltage at terminal **E**(*) is present only during the acquisition phase of the measure, to minimize the consumption of the system.

The analog ground is available to terminal **G**. The analog ground has the same potential of the power supply ground.

At the ends of the two rows of terminals of the analog inputs, there are two terminals connected to the power supply ground (\perp), useful to connect the shield of the sensors cables.

The input terminals **H** and **L** of a channel take on a different meaning on whether the channel is programmed to operate in differential or single ended mode.

(*) The letter **E** is followed by the channel number (E1, E2, E3, etc.). For simplicity, in this manual we are only using the letter **E** to indicate the excitation terminal of a generic terminal channel. The actual number of terminals to be used will be indicated by the wiring diagram depending on the required connection.

Differential connection:

The instrument measures the difference between the voltage at terminal **H** (input +) and the voltage at terminal **L** (input -).

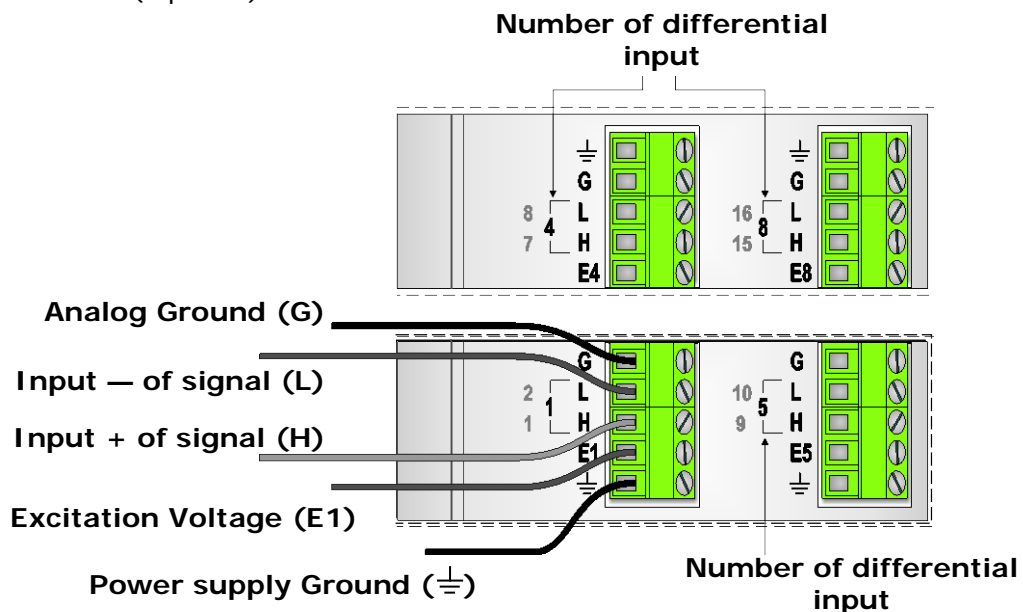

The number of the differential input is indicated by the white number that appears to the left of the terminals H and L (channels **BIP** from 1 to 8).

Single-ended connection:

The instrument measures the voltage between the terminal **H** and the analog ground **G**, and the voltage between the terminal **L** and the analog ground **G**. You can then measure two signals both relating to the common ground. The positive of one signal is connected to terminal H, the positive of the second signal is connected to terminal L.

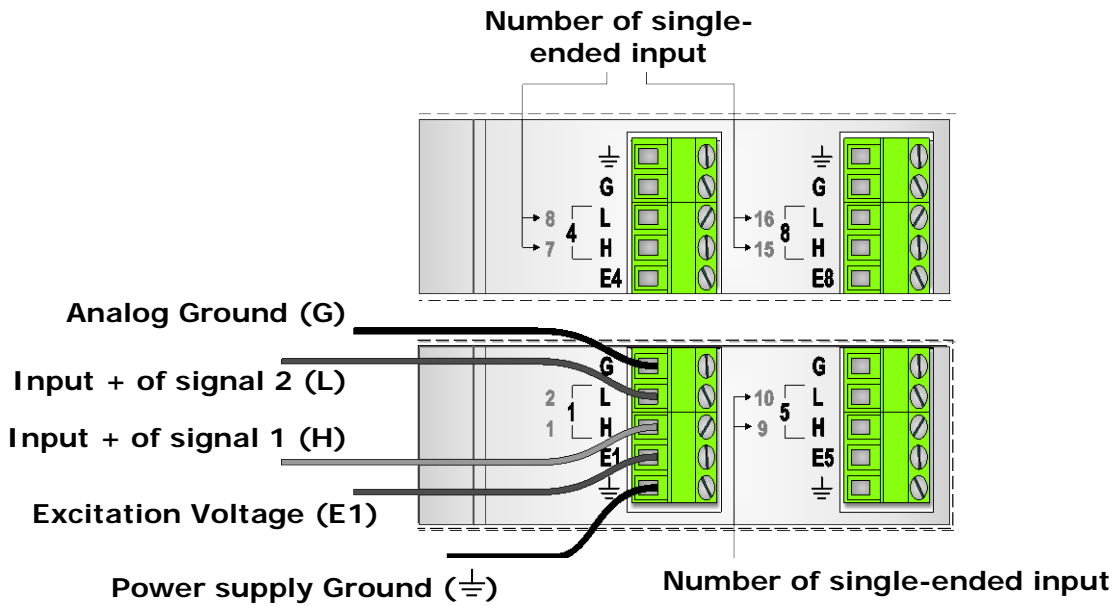

The numbers of the two single-ended inputs are indicated by the yellow numbers that appear to the left of the terminals H and L (channels **UNI** from 1 to 16).

5.3.1 CONNECTION OF SENSORS AND TRANSMITTERS WITH OUTPUT VOLTAGE

The following figure shows the connection of a generic sensor or transmitter with output voltage. The device is connected according to the differential scheme. The shield of the connection cable, if present, can be connected only on the data logger side to any terminal connected to the power supply ground (\perp).

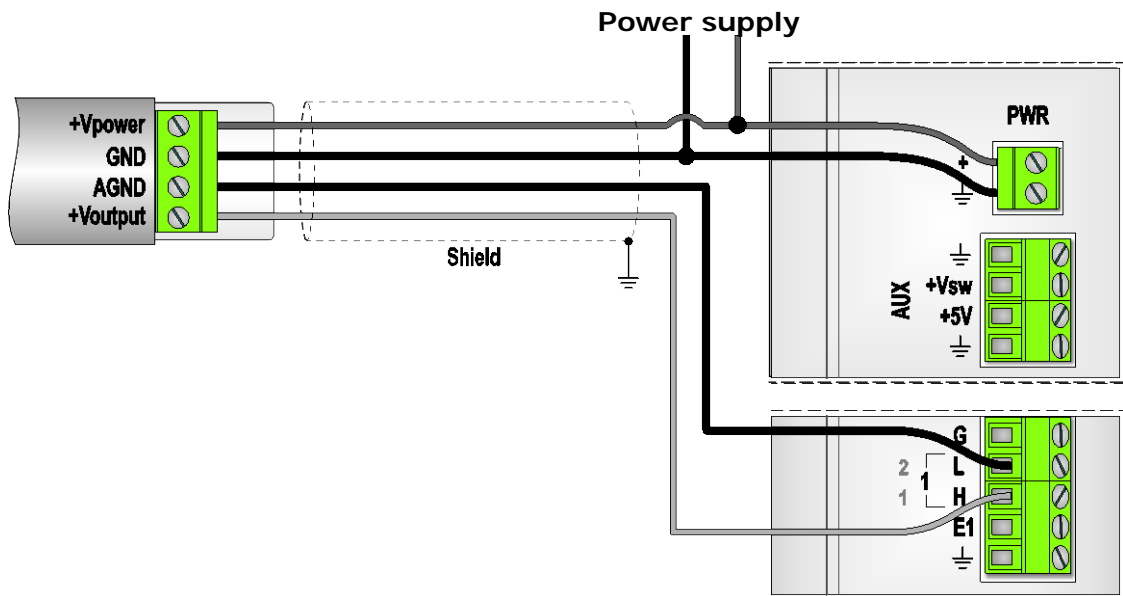

Note: the number of the input to which a sensor should be connected depends on the program installed in the data logger; for connecting the sensors follow the wiring diagram generated by the programming software, or the diagram supplied if the program is preinstalled.

If the transmitter has only one reference terminal (power supply ground coincides with the analog output signal reference), the connection scheme becomes the single-ended type as follows:

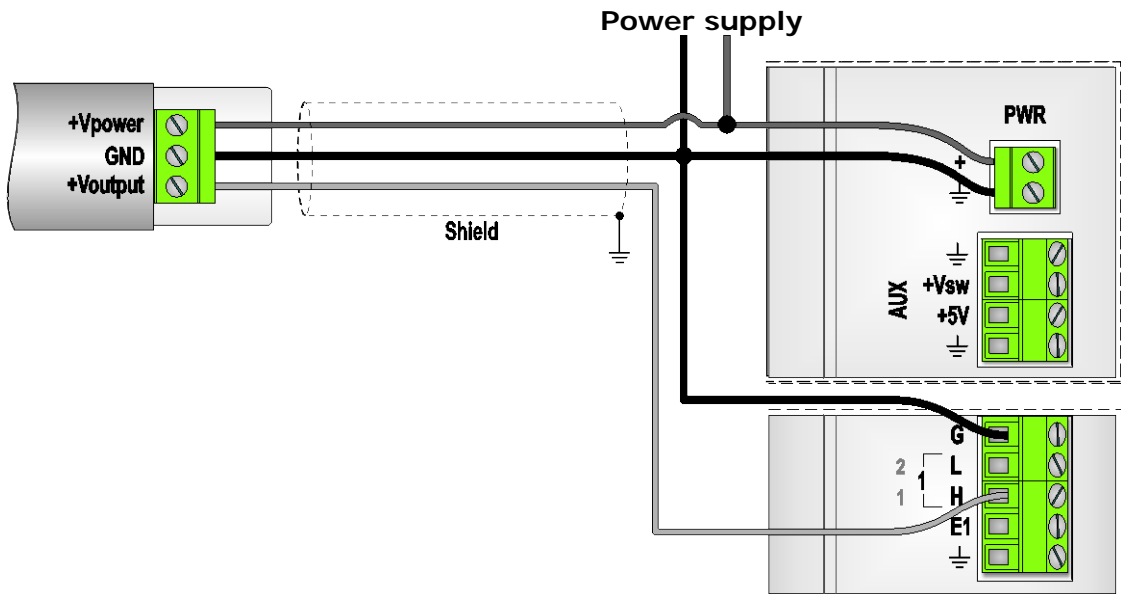

The illustration below shows, as an example, the connection of the Delta OHM HD9009TRR temperature and relative humidity double transmitter:

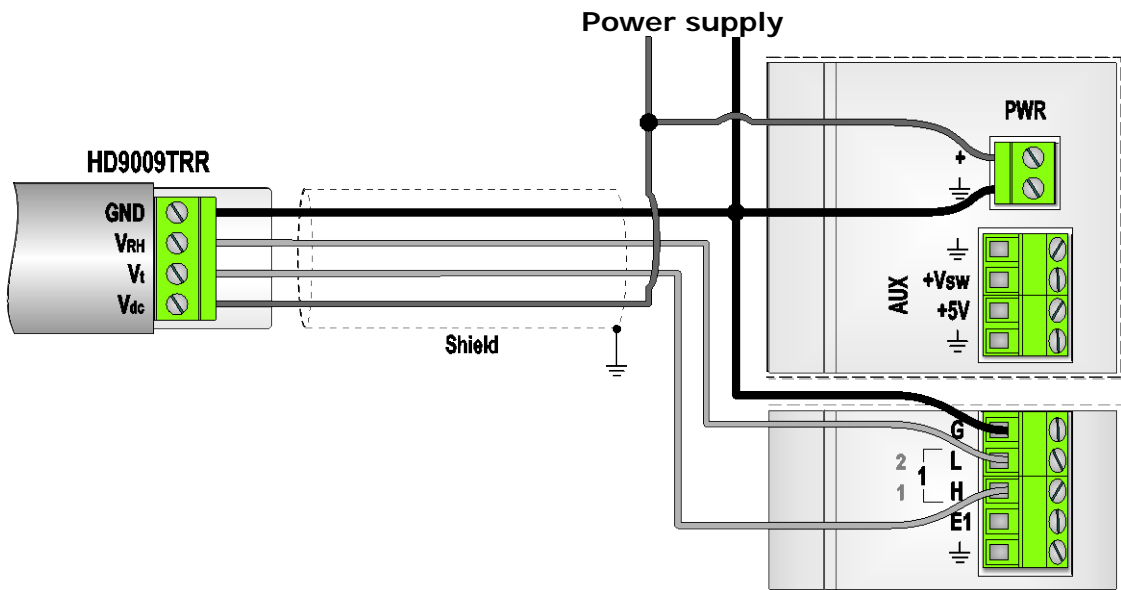

The connection scheme shown in the figures above can be used if the output device does not exceed the acceptable measurement range of the data logger. The data logger can measure signals up to 2500 mV (2.5 V).

If a transmitter provides an output signal greater than 2.5 V, it is necessary to reduce the signal by inserting a resistive divider at the input of the logger, as shown in the diagram below:

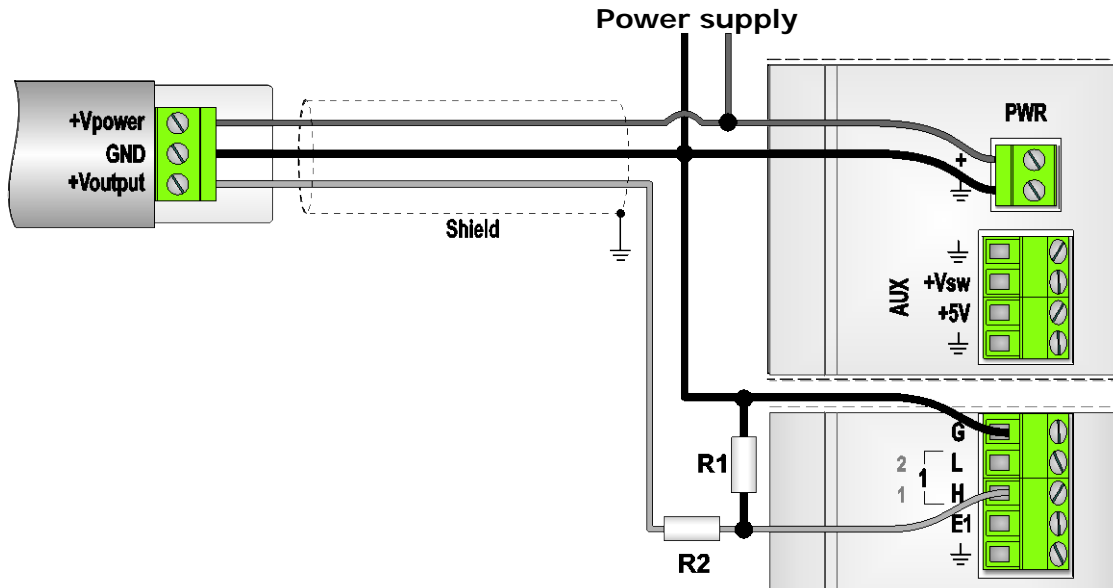

The values of R1 and R2 should satisfy the following:

$$V_{\text{transmitter full scale}} \times \frac{R1}{R1 + R2} \leq V_{\text{max datalogger}}$$

The sum of the values of R1 and R2 should be greater than the minimum value of load resistance required by the transmitter. To reduce the consumption of the system, it is still convenient to choose resistance values that are large enough. The values of the resistors should be provided by the data logger programmer, as they depend on the set measurement range.

Example

Consider a sensor with a 0...10V output and with a minimum load resistance of 10 kohm. You want to connect the transmitter to an input of the data logger with a measurement range of ± 2500 mV (± 2.5 V).

Therefore it should be: $10V \times \frac{R1}{R1 + R2} \leq 2,5V \Rightarrow \frac{R1}{R1 + R2} \leq 0,25$

Assuming you choose $R1 + R2 = 100$ kohm, the result is: $R1 = 25$ kohm and $R2 = 75$ kohm.

CONNECTION OF PROBES FOR MEASURING SOLAR IRRADIANCE WITH mV OUTPUT

An analog input can be configured specifically for the connection, both in single-ended and differential mode, of solar irradiance probes with mV output.

The probes with mV output do not require power.

If the input is programmed for single-ended connection, the connection of the probe is realized as follows:

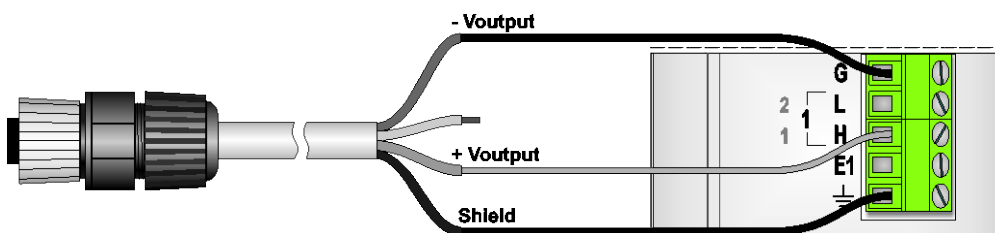

If the input is programmed for differential connection, the probe connection becomes:

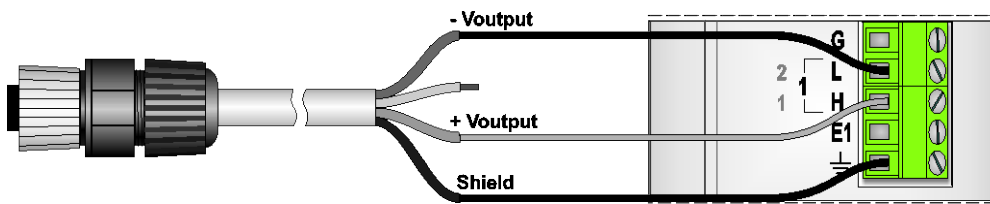

If using the differential connection, during the measurement the terminal L is internally shorted to analog ground, to ensure that the voltage inputs is within the range measured by the data logger (common mode voltage). **It is therefore advisable to use probes with a sensing element electrically isolated, to avoid reading errors due to potential differences between the ground connection point of the probe and the analog ground of the logger (grounded).** If using sensors with sensing element not isolated, to avoid reading errors it is important that the probe and data logger are grounded in the same point. If there are multiple probes connected, the terminals L of the various probes are short-circuited one at a time.

If using probes with sensing element non-isolated and occur malfunction due to the ground connection, interpose between the probe and the logger a converter / transmitter with isolated input and output. You can use the Delta OHM transmitters HD978TR3, HD978TR4, HD978TR5 and HD978TR6.

5.3.2 CONNECTING SENSORS AND TRANSMITTERS WITH CURRENT OUTPUT

To measure current signals you must first convert them into voltage through a shunt resistor.

The shunt must be a **precision resistor**, because the tolerance and temperature drift of the resistance value affects the accuracy of the measure.

The following figure shows the connection of a transmitter with generic 0...20 mA or 4...20 mA 2-wire current output ("current loop"). The data logger measures the voltage drop across the shunt resistor in differential mode.

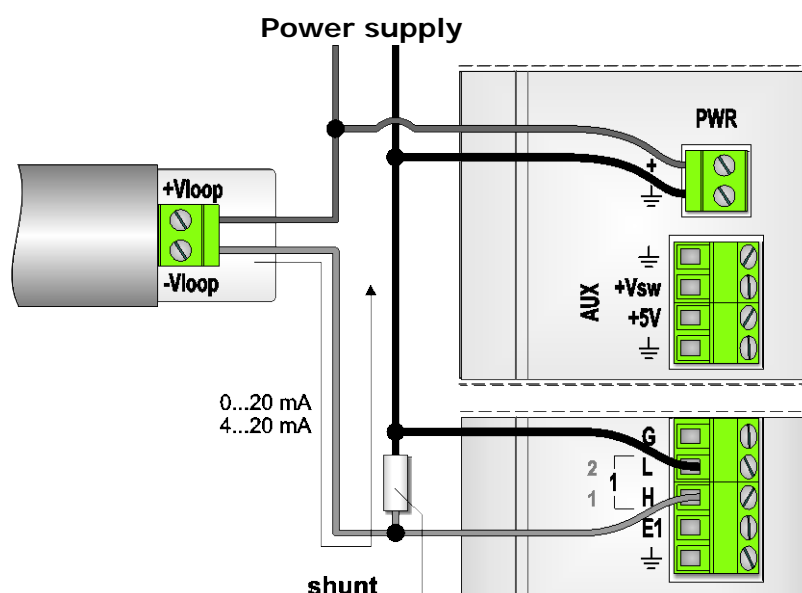

If the input of the logger is configured to measure a signal from a transmitter with current output 0...20 or 4...20 mA, connect the shunt between terminals H and L, and use a **100 ohm** shunt resistor.

If you want to use shunt resistors of different values from 100 ohm, you must program the input for the measurement of generic voltage signals, indicating the correspondence between the voltage drop on the shunt and the value of the measured quantity (see the chapter on the programming for setting mode). The shunt resistor value must be less than the maximum load resistance of the transmitter, and must be such that the voltage drop across it does not exceed the measurement range of the data logger input.

Note: the number of the input to which a sensor should be connected depends on the program installed in the data logger; for connecting the sensors follow the wiring diagram generated by the programming software, or the diagram supplied if the program is preinstalled.

When using sensors with separate connection for power supply and output signal, the connection scheme for a transmitter with active output, becomes:

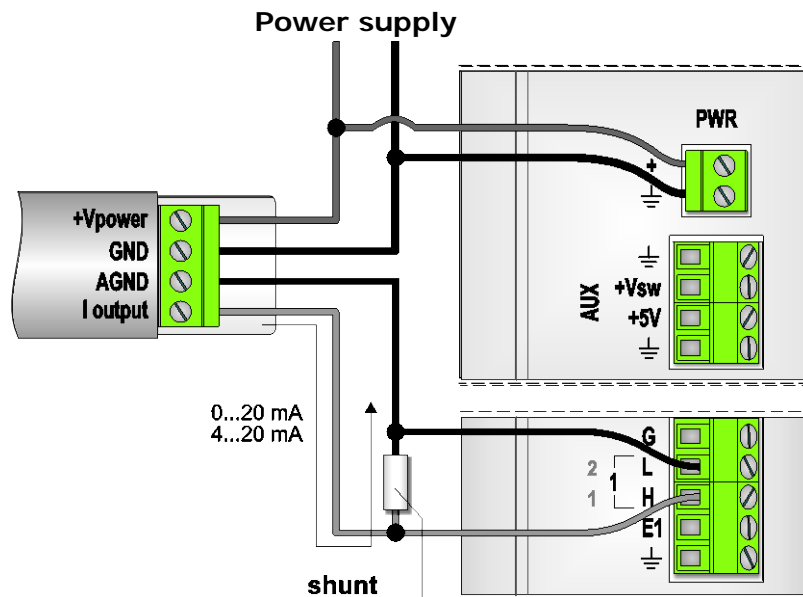

If the transmitter has only one reference terminal (ground of power supply coincides with the reference of the analog output signal), the connection scheme changes into the following:

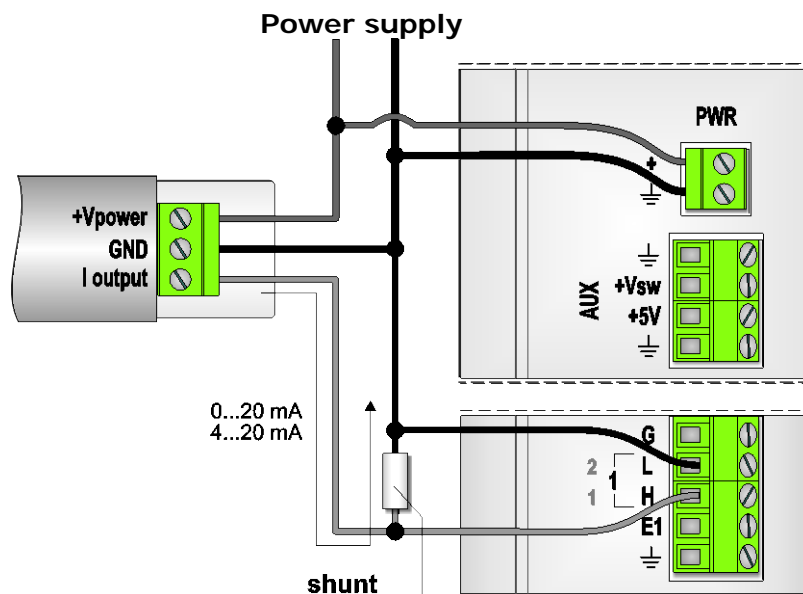

5.3.3 CONNECTION OF 2-WIRE RESISTIVE SENSORS

You can connect to the data logger resistive sensors, typically thermistor temperature probes or photoresistor, placing them in a resistive divider and measuring the voltage drop across the sensor. The wiring diagram of a probe with a resistive sensing element is as follows:

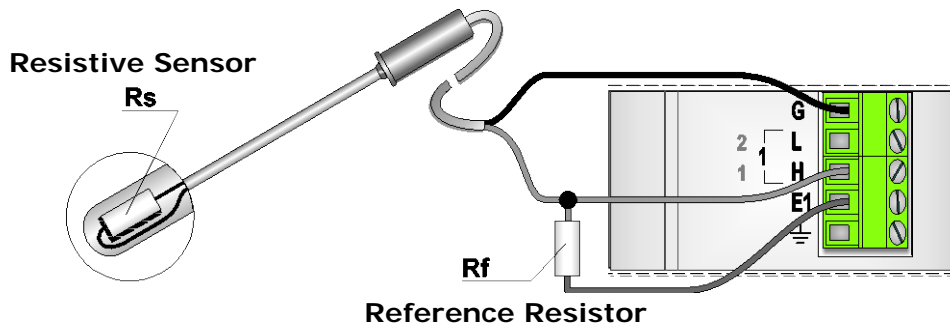

The data logger applies a voltage of 2500 mV to terminal **E**(^{*}), and measures the voltage drop across the sensor. The voltage measurement is the single-ended type (the voltage is related to the analog ground).

(^{*}) The letter **E** is followed by channel number (E1, E2, E3, etc..). For simplicity, in this manual we are only using the letter **E** to indicate the excitation terminal of a generic channel. The actual number of terminals to be used will be indicated by the wiring diagram depending on the required connection.

Any cable shield should be connected to the terminal \perp (only connect the shield on the side of the logger).

The programmable inputs for this type of measurement are only single-ended inputs UNI 1, UNI 2, UNI 3 and UNI 4.

The choice of the reference resistor R_f depends on the type of sensor connected and the type of programming of the input.

If the input is programmed specifically for the measurement of **NTC** thermistors, the resistor R_f must be equal to the value of the sensor at 25 °C. The data logger calculates the temperature according to the value of the coefficient **BETA** (β) entered during programming.

If the input is programmed to measure a general resistive divider, the data logger calculates the value of the physical quantity measured by the sensor according to the parameters written in the program, according to a linear relationship with the sensor value R_s . In this case you can choose any value for R_f , providing to respect the programming parameters. In practice it is recommended that R_f is neither too small nor too large compared to the values assumed by the sensor, otherwise the voltage change across the sensor is too small and the resolution is poor. The R_f values should be between the minimum (R_s min) and maximum (max R_s) values assumed by the sensor in the measuring range of interest.

As a rule of thumb, for the thermistors can be connected a R_f value close to the resistance of the sensor at the average temperature of the range of interest.

Note: If the data logger is already programmed, connect the R_f values provided by the programmer.

Example

Consider a NTC thermistor probe used to measure the temperature in the range 20 ... +50 °C. Suppose that the probe takes the following values:

- R_s at -20 °C = 79440 ohm
- R_s at 15 °C = 15150 ohm (medium point of the measurement range)
- R_s at 50 °C = 3893 ohm

With good approximation, for R_f you can use the standard value closer to the value of R_s at 15 °C.

5.3.4 CONNECTION OF 3-WIRE POTENTIOMETRIC SENSORS

The potentiometric output sensors are potentiometers where the cursor is mechanically connected to a mobile element. They are generally used in the detection of the position and motion of an object. Typical devices with potentiometric output are the vane sensors for wind direction (gonioanemometers).

The connection of this type of sensor is realized as follows:

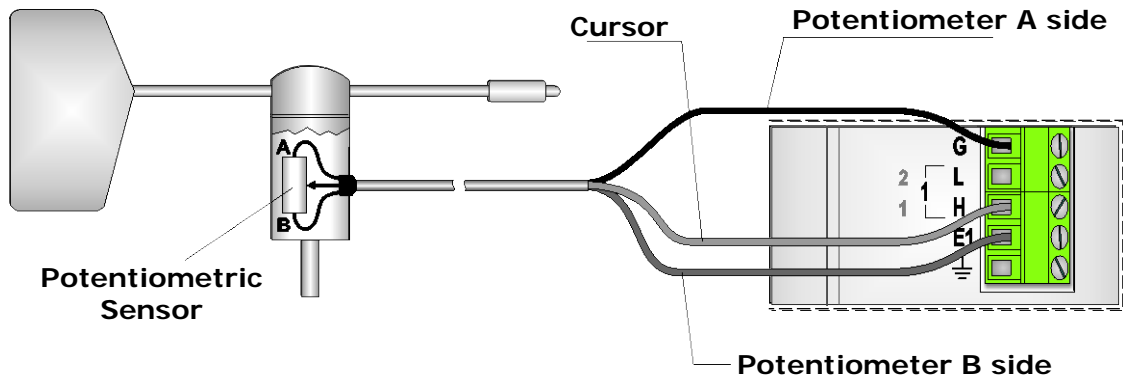

The ends of the potentiometer are connected to terminals **E**(^{*}) and **G**, while the cursor is connected to a single-ended input (the number depends on the program). The data logger applies the voltage of 2500 mV across the potentiometer, and measures the voltage on the slider with respect to the analog ground.

(^{*}) The letter **E** is followed by the channel number (E1, E2, E3, etc.). For simplicity, in this manual we are only using the letter **E** to indicate the excitation terminal of a generic channel. The actual number of terminals to be used will be indicated by the wiring diagram depending on the required connection.

With the connection shown in the figure, the measured voltage increases when the cursor moves to the end B of the potentiometer. If you want to reverse the behaviour, just exchange the connections of the two extremes of the potentiometer.

The programmable inputs for this type of measurement are only single-ended inputs UNI 1, UNI 2, UNI 3 and UNI 4.

5.3.5 CONNECTION OF 4-WIRE RESISTIVE SENSORS

The resistive sensors having low values of resistance, such as **Pt100** temperature sensors, are also available in 4-wire version to allow connection to circuits that compensate for the resistance of the wires to get a more accurate measure.

The figure below shows the connection of a 4-wire resistive sensor:

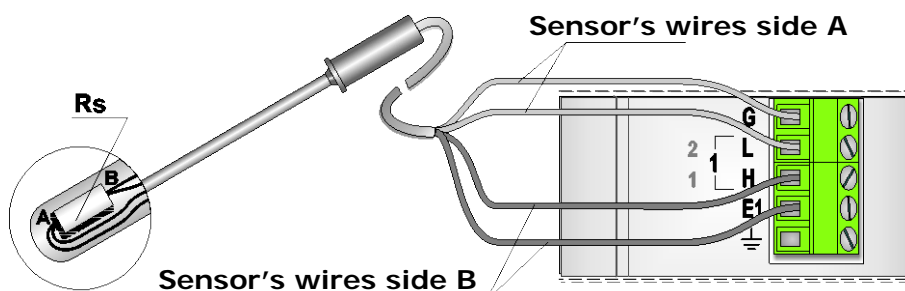

To **G** and **L** terminals are connected the two wires coming from the same side of the sensor, to terminals **H** and **E**(^{*}) are connected the two wires from the other side. The measurement of

voltage drop on the sensor is in differential mode (the channel number depends on the program).

Any cable shield should be connected to the terminal \perp (only connect the shield on the side of the logger).

In this type of measurement, to terminal **E**^(*) there is not a fixed voltage, but the measuring circuit is automatically adjusted for the correct compensation of the connecting cables. For details of the measure see the section on programming.

(*) The letter **E** is followed by the channel number (E1, E2, E3, etc.). For simplicity, in this manual are only using the letter **E** to indicate the excitation terminal of a generic channel. The actual number of terminals to be used will be indicated by the wiring diagram depending on the required connection.

If the input is programmed specifically for the measurement of Pt100 or Pt1000 sensors with coefficient $\alpha=0.00385$, the data logger provides directly the measured temperature.

If the input is programmed to measure a general resistive sensor, the data logger calculates the value of the physical quantity measured by the sensor according to a linear relationship with R_s , depending on the parameters entered in programming.

5.3.6 CONNECTION OF THERMOCOUPLES

The following figure shows the connection of a thermocouple probe:

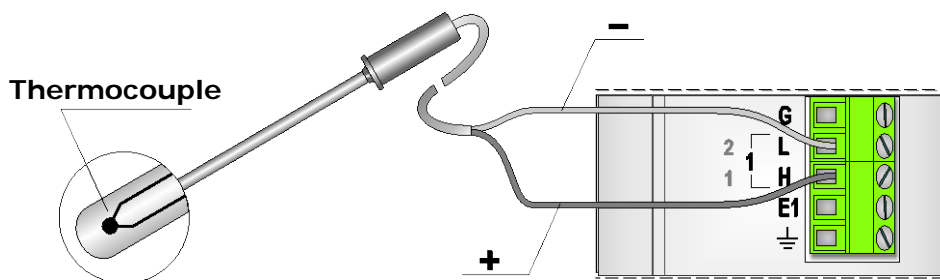

The wire correspondent to the positive of the thermocouple is connected to terminal **H**, the negative wire connects to terminal **L** (the channel number depends on the program).

The instrument automatically compensates for cold junction temperature, using an internal temperature sensor.

The input can be programmed to read thermocouple types K, J, T, N, R, S, B, E.

During the measurement, the terminal **L** is internally shorted to analog ground, to ensure that the voltage at the inputs is within the range measured by the instrument (common mode voltage). **It is therefore advisable to use electrically insulated thermocouples, to avoid reading errors due to potential differences between the measurement point and the instrument analog ground (grounded).** If the thermocouple is not isolated, to avoid reading errors it is important that the measuring point and the analog ground of the instrument have the same potential. If there are multiple thermocouples connected, the terminals L of the various thermocouples are short-circuited one at a time.

If you use non-insulated thermocouples and malfunctions occur due to the ground connection, place a converter/transmitter with isolated input and output between each probe and the data logger. In that case, input of data logger must be programmed as a current or voltage input depending on the output of the converter/transmitter, and not as a thermocouple input. You can use the Delta OHM transmitters HD978TR series. The following illustration exemplifies the use of the converter/transmitter HD978TR1 with output 4...20 mA.

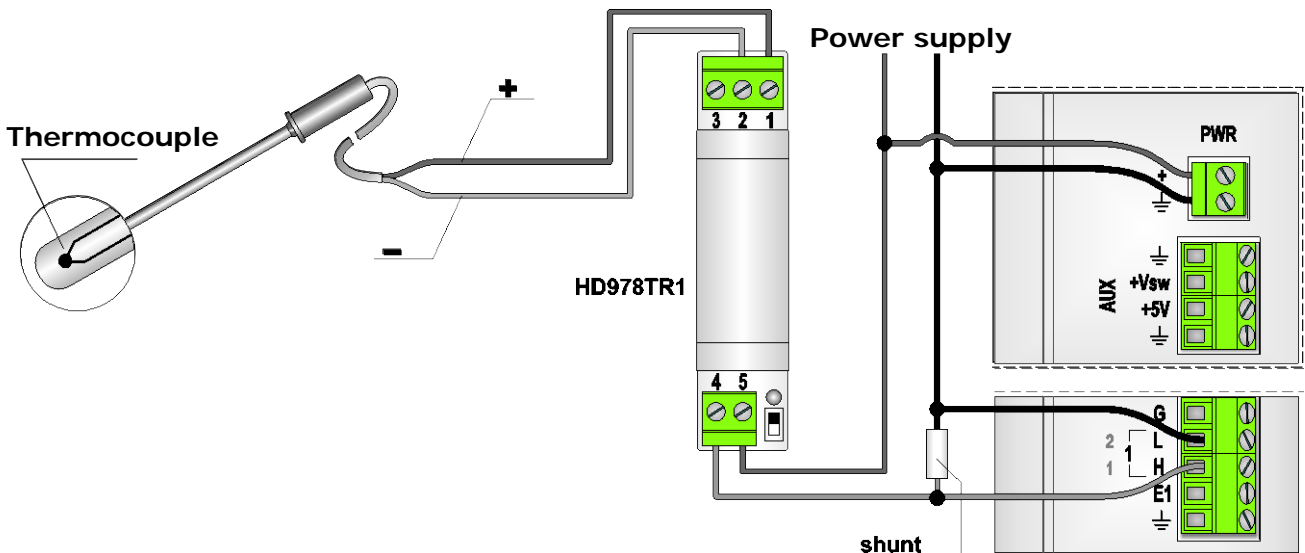

5.4 DIGITAL INPUTS AND OUTPUTS

The instrument is equipped with 8 digital input and output ports, located at point **6** of the terminal board figure on page 9.

Each port can be configured to be used as input to read the state in which the output of a digital device is in the moment of capture, or as output, to signal the occurrence of alarm conditions when the measured values exceed the thresholds programmed into the data logger.

The digital ports operate at TTL levels. Voltages values below 0.8 V are recognized as a logic 0. Voltages above 3 V are recognized as a logic 1. Digital signals are referred to the power supply ground \perp . Each input has a 100 k Ω pull-up resistor: the input is at logic level 1 when it is not controlled.

Do not apply to the inputs voltage above 5.5V to not damage them.

The inputs are not suitable for counting of pulse, for which the Pulse inputs are provided.

The following figure shows, as an example, the connection to the port 1 (configured as an input) of a sensor with a digital output, and the connection to the port 2 (configured as an alarm output) of a device with digital input to process the alarm signal.

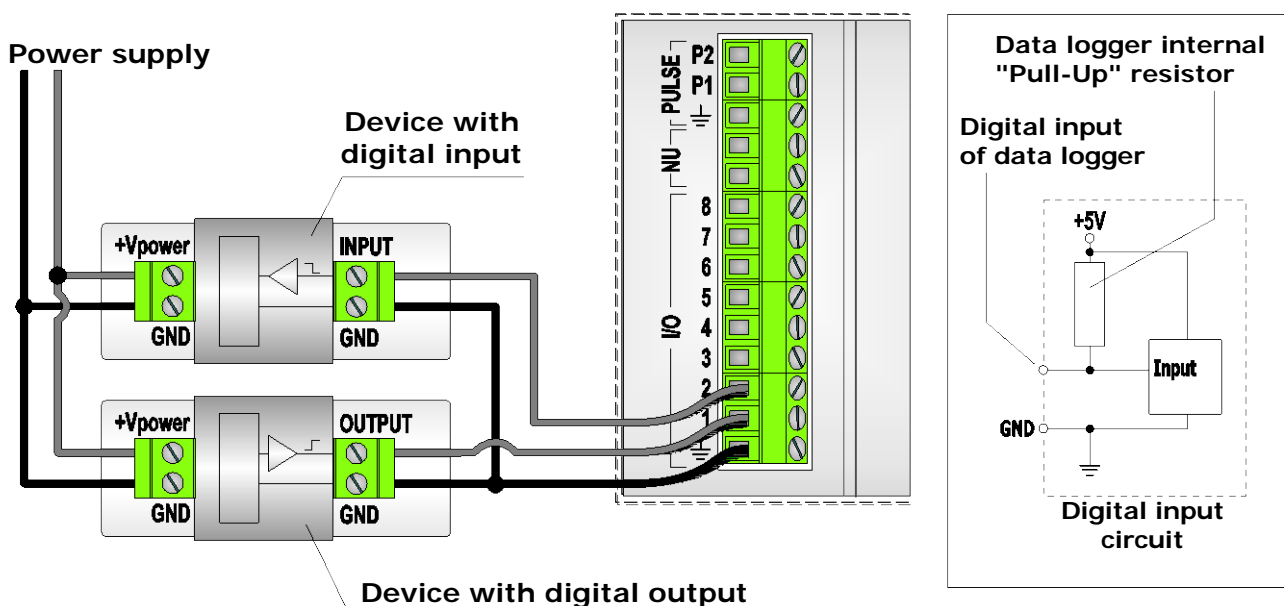

5.5 INPUTS FOR PULSE COUNTING

For the detection of pulse signals there are two types of inputs:

- Inputs for counting high frequency pulses
- Inputs for counting the number of opening/closing of voltage-free contacts.

5.5.1 HIGH FREQUENCY PULSE COUNTING

To count digital pulses up to 100 KHz are used **PULSE** inputs, located at point **8** of the terminal board figure on page 9.

There are two inputs: **P1** and **P2**. The signals are referred to the power supply ground \perp .

Typical sensors that can be connected to this type of input are cup anemometers with frequency digital output.

The connection is realized according to the following scheme:

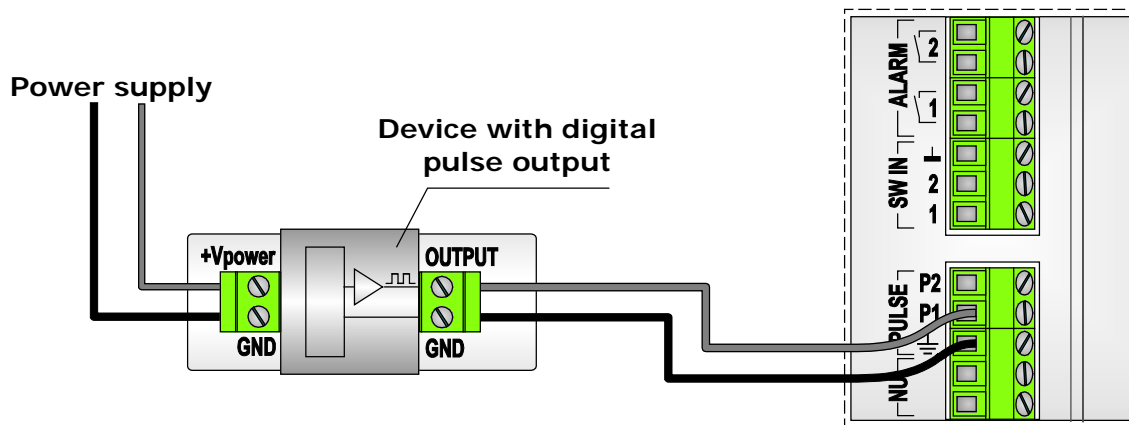

The inputs work at TTL levels. Voltage values lower than 0.8 V are recognized as logical values 0. Voltage values higher than 3 V are recognized as logical values 1.

Do not apply to the inputs voltage above 5.5 V to prevent damage the inputs themselves.

To be detectable, the pulses must have a minimum duration of 10 μ s.

5.5.2 COUNTING NUMBER OF OPENING/CLOSING OF VOLTAGE-FREE CONTACTS

To count the number of openings and closings of a voltage-free contact, for example the contact of a relay, there are two **SW IN** inputs, located at point **9** of the terminal board figure on page 9.

The inputs are **insulated** and identify the switching of a contact to the maximum frequency of 50Hz. In order for the contact switching to be detected, the contact must be closed or open for at least 10 ms.

Typical sensors that can be connected to this type of input are the cup anemometers with contact output and the tipping bucket rain gauges.

The following shows the connection of a device with contact output:

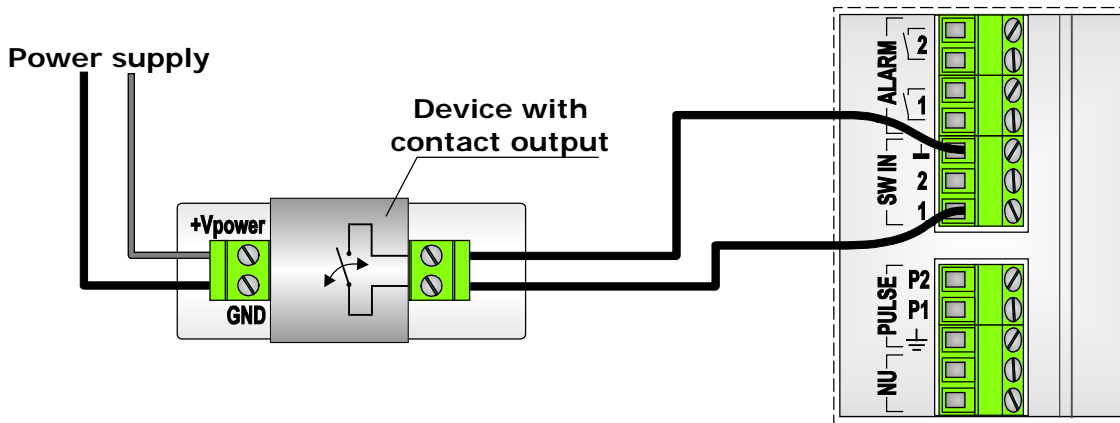

The following example describes the use of the Delta OHM sensor HD2013 connected to the input 1 and of a cup anemometer connected to input 2. It is assumed that the two sensors are completely mechanical and does not need power.

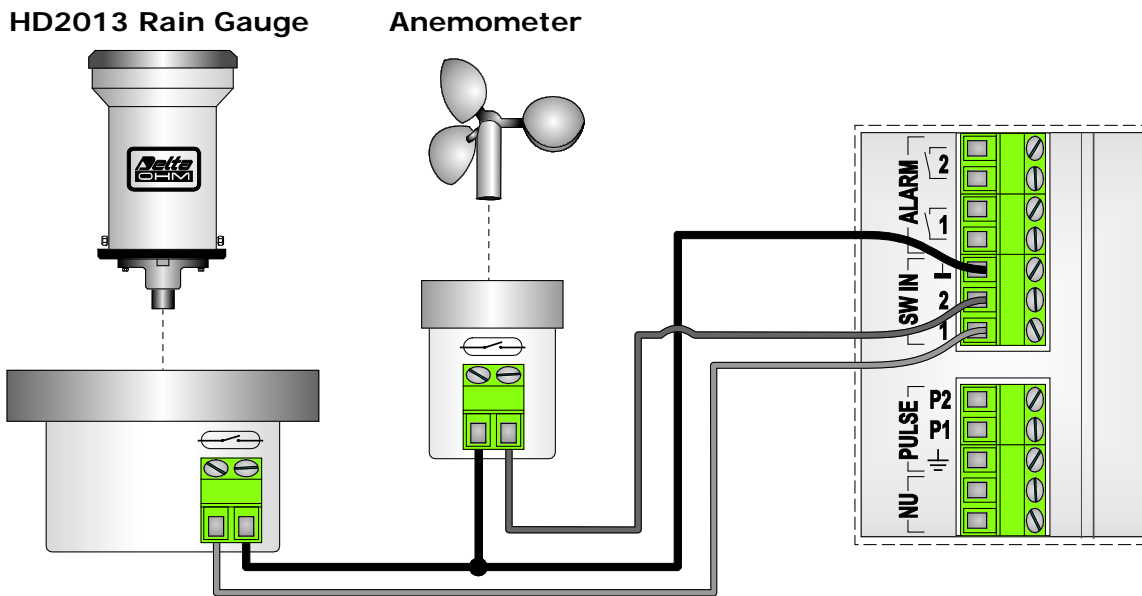

5.6 RS485 CONNECTION

The RS485 communications port (**COM 485**) of the logger is set to work with ultrasonic anemometers Delta Ohm HD2003 and HD52.3D... series, and with sensors with MODBUS-RTU or proprietary protocol. Max 16 sensors can be connected.

The **COM 485** port is located at point 11 of the terminal board figure on page. 8. The connection of the anemometer or sensor is as follows:

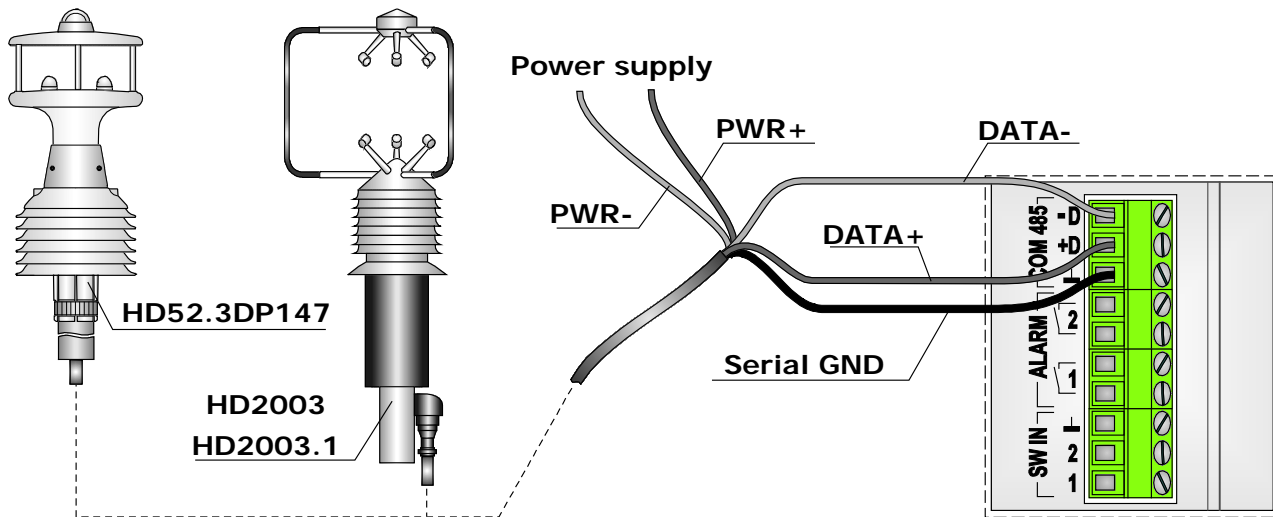

The **DATA+** terminal of the anemometer or sensor is connected to the **+D** input of the data logger. The **DATA-** terminal of the anemometer or sensor is connected to the **-D** input of the data logger. The anemometer or sensor serial ground is connected to the terminal indicated by the symbol \perp , corresponding to the insulated ground of the RS485 circuit.

If you use an anemometer with heating option, it is suggested to connect the anemometer power supply to the main power supply of the system, so as to keep always on the heating function.

Note: if the cable is very long, you should put on the RS485 data lines DATA+ and DATA- a surge protection device.

For the proper functioning of the system, the anemometers and the sensors must be pre-configured with the following settings:

1. The order in which the anemometer or the sensor sends the measured values to the output must match the one programmed into the data logger.
2. The units of measurement set in the anemometer or in the sensor should match the ones programmed in the datalogger.
3. Averaging period of the measures = 1 second (for Delta OHM anemometers only).
4. RS485 communication mode.
5. The RS485 Address must match the one programmed into the data logger.
6. Baud Rate = 115200 for the Delta OHM anemometers. For the other sensors, the communication speed must match the one programmed into the data logger.

In case of supply of a complete system with anemometer and data logger with program pre-installed, the anemometer is already configured as required by the program and you do not need to perform any preset. Otherwise, please refer to the chapter of the manual on programming of the logger and anemometer manual for how to set parameters.

RS485 connection via optical fiber:

The sensors with RS485 output can be connected to the data logger via optical fiber by using the optional external HDTCF-142-M module.

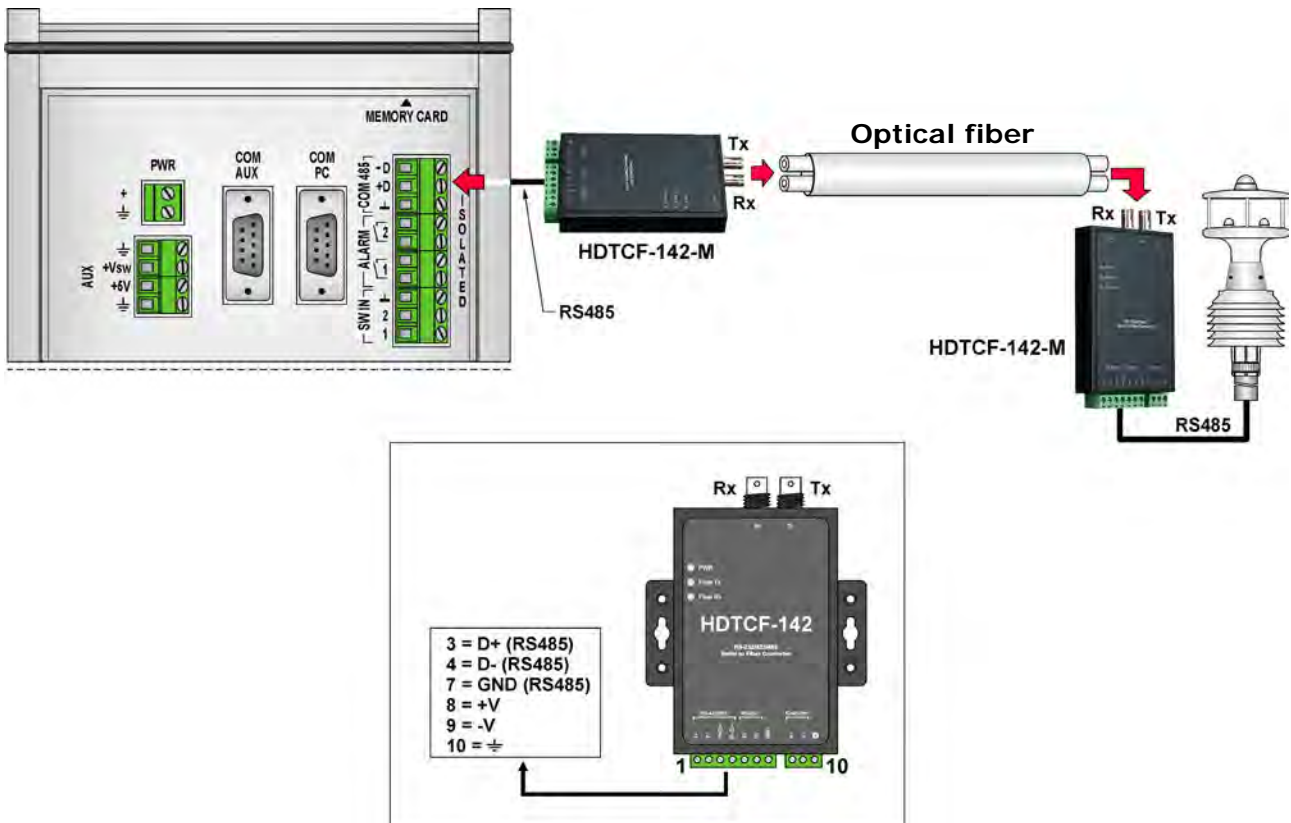

5.7 EXTENDING THE NUMBER OF INPUTS

To increase the number of inputs available, two (or more) data loggers can be used, by connecting the COM PC port of a HD32MT.1 data logger, configured as “Modbus-RTU Slave” unit, to the RS485 port (through a RS232 / RS485 converter, for example **HD7520R**) of a second HD32MT.1 data logger, which will operate as “Modbus-RTU Master” unit for the first data logger.

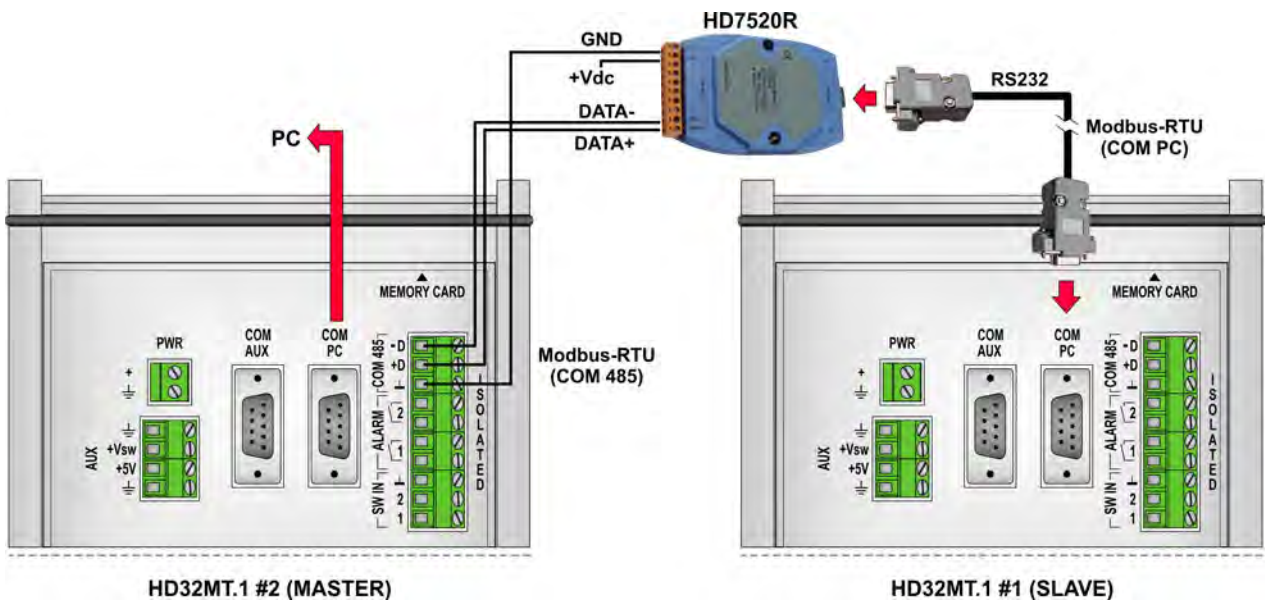

Connect a standard RS232 serial cable between the data logger #1 **COM PC** port and the HD7520R adapter RS232 serial port. The cable has female connector on the side of the instrument and male connector on the side of the adapter. The connectors are 9-pin Sub-D type. The length of the cable must not exceed 15 meters.

To set the data logger #1 as “Modbus Slave” unit with **Modbus-RTU** protocol, see chapter 10.

5.8 ALARM OUTPUTS

The data logger has alarm outputs that are activated when the acquired values exceed the programmed thresholds or sensors or data logger failures occur.

You can configure one or more ports of I/O to work as alarm outputs (see section 5.4 on page 25 for the connection of such ports), or you can use the two outputs with potential-free contact indicated at point [10] of the terminal board figure on page 8.

If a I/O port is configured as alarm output, the output changes to logic level 1 when the alarm condition occurs. The output returns to logic 0 if the measure falls within the programmed thresholds.

If you use an output with potential-free contact, contact is normally open and closes when the alarm condition occurs. The contact remains closed until the alarm condition persists.

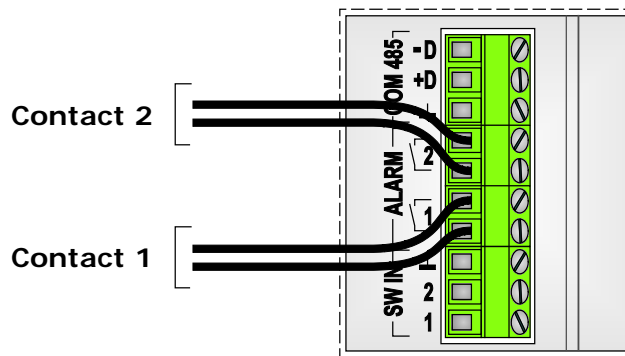

While connecting the outputs to external devices, make sure not to exceed the specifications of the electrical contact (1 A – 30 Vdc resistive load).

5.9 GROUNDING

The instrument is provided with a terminal for connection to protective earth. The terminal is indicated by point [5] of the figure of the terminal on page 8.

To connect the cable, unscrew the knob of the clamp, insert the lug of the cable and then replace the knob ensuring secure clamping of the cable.

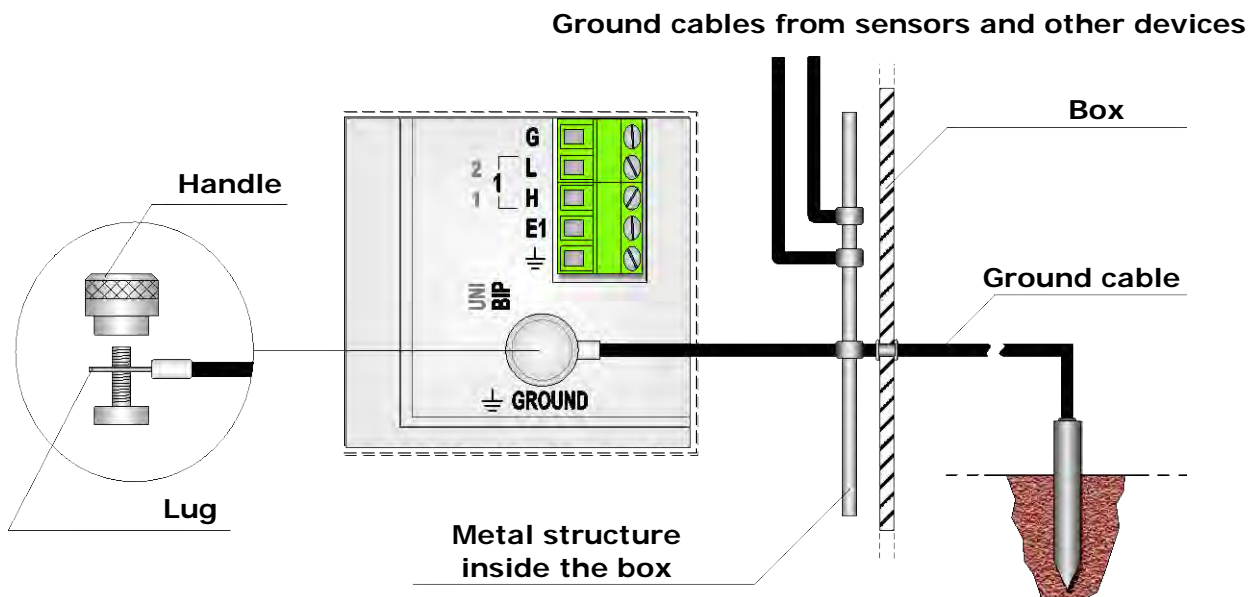

For the ground connection use a cable size of at least 12 AWG (=3.31 mm²).

The ground terminal is at the same potential of the power supply ground and of the analog ground reference.

It is recommended that in the system there is only one connection point to the ground, to avoid currents generated by several points at different potentials (ground loop) that may cause measurement errors. If the sensors connected to instrument shall provide its own ground connection, connect to a common metal bar inside the system container and then connect the bar to the ground. If the container is metal, the bar must also be connected to the container.

THE PROBLEM OF DIFFERENT GROUND POTENTIALS (GROUND LOOP)

Different ground points could not be exactly at the same potential. If the housing of a sensor is connected to the ground and the sensing element is not electrically insulated from the housing, it can generate unwanted currents flowing in the cables of the signal when the sensor is connected to a receiver (ex. a data logger) also grounded in a different place.

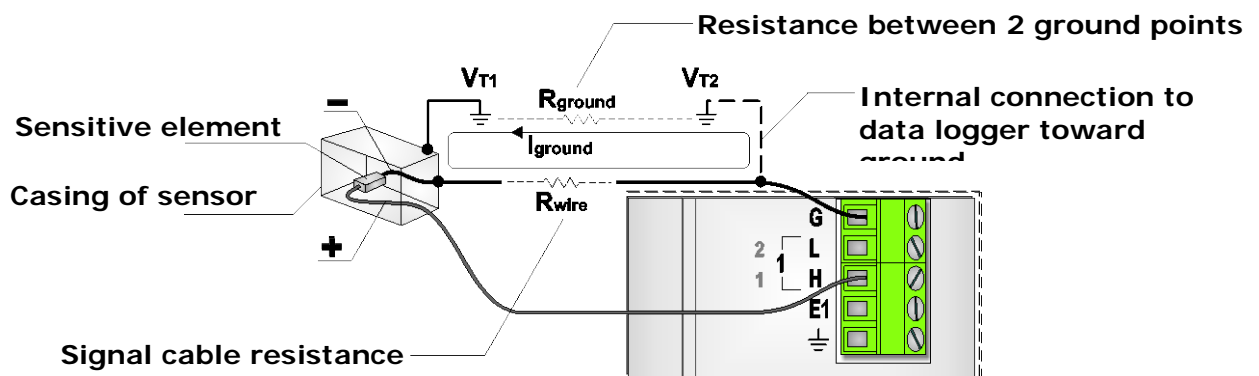

In this situation there is a measurement error due to the fact that the logger detects the output signal of the sensor summed with the difference of the two ground potentials.

The problem is particularly relevant in the case of sensors that have a very small output signal, for example, thermocouple probes (if the hot junction is connected to the outer sheath) or solar probes with output in mV (if the negative signal is connected to the metallic housing).

In the case of inputs configured for the measurement of thermocouples and solar radiation sensors with mV output, the problem occurs even if the measure is in differential mode (the negative signal is connected to L instead of G) because the data logger internally connects the input L to ground during the measurement.

In general, you can avoid the drawbacks due to the "ground loop" effect by observing the following rules:

- Connect all the sensors and data logger to a single ground point.
- Connect the cable shield only by the data logger and leave it free on the probe side.
- Placed between the sensors and data logger converters / transmitters with isolation between input and output
- Do, when possible, truly differential measurements, in which the negative is high impedance and therefore has no physical connection to analog ground.

5.10 HOW TO READ THE WIRING DIAGRAM

The connection of the sensors must be made in accordance with the program installed in the data logger. The **HD32MTLogger** programming software is designed to generate a list of connections required by the program. It is the responsibility of the data logger programmer to create a wiring diagram of the data logger connections required to be provided to the installer.

The wiring diagram generated by the programming software has the following form:

HD32MT.1 Wiring Diagram		Scan Period: 2 sec				Program: My_System	
Measure Data	#	Name	Unit	Channel	Wiring	Info	
1 NTC beta=3579.0	b	Sensor_01	deg C	UNI1	[NTC-> closest by H to G] [Reference Rf-> closest by H to E]	1/3/333.333/0.12/0/0	
2 Ratio of Voltages Vs/VExc	c	Sensor_02	degrees	UNI2	[+Vs-> L] [+VExc-> E] [-Vs and -VExc-> G]	2/3/0.0/0.1/0/0	
3 Thermocouples K	f	Sensor_03	deg C	BIP2	[+Signal-> H+E] [-Signal-> L]	3/4/0.0/0.144/1/0	
4 Resistance Divider 4Wire	g	Sensor_04	deg F	BIP3	[wire #1-> E wire #2->H] [wire #3-> L wire #4-> G]	4/3/2866.666/0.3/0/0	
5 Unipolar Voltage	h	Sensor_05	%RH	UNI7	[Signal-> H] [Ground-> G]	3/0/0.0/100.0/10.0/0	
6 Bipolar Voltage	i	Sensor_06	mbar	BIP5	[+Signal-> H] [-Signal-> L]	4/0/0.0/100.0/10.0/0	
7 Current Loop 4-20mA	j	Sensor_07	ppm	BIP6	[Shunt closest by H to L] [-mA-> H] [+mA-> +PWR] [L-> GROUND]	1/0/0.0/0.2/2/0.200	
8 Digital Pulses	k	Sensor_08	mm	PULSE 1	[Signal-> PULSE P1] [Ground-> GROUND]	2/0/0.0/1.0/2/0	
9 Switch Closure	l	Sensor_09	m/s	SW IN 1	[Signal-> SW IN 1] [Ground-> ISOLTED ground]	1/0/0.0/0.2/2/0.200	
10 Radiometry	m	Sensor_10	W/m2	BIP7	[+Signal-> H] [-Signal-> L]	2/0/0.0/1.0/2/0	
11 HD2003 SpeedWind	n	Air_Speed	m/s	COM 485	[DATA+ -> D+] [DATA- -> D-] [Ground-> ISOLATED ground]	2/5/0.0/1.0/M1xx/1	
12 HD2003 Direction	o	Direction	degrees				
13 HD2003 Pressure	p	Pressure	mbar				
14 HD2003 Temperature	q	Temperature	deg C				
15 HD2003 R. Humidity	r	RH	%				
16 free	---	---	---				
17 free	---	---	---				
18 free	---	---	---				
19 free	---	---	---				
20 free	---	---	---				

The diagram consists of a head which shows the name of the program and the acquisition interval, and a series of columns describing the sensors provided:

1. Sequential number of the sensor.
2. Description of the sensor output.
3. Letter designating the sensor: the information is assigned automatically by the program and can be neglected with regard to the connection.
4. Sensor name: identifies the sensor to be connected.
5. The unit of measurement of the quantity measured by the sensor.
6. Input of the logger to which the sensor must be connected.
7. Details of the connection to be made. Information on the connection described in detail in the previous paragraphs are reported in mnemonic form.
8. Summary information about programming parameters. In some cases, the column can not be present if there is not enough space to print.
9. Name of the program.
10. Acquisition interval (Scan Period).

The columns to be considered for installation are the **4** (which sensor must be installed), **6** (which input should be connected to the sensor) and **7** (connection details).

Note: The connection diagram does not include the values of possible resistors to be connected externally to the data logger, such as shunt resistors, the resistors of the divider to attenuate the signals or the reference resistors of NTC. Values must be supplied separately by the programmer.

5.11 EXAMPLES OF METEOROLOGICAL STATIONS

Here are two examples that illustrate the connection of several sensors that are used routinely in a weather station.

The examples show two possible solutions to measure the following parameters: temperature, humidity, barometric pressure, wind speed and direction, amount of rainfall, global and net solar radiation.

It is assumed that the stations are powered by a battery connected to a solar panel.

In the figures the choice of inputs to which sensors are connected is only an example. In a real installation adhere to the wiring diagram supplied by the programming software of the data logger.

Example 1

Consider a weather station that requires the installation of the following sensors:

- **HD9009TRR temperature and relative humidity transmitter with output 0-1 V**
temperature output connected to the single-ended analog input number 1
relative humidity output connected to the single-ended analog input number 2
- **Vane sensor for wind direction with potentiometer output**
cursor of the potentiometer connected to the single-ended analog input number 3
potentiometer extremes connected to terminals E2 (excitation) and G (analog ground)
- **HD9408TR BARO barometric transmitter with output 0-1 V**
pressure output connected to the single-ended analog input number 4
- **LP NET 07 Net radiometer with mV output**
connected to the differential analog input number 3
- **LP PYRA 02 Pyranometer with mV output**
connected to the differential analog input number 4
- **HD2013 tipping bucket rain gauge**
connected to the SW IN number 1 input
- **Cup anemometer with contact output**
connected to the SW IN number 2 input

The sensors that require power (HD9009TRR and HD9408TR BARO) are connected to the main power supply of the system.

The connection diagram provided by the software program takes the following form:

Sensors to be connected			Inputs of data logger		Connections to be performed	
HD32MT.1 Wiring Diagram						
	Measure Data	#	Name	Unit	Channel	Wiring
1	Unipolar Voltage	a	HD9009TRR_T	Degree C	UNI1	[Signal-> H] [Ground-> G]
2	Unipolar Voltage	b	HD9009TRR_RH	%RH	UNI2	[Signal-> H] [Ground-> G]
3	Ratio of Voltages Vs/VExc	c	Wind_Dir	Degrees	UNI3	[+Vs-> H] [+VExc-> E] [-Vs and -VExc-> G]
4	Unipolar Voltage	d	HD9408TRBARO	mbar	UNI4	[Signal-> H] [Ground-> G]
5	Radiometry	e	LP_NET_07	W/m2	BIP3	[+Signal-> H] [-Signal-> L]
6	Radiometry	f	LP_PYRA_02	W/m2	BIP4	[+Signal-> H] [-Signal-> L]
7	Rain Gauges	g	HD2013	mm	SW IN 1	[Signal-> SW IN 1] [Ground-> ISOLTED ground]
8	Switch Closure	h	Cup_Anemom.	m/s	SW IN 2	[Signal-> SW IN 2] [Ground-> ISOLTED ground]

The physical connection of the sensors is shown below:

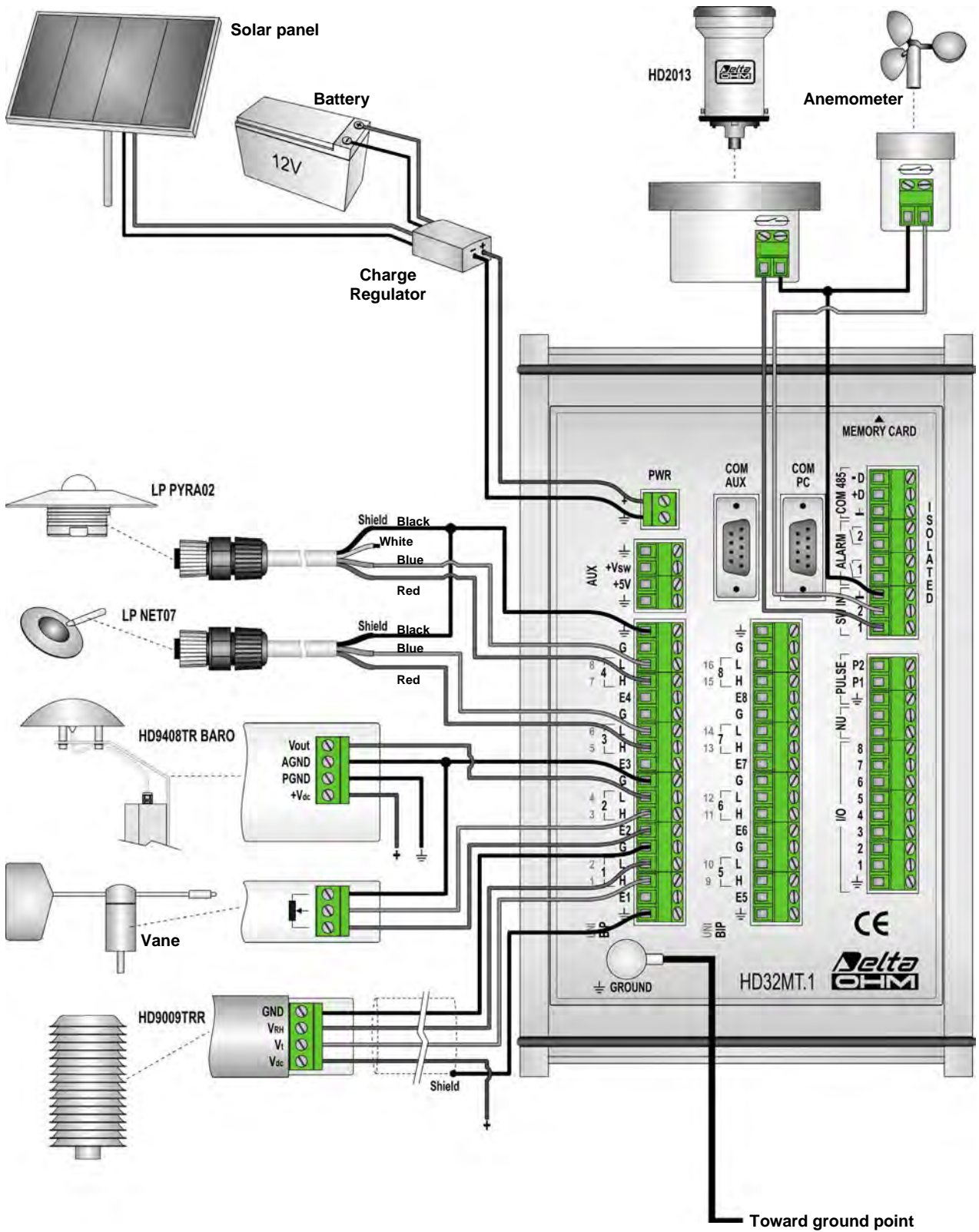

Note: for simplicity, in the figure have been omitted the ground connections of the individual sensors.

Example 2

In this example, measurements of temperature, relative humidity, pressure, wind speed and direction are made by the ultrasonic anemometer HD52.3D147. The sensors installed in the weather station thus becomes:

- **HD52.3D147 Ultrasonic anemometer**
connected to the logger via the RS485 port (**COM 485**)
- **LP NET 07 Net radiometer with mV output**
connected to the analog differential input number 1
- **LP PYRA 02 Pyranometer with mV output**
connected to the analog differential input number 2
- **HD2013 tipping bucket rain gauge**
connected to the SW IN input number 1

The HD52.3 D147 is connected to the main power supply of the system.

The connection diagram provided by the software program takes the following form:

HD32MT.1 Wiring Diagram						
	Measure Data	#	Name	Unit	Channel	Wiring
1	HD52.3D SpeedWind	a	W_Speed	m/s	COM 485	[DATA+ -> D+] [DATA- -> D-] [Ground-> ISOLATED ground]
2	HD52.3D Direction	b	W_Dir	degrees		
3	HD52.3D Pressure	c	Pressure	mbar		
4	HD52.3D Temperature	d	Temperature	deg C		
5	HD52.3D R. Humidity	e	Rel_Humidity	%		
6	free	—	—	—		
7	free	—	—	—		
8	free	—	—	—		
9	free	—	—	—		
10	free	—	—	—		
11	Radiometry	f	LP_NET_07	W/m2	BIP1	[+Signal-> H] [-Signal-> L]
12	Radiometry	g	LP_PYRA_02	W/m2	BIP2	[+Signal-> H] [-Signal-> L]
13	Rain Gauges	h	HD2013	mm	SW IN 1	[Signal-> SW IN 1] [Ground-> ISOLTED ground]

Note that for ultrasonic anemometers there are always 10 quantities reported, although the quantities actually measured could be less. At unused quantities, dashed lines appear.

The physical connection of the sensors is shown below:

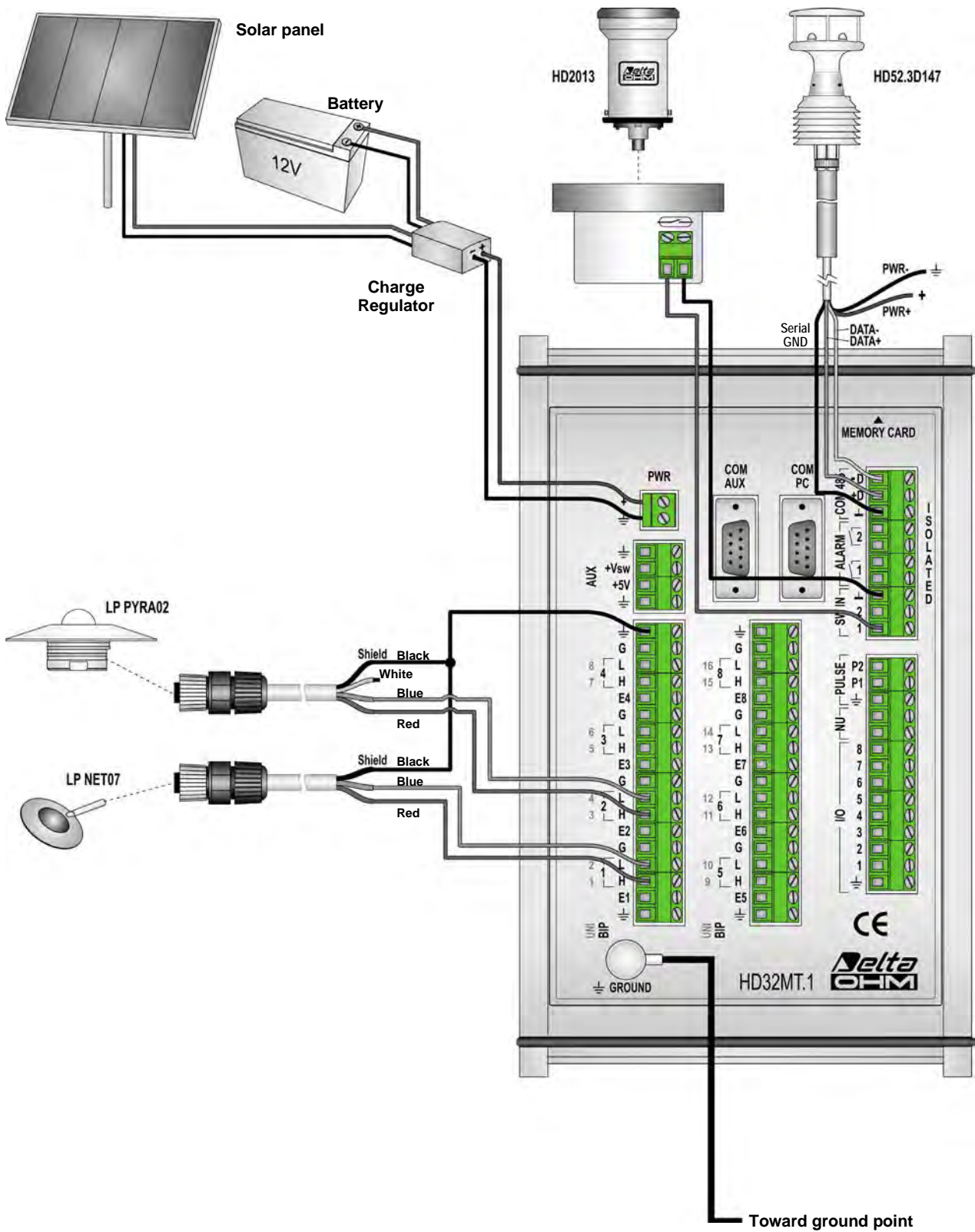

Note: for simplicity, in the figure have been omitted ground connections of the individual sensors.

6 CONNECTION TO THE PC

The data logger can be connected to a PC to do the programming, view real-time measurements or to download stored data.

There are several ways to connect the instrument to the PC:

- RS232 or USB direct cable connection
- connection via RS485 line with RS232/RS485 adapter
- connection via optical fiber
- connection via radio modem (radio modem version only)
- connection via a Local Area Network (LAN) with RS232/Ethernet adapter
- connection via Internet with IP modem and TCP/IP server protocol

To connect to the PC use the **COM PC** RS232 serial port, with type D-sub 9-pin male connector.

Note: Communication with the PC is established even in the absence of a program installed in the data logger. In the absence of an operating program, the instrument does not make measurements or recordings, then will not be available monitor and data downloading functions, but will only be available the programming function.

Here are the wiring diagrams for the various modes.

6.1 RS232 OR USB DIRECT CONNECTION VIA CABLE

Connect the serial cable between the data logger **COM PC** port the and the PC. Depending on the data logger that connects to a serial port RS232 or USB port, use the following cables:

- the cable code **9CPRS232** "null modem" to connect to a RS232 serial port.
- the cable code **C.205** for connection to a USB port, installing the drivers for the PC (the cable has a built-in RS232/USB converter).

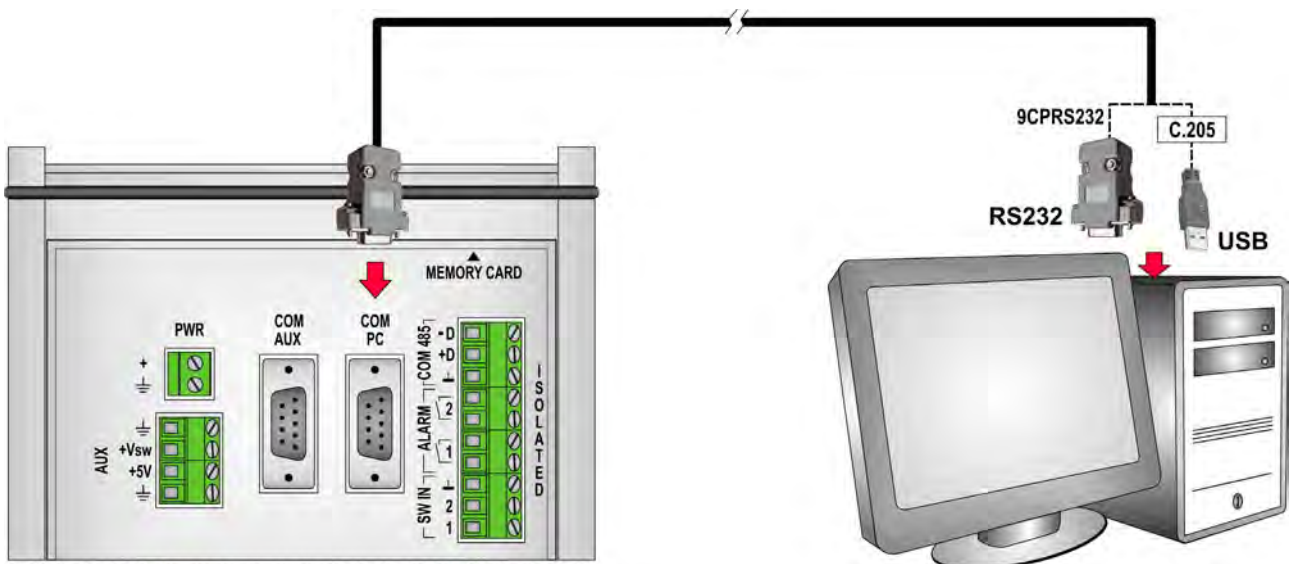

For connection to an RS232 serial port you can use a standard RS232 "**null modem**" cable. The cable should have female connectors on both sides, and the instrument end of the connector must be 9-pin Sub-D type. The cable must not exceed a length of 15 meters.

6.2 CONNECTION VIA RS485 LINE

For the connection via RS485 line, a RS232 / RS485 adapter, for example the **HD7520R** module, must be placed between the data logger and the RS485 line.

Connect a standard RS232 serial cable between the data logger **COM PC** port and the adapter RS232 serial port. The cable has female connector on the side of the instrument and male connector on the side of the adapter. The connectors are 9-pin Sub-D type. The length of the cable must not exceed 15 meters.

In the RS485 connection, the devices are connected in a sequence through a shielded cable with twisted pair for signals and a third wire for the common.

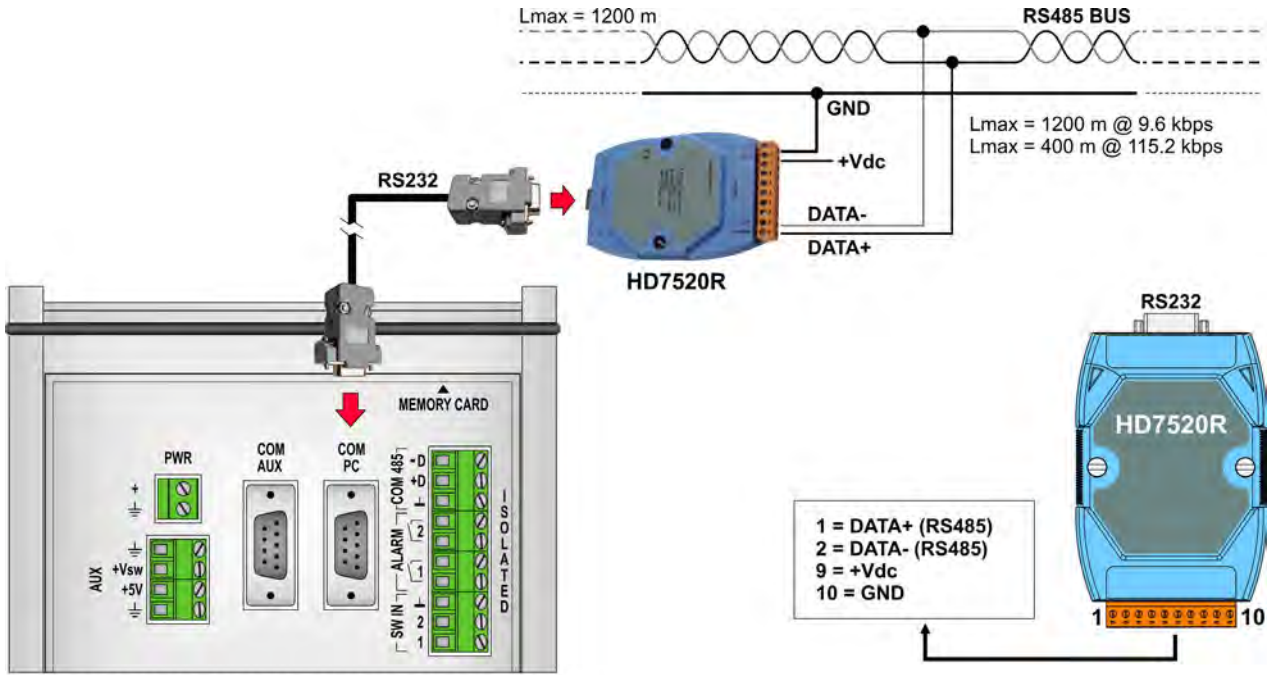

The power supply of the HD7520R adapter is 10...30 Vdc.

To set the data logger as "Modbus Slave" unit with **Modbus-RTU** protocol, see chapter 10.

6.3 CONNECTION VIA OPTICAL FIBER

For the connection via optical fiber, the **HDTCF-142-M** module must be placed between the data logger and the optical fiber. The power supply of the HDTCF-142-M module is 12...48 Vdc.

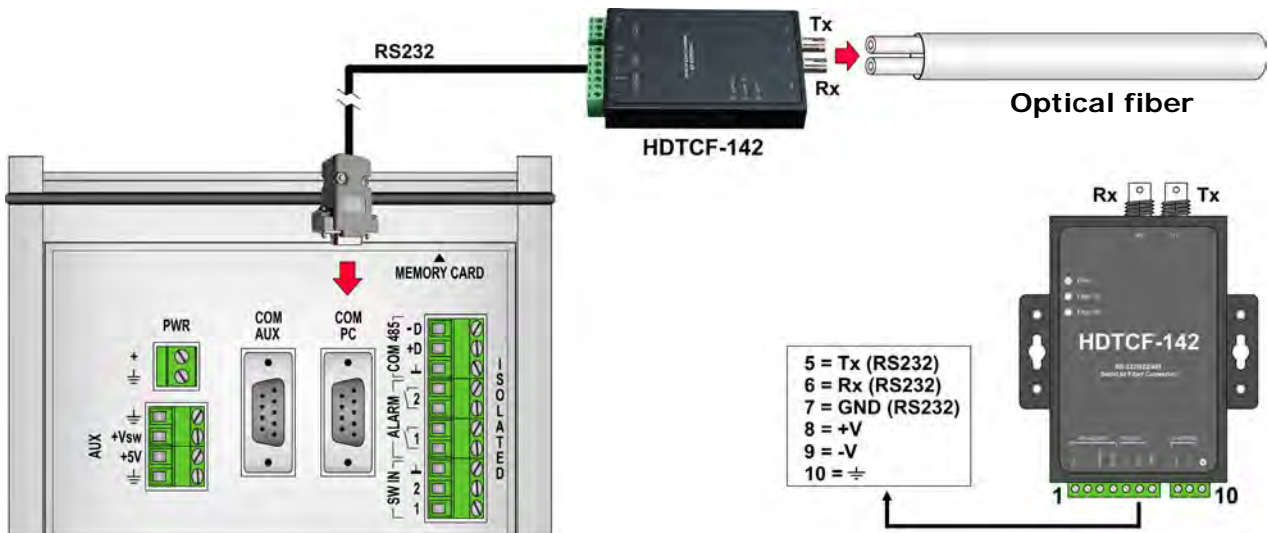

6.4 CONNECTION VIA RADIO MODEM (ONLY FOR THE RADIO MODEM VERSION)

In the model with radio modem option, a radio communication between instrument and PC can be established through the use of the external optional VHF radio modems.

You need two radio modems: one connected to the **COM PC** port of the instrument and one connected to your PC. The two radio modems must be connected to the respective antennas, through the coaxial cables with BNC connector, the cables are fixed length.

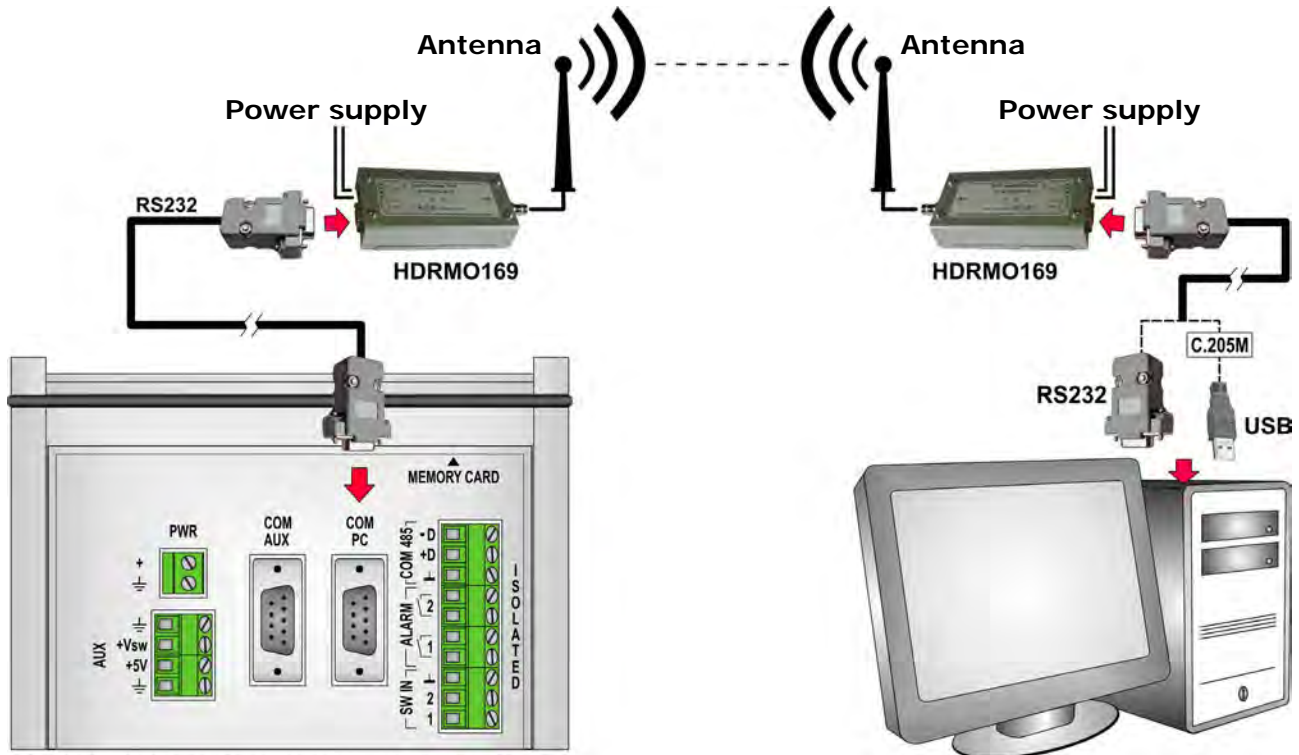

The two cables that connect the radio modem to the instrument and the PC are the same. They are standard RS232 serial cables with female connector on the side of the instrument and male connector on the side of the modem. The connectors are 9-pin Sub-D type. The length of each cable must not exceed 15 meters. If your PC has no RS232 port but only USB ports, it can be placed between the modem and the PC the cable **C.205M** with built-in RS232/USB converter, in which case make sure you install the drivers in the PC.

The radio modem must be configured with a serial communication speed of 38400 bits/s and should be able to handle the RTS and CTS signals.

The maximum distance between the two radio modems depends on various factors, including the power output of the radio transmitter, the sensitivity of the radio receiver, the antenna type used and the presence of obstacles between the two antennas.

For VHF Radio Modems with a power output of 500 mW (effective radiated power), operating at 169MHz with a whip antenna, the distance can vary from 12 to 15 km in the open air and from 2 to 3 km inside buildings.

Upon request, Delta OHM provides VHF Radio Modem with 169 MHz frequency, pre-configured and ready for use, including a whip antenna and RS232 serial port.

Warning:

1) The two Radio Modems provided by Delta OHM are configured differently and therefore are not interchangeable between PC and data logger, connect the two modems according to the instructions given on the modems.

2) It is guaranteed the functioning of the instrument with the Radio Modems provided by Delta OHM. We can not guarantee the compatibility of radio modems other than those supplied.

Note: Even if the radio modems communicate with the instrument and the PC at 38400 bit/s, the total communication speed of the system depends on the speed of data transfer between the two radio frequency modems. For example, if the communication speed between the two radio modems is 3600 baud, also the total communication speed of the system is limited to 3600 baud.

6.5 CONNECTION VIA ETHERNET LOCAL AREA NETWORK

For the connection via Ethernet Local Area Network (LAN), a RS232 to Ethernet adapter must be placed between the data logger and the local network: **HD5110** module for the standard Ethernet connection, **HDMB3180** module for the Ethernet connection with **Modbus TCP/IP** protocol.

Connect the **9CPRS232** "null-modem" serial cable between the data logger **COM PC** port and the adapter RS232 serial port. Connect a standard Ethernet cable between the adapter and the local network.

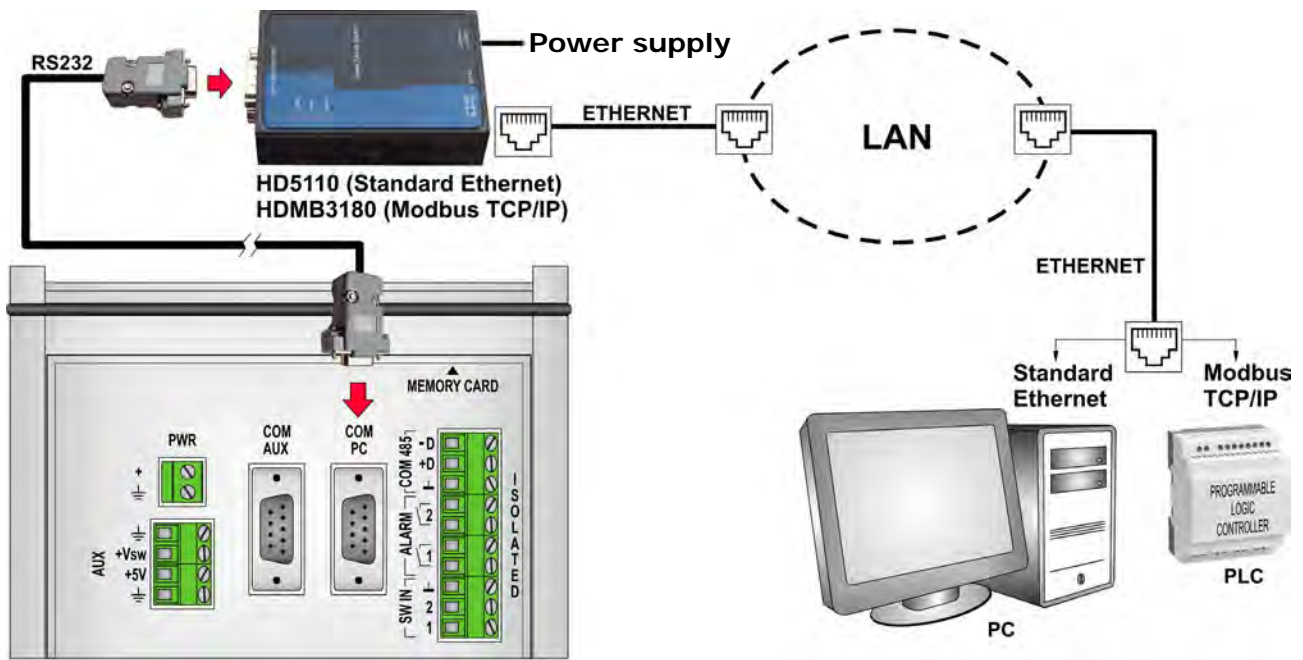

The power supply of the adapter is 12...48 Vdc.

The HD5110 adapter must be configured with the following RS232 serial communication parameters:

	Basic Datalogger	Datalogger with Radio Modem option
Baud Rate	115200	38400
Data bits	8	8
Parity	N	N
Stop bits	1	1
Flow control	None	None

With the HDMB3180 adapter, the data logger must be set as "Modbus Slave" unit with **Modbus-RTU** protocol, and the adapter must be configured with the Modbus communication parameters set in the data logger (see chapter 10).

6.6 CONNECTION VIA INTERNET WITH IP MODEM AND TCP/IP SERVER PROTOCOL

In the basic version of the data logger, a communication between instrument and PC can be established via Internet through the use of the external optional WCDMA/HSDPA/HSUPA IP modem **HDF2414**. The modem is connected to the data logger **COM PC** port.

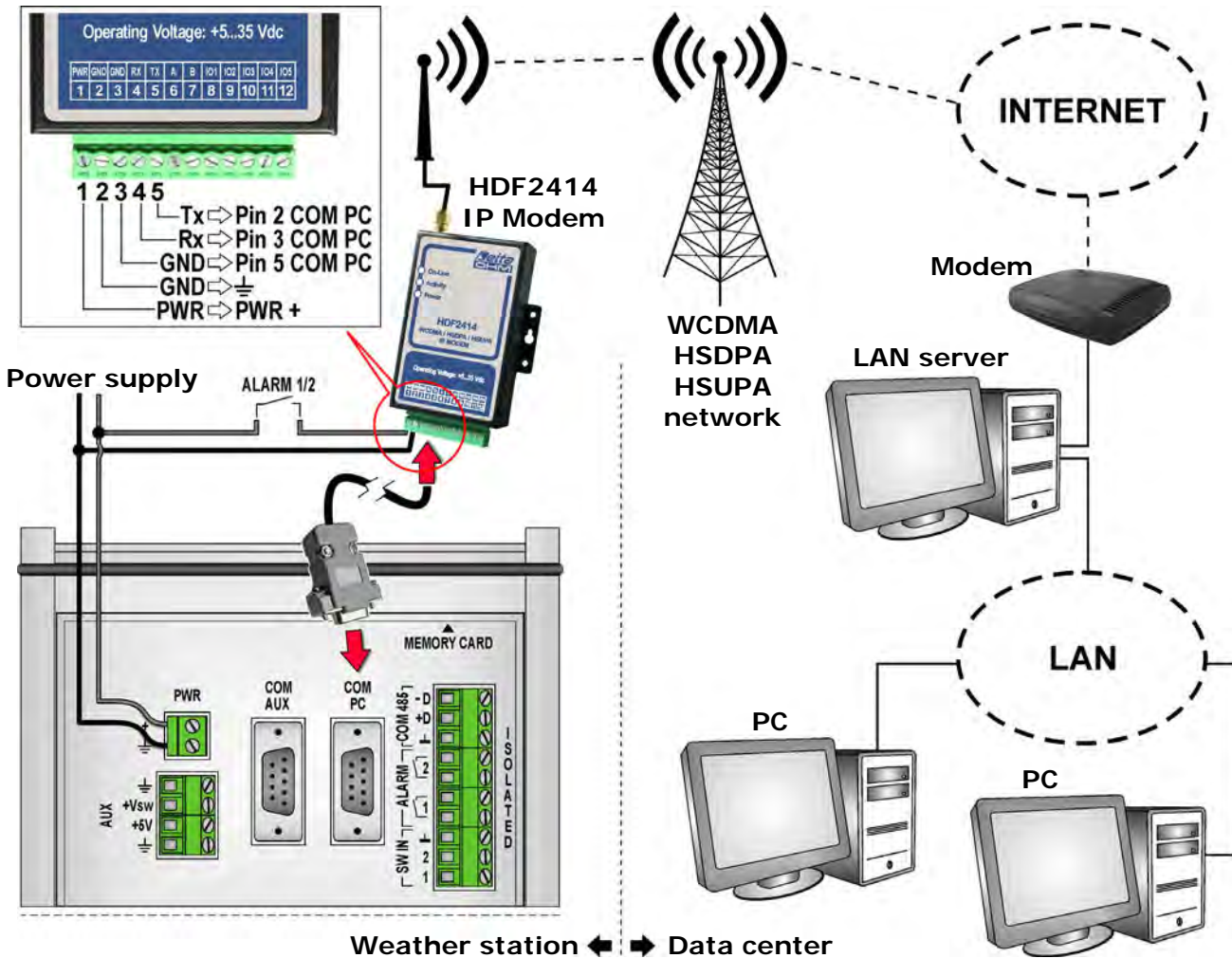

In the modem must be inserted a **SIM** card enabled for data transmission. The card must be obtained from a telephone operator that has a suitable network coverage in the place where you will install the system. The SIM must be inserted with the modem turned off. The SIM housing is located at the top of the modem (antenna side). To insert the SIM, press the button next to the housing with a sharp object, extract the housing and insert the SIM, then put the housing back in place.

The modem must be configured with the information for network access (APN, user name, password) and the IP address or the domain name of the data center (or centers) with which to connect. The configuration is done by connecting the serial output of the modem directly to a PC and using the software "IP Modem Configure" included in the folder "IP_Modem" of the CD-ROM supplied with the instrument.

To the modem must be connected its antenna. Three LED indicators show the modem operating status: On-Line (on if the modem is registered in the network), Activity (blinking during communication) and Power (on if the modem is powered).

To reduce the power consumption of the weather station, the modem power supply can be activated at regular intervals by connecting one modem power line to the contact of one of the two alarm output ALARM 1 or ALARM 2 of HD32MT.1 data logger, as shown in the figure above. The selection of the output and contact closure interval is done with the HD32MTLogger software when the program of measures and recordings is installed in the data logger (please see the instruction of the software).

7 GSM CONNECTION

In all the versions of the data logger, the optional **HD5320** external GSM/UMTS module (or the **HD53GSM** GSM/GPRS module) can be connected. By connecting the GSM/UMTS module, the data logger is capable of sending alarm messages via **SMS** to mobile phones, and information about the data stored via Internet to **e-mail** and **FTP** addresses.

The module is connected to the data logger **COM AUX** port. To the module must be connected its antenna.

The cable connecting the logger to the module is a standard RS232 serial cable with female connector on the side of the instrument and male connector on the side of the module. The connectors are 9-pin Sub-D type. The cable length must not exceed 15 meters.

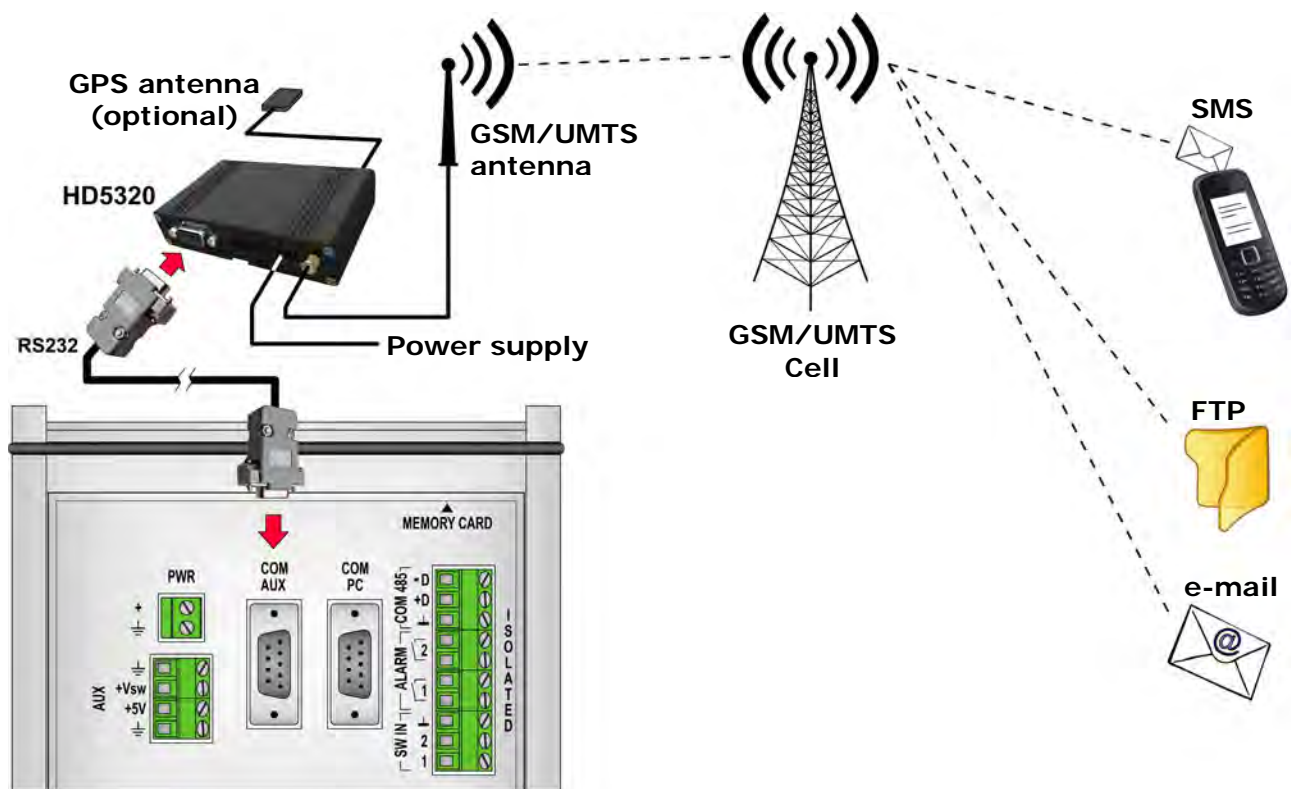

The module must be configured with a serial communication speed of 115200 bits/s.

In the module must be inserted a **SIM** card enabled for data transmission. The card must be obtained from a telephone operator that has a suitable GSM/UMTS network coverage in the place where you will install the system.

Information on telephone numbers and e-mail and FTP addresses are stored in the data logger using the HD32MTLogger software (see software manual).

For the transmission of data via e-mail and FTP, you must have an SD card inserted in the data logger, since the data logger transmits data stored on the card and not in internal memory. The memory card is not needed for sending the alarm SMS.

On request, the HD5320 module can be supplied with the **GPS** option, to automatically update the clock of the data logger and identify the installation site (latitude, longitude, altitude).

INSERTING THE SIM CARD IN THE HD5320 MODULE:

1. Disconnect the power supply.
2. Press, with a pointed object, the release button of the SIM tray on the top of the HD5320 module and extract the tray by making it slide upward.

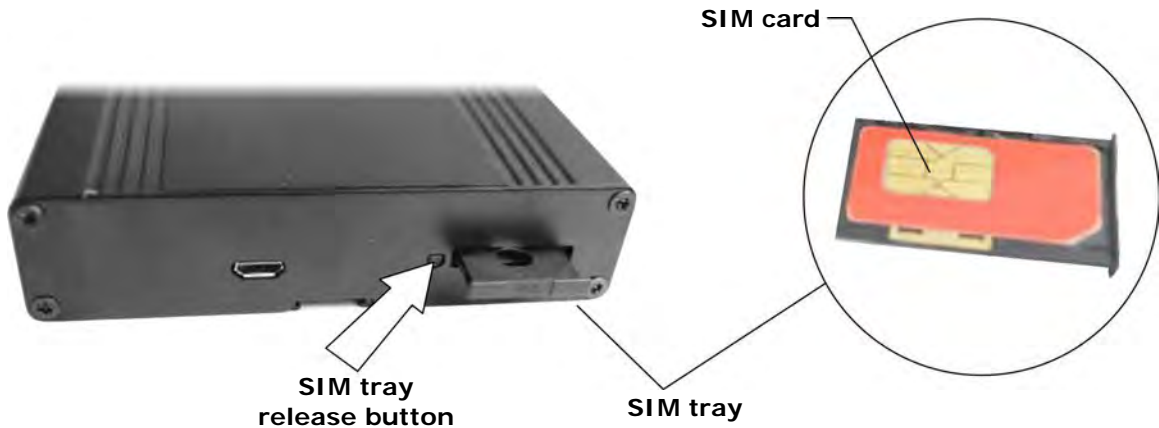

3. Insert the SIM card into its tray so as the SIM card contacts face the outside of the tray. The tray is provided with an insertion key that prevents the possibility of inserting the SIM card improperly.
4. Put the SIM tray back in place, making sure that the SIM card contacts face the cover of the data logger housing.

POWER SUPPLY OF THE HD5320 MODULE:



HD53GSM MODULE:

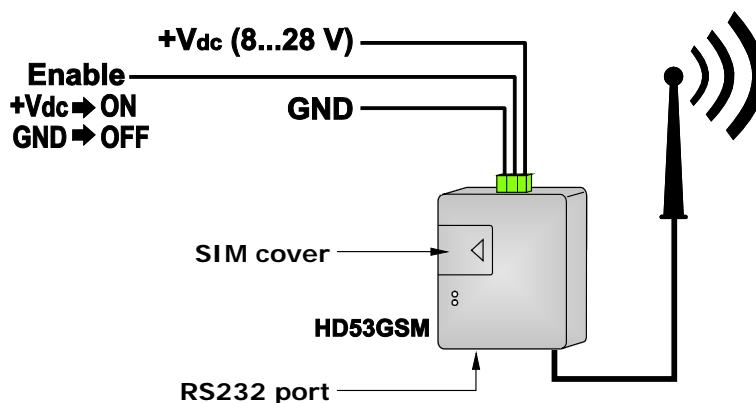

8 CHANGING THE CONFIGURATION

The chapter is dedicated to those who have a data logger with a measures and stores program installed and need to quickly make small changes in the program, for example to change the acquisition interval or replace a sensor, without having a thorough knowledge of the programming mode.

The possibility of modifying the program are illustrated by typical examples of changes that may be required. This chapter is not intended as a substitute for a complete discussion of programming; if you are unsure about the changes to be made you should refer to chapter 9 which shows in detail the programming mode and chapter 5 for details on the possibilities for sensor connection.

The program of measures and recordings can be changed even if the data logger is already installed and running in a system.

The program change is divided into the following steps:

- Connecting to a PC and reading the program installed in the data logger.
- Changing the configuration of sensors or acquisition/storage intervals.
- Installing the modified program in the data logger

8.1 CONNECTING TO THE PC AND READING THE PROGRAM INSTALLED

Changing the installed program requires that the instrument is powered on and connected (directly, via modem or via local network) to a PC where the **HD32MLogger** software is installed. If the instrument is not already connected, connect the instrument by one of the methods described in chapter 6 on page 36.

Proceed with the following points:

- 1 On the PC, run the **HD32MLogger** software via the icon on the desktop or selecting the program in the *Delta OHM folder of Programs menu*.
- 2 If the datalogger is connected directly to a RS232 or USB port of the PC, or it is connected through a Radio Modem, select the *Serial Connection* item in the *Tools* menu to configure the connection.

If the datalogger is connected through a Local Area Network with TCP/IP protocol or through Internet with IP modem, select the *TCP/IP connection setup* item in the *Tools* menu to configure the connection.

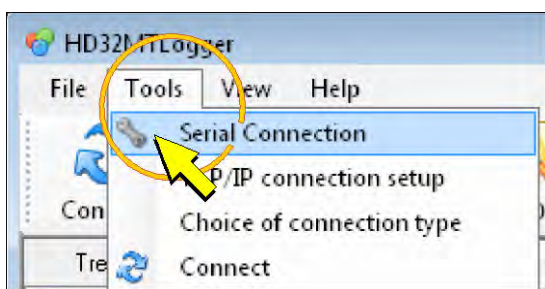

Direct or Radio Modem connection

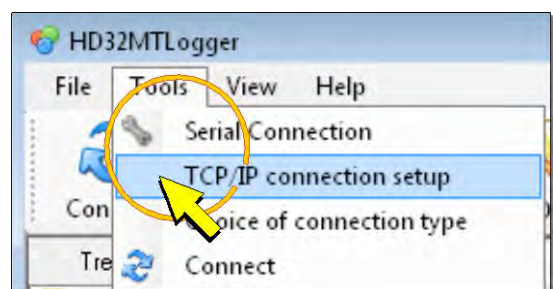

Local network or IP modem connection

- 3 Configure the connection as follows:

3.1 Direct or Radio Modem connection configuration:

In the *Connection Properties* window, apply the check mark next to the *Radio Modem* indication for the model with Radio Modem option. For the base model, make sure the check mark is not present; if the check mark is present, click on the box next to the indication to deselect.

Model with Radio Modem option

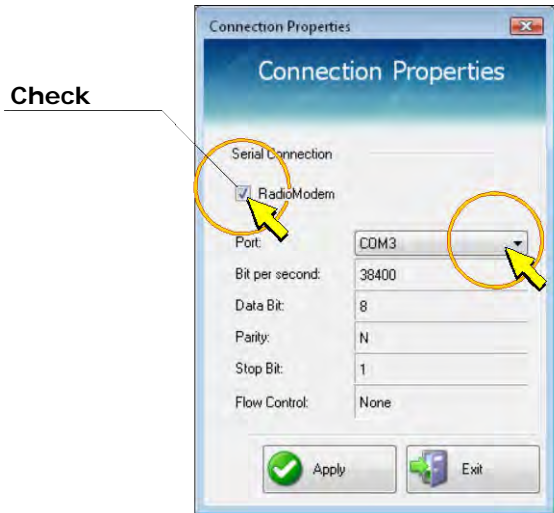

Basic Model

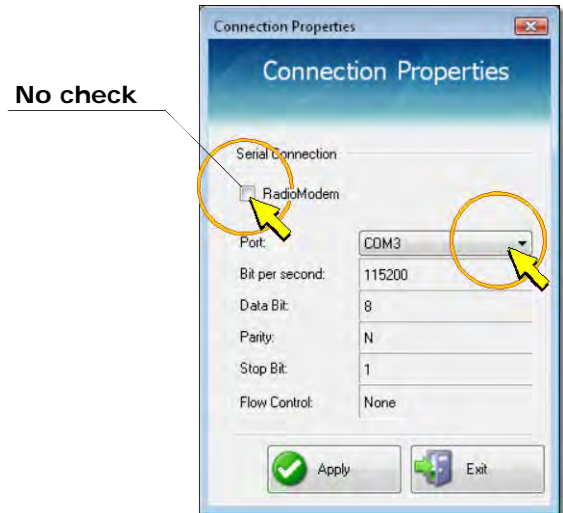

Select the COM port number of the PC which is connected to the instrument or radio modem, then click *Apply* to return to the main window.

If the COM port number is not known, leave the setting unchanged and press *Apply* to exit, the program will automatically search for an instrument connected to the available ports on your PC, starting from the set.

Note: the remaining communication parameters are fixed, the difference between the two models of data loggers is the data transfer rate (bits per second): 38400 for the model with radio modems and 115200 for the base model.

3.2 Configuration of local network or Internet with IP modem connection:

In the *TCP/IP connection setup* window, set the *IP address* (only for local network connection) and *Port* fields. The values must be equal to those set in the RS232/Ethernet adapter or in the IP modem.



Press *Apply* to store the configuration. Press *Exit* to return to the main window.

- 4 Select the *Choice of instrument model and connection type* item in the *Tools* menu.

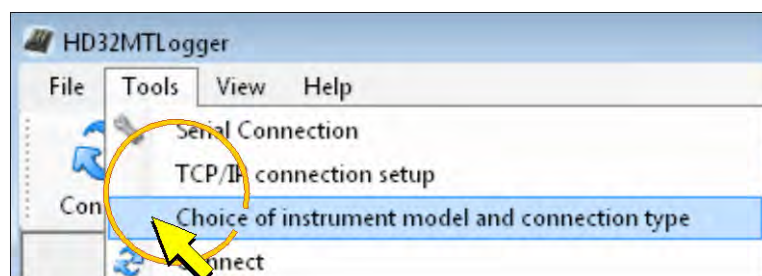

- 5 Select the model **HD32MT.1**. Select *Serial connection* if the datalogger is connected directly to a RS232 or USB port of the PC, or it is connected through a Radio Modem. Select *TCP/IP client connection* if the datalogger is connected through a Local Area Network with TCP/IP protocol and RS232/Ethernet adapter. Select *TCP/IP server connection* if the datalogger is connected through Internet with IP modem.

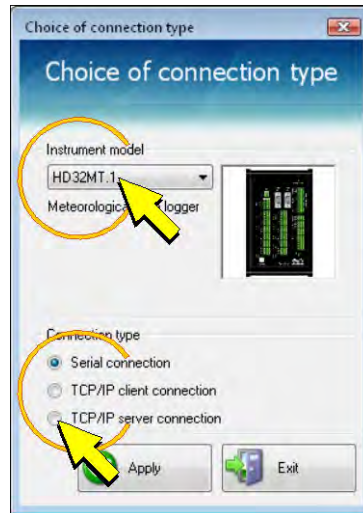

Press *Apply* to store the choice. Press *Exit* to return to the main window.

- 6 Select the *Connect* icon in the toolbar.

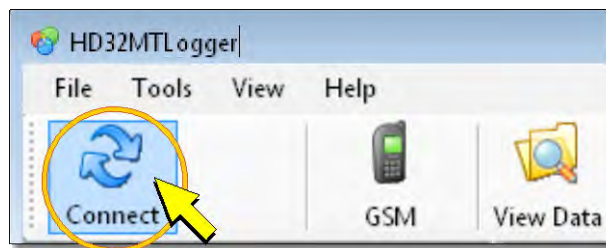

- 7 If the connection is successful, the software reads the program installed in the datalogger and asks to enter the password. Write the password in the *Password* field and press *OK*. The factory default password is 00000000 (8 zeros).



Note: by pressing *Cancel* or *OK* without entering the password or *OK* with wrong password, it will not be possible to change the data logger settings. By pressing *OK* with wrong password, an error message will appear; to insert the password again, disconnect and connect again the data logger.

- 8 After the connection, the *DataLogger Information* window is displayed, with the data logger model, serial number, firmware version, the name of the program installed in the data logger, the acquisition interval and the number of store tables (a store table is a list of measures that are stored together).

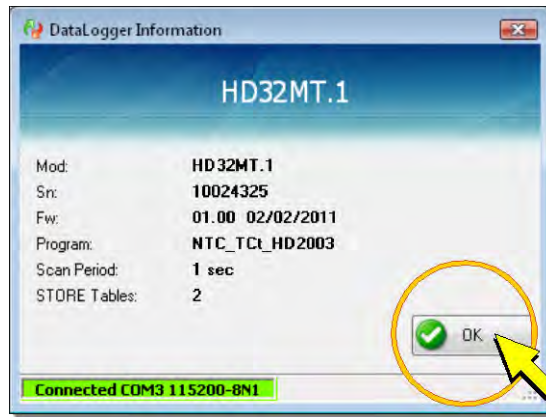

Press *OK* to access the software main window.

Note: when the logger is connected to your PC, capture and storage measures continue normally in accordance with the requirements of the program installed.

Note: If you attempt a connection while the logger is recording data in the SD memory card, you receive a warning message (*SD Card Running*). In this case, wait a few minutes and try to press the *Connect* icon again.

If you experience connection errors, follow the instructions of paragraph 9.5.1 on page. 100

- 9 Select the *Program Setup* icon in the command bar.



- 10 In the window that appears, select *RUNNING Program*.

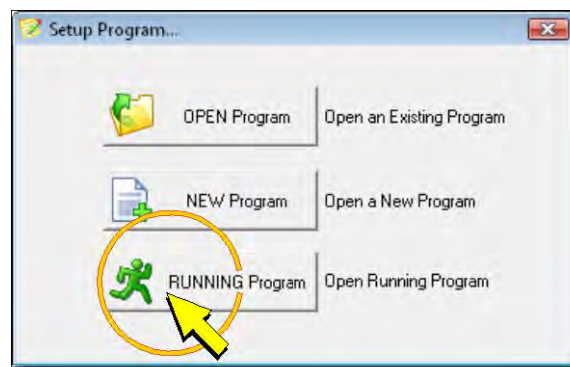

- 11 The window of the program installed appears and it is now possible to make the desired changes.

8.2 CHANGING THE INSTALLED PROGRAM

The possibilities of modifying the installed measures and recordings program are illustrated by the following four examples:

1. Changing the measures recording interval.
2. Changing the parameters of a sensor.
3. Adding a sensor.
4. Removing a sensor.

8.2.1 CHANGING THE MEASUREMENT RECORDING INTERVAL

The measurements stored by the data logger are listed in the tables called *Table n*, that appear on the left of the installed program window.

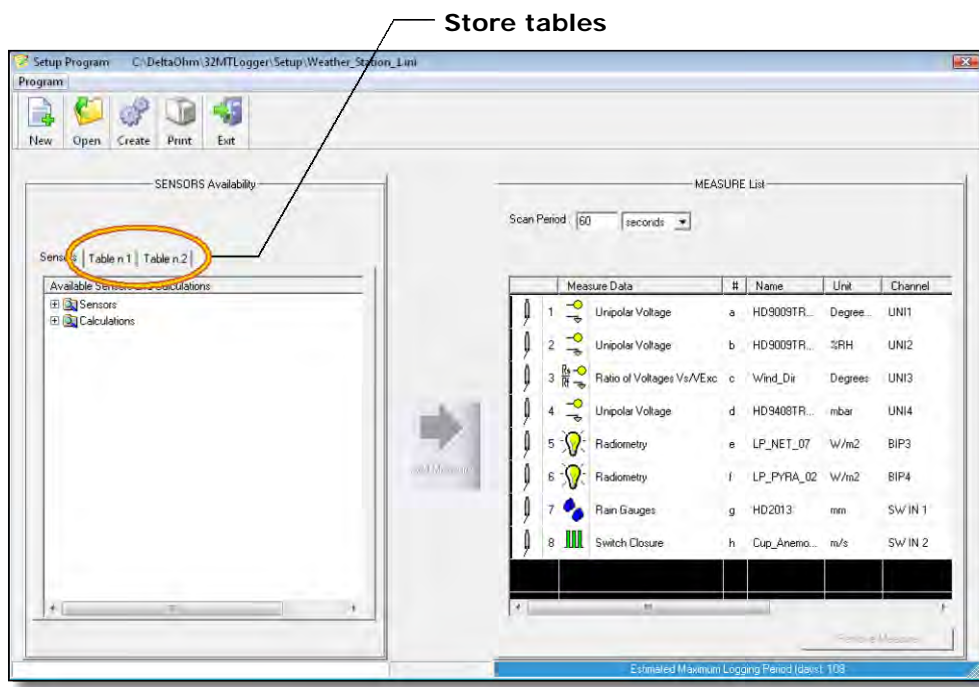

Measurements can be listed all in a single table (*Table n.1*) or can be divided into multiple tables numbered in sequence (*Table n.1*, *Table n.2*, etc.). Different tables may have different recording intervals.

To change the recording interval proceed as follows:

1. Select the table where you want to change the recording interval, by clicking the corresponding tab.

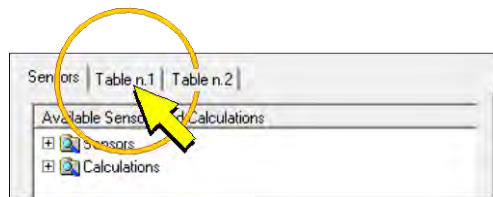

2. Write the new interval value in the field to the right of the indication *Store Period*. If necessary, select *minutes* or *seconds* for the interval unit of measurement.



Note: the recording interval (*Store Period*) must be equal or multiple of the acquisition interval (*Scan Period*) which appears on the right side of the window.



3. Press *Create* to save the changes and generate the file necessary for the data logger.



The window that allows you to specify the file name and path where to save it to your PC appears. After saving, a summary report is displayed, press *OK* to return to the program window.

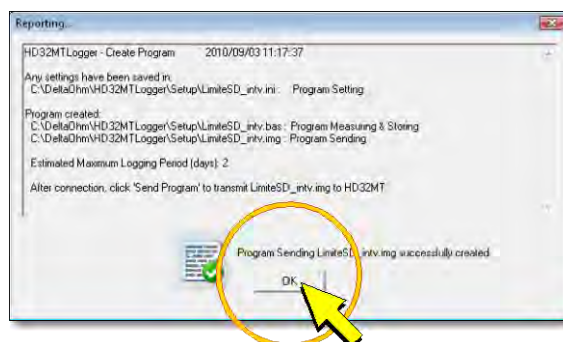

4. In the program window appears, on the lower right, the estimated number of days needed to fill the internal memory of the data logger with the new recording interval (*Estimated Maximum Logging Period*)

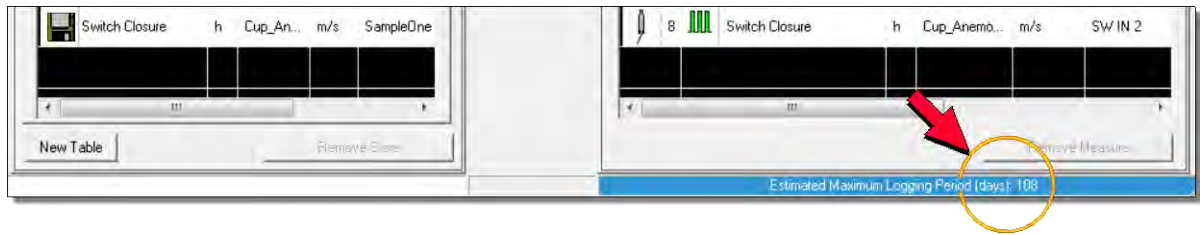

5. Press *Exit* to close the program window.

The program is ready to be installed in the data logger. Please see section 8.3 on page 58 for how to install it.

8.2.2 CHANGING THE PARAMETERS OF A SENSOR

The sensors used are listed in the right part of the program window, in the section entitled *MEASURE List*.

Changing the parameters of a sensor may be necessary, for example, when a sensor is replaced with another of the same type, and should therefore enter the configuration values of the new sensor.

To change the parameters of a sensor, proceed as follows:

1. Make sure that in the left side of the window of the program is selected the panel *Sensors* (the panel is selected by default when opening the program).

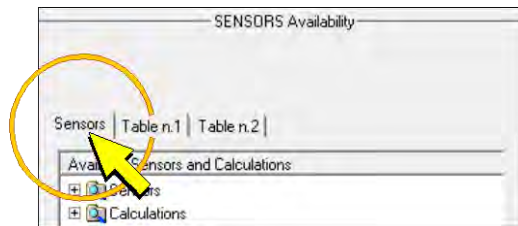

2. In the list of sensors (*MEASURE List*) that appears in the right side of the window, double click on the row of the sensor which you want to change the parameters.

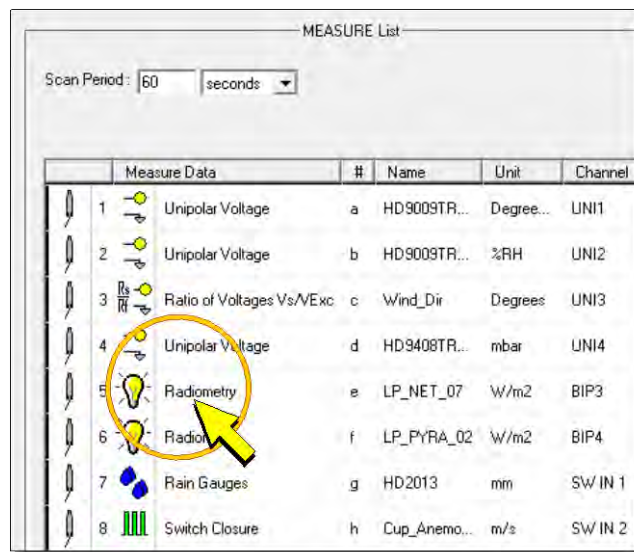

- This opens the configuration window that displays all the available parameters for the desired sensor. Write or select a new value at the required parameter, then press OK to close the window.

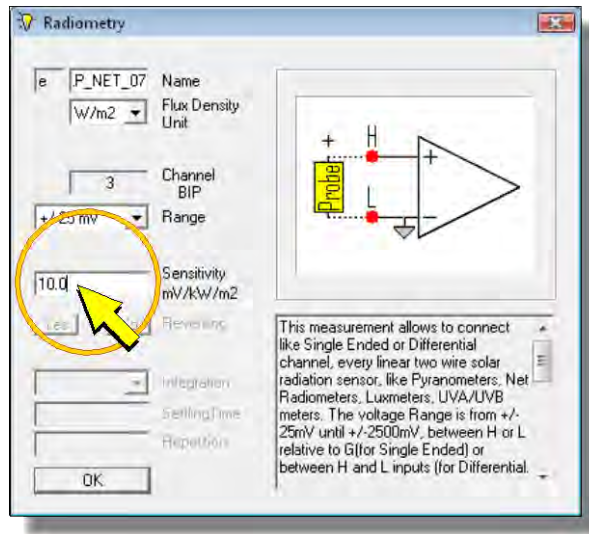

Note: only the fields with a white background can be changed.

- Press *Create* to save the changes and generate the file necessary for the logger.

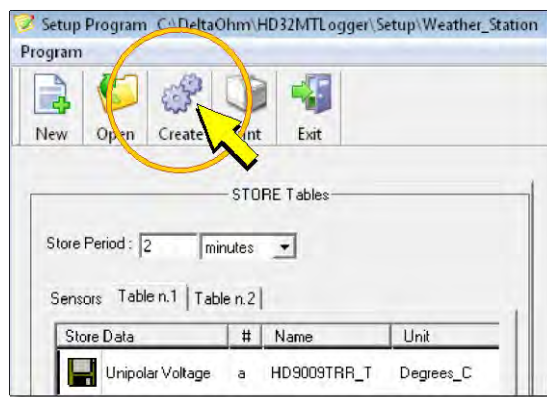

The window that allows you to specify the file name and path where to save it to your PC appears. After saving, a summary report is displayed, press *OK* to return to the program window.

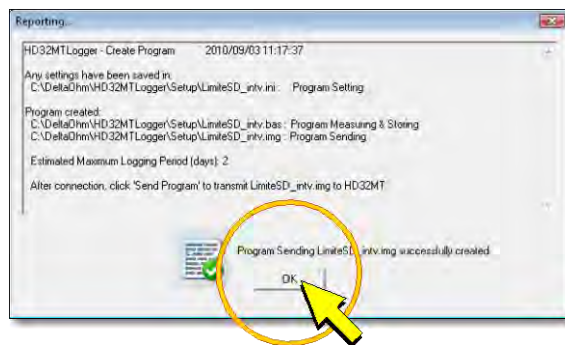

- Press *Exit* to close the program window.

The program is ready to be installed in the data logger. Please see paragraph 8.3 on page 58 on how to install it.

8.2.3 ADDING A SENSOR

It is described below how to add an additional sensor to the list of those already in the program.

1. Make sure that the *Sensors* panel is selected in the left side of the window of the program (the panel is selected by default when opening the program).

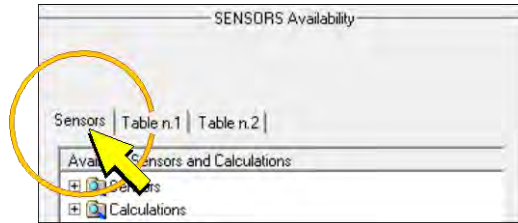

2. Expand the *Sensors* folder and then the folder containing the type of sensor to add (e.g. *Industry*). Then select the type of sensor and make a click on the *Add Measure* button with the green arrow at the center of the window (or alternatively perform a double click on the desired sensor).

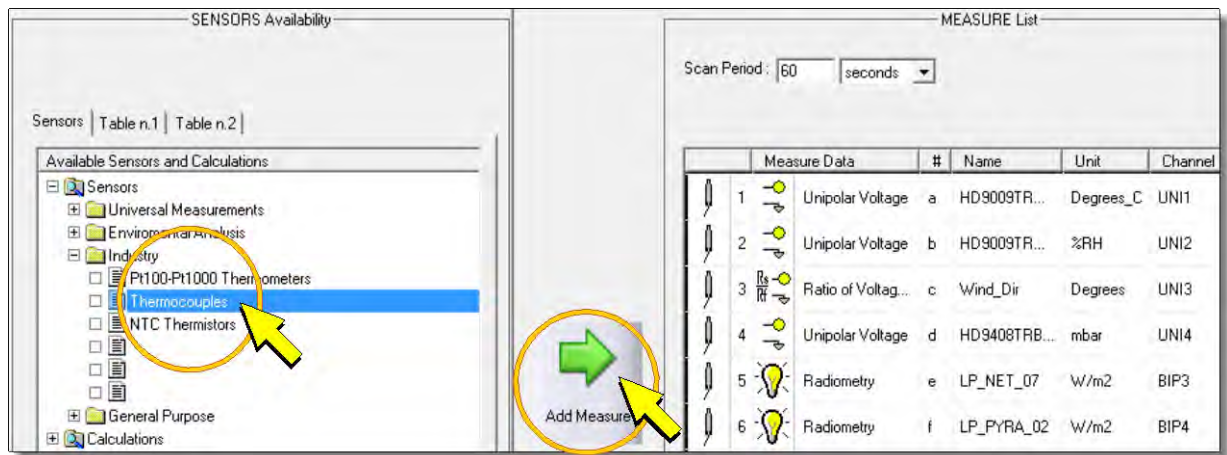

3. The configuration window appears, where you can enter all the required parameters.

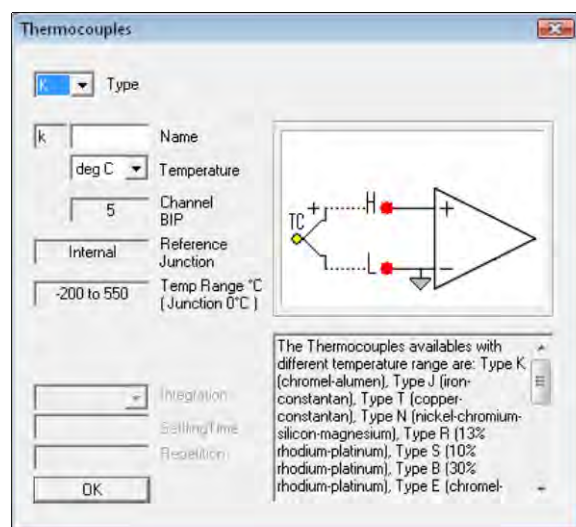

Define the sensor name in the *Name* field (for example, you can enter the model of the sensor). Then fill in all editable fields (only the ones with white background) depending on the characteristics of the new sensor.

Note: for a full description of the parameters relating to each type of sensor used, see paragraph 9.2 on page 60.

- Press **OK** to return to the program window. In the bottom of the list of measures (*MEASURE List*) the added sensor is displayed.

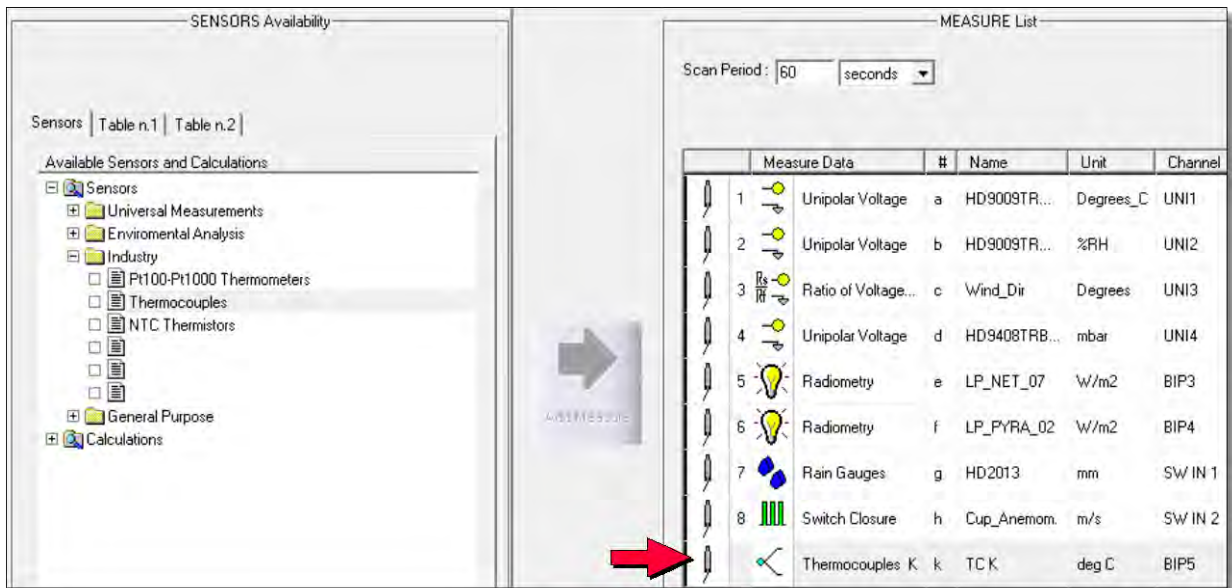

- For storing the measure of the sensor in the data logger, you must insert the measure into a store table. In the left panel, select the store table in which you want to insert the new measure.

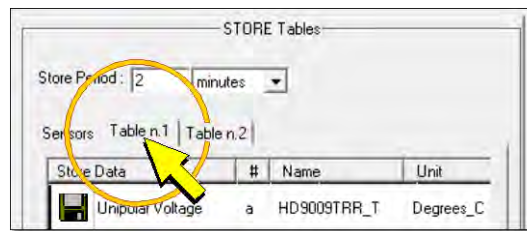

- In the right panel select the added sensor and click on the *Add Store* button with the blue arrow at the center of the window.

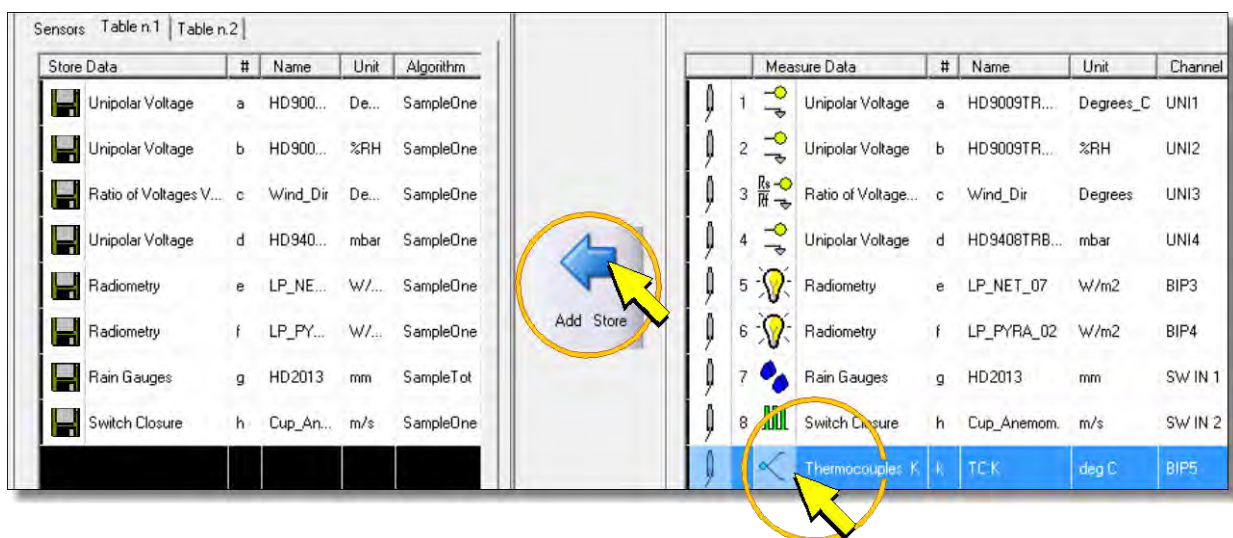

- In the window that opens (*Algorithm*), select the type of value that you want to store between: the instant value (*OneSample*), mean (*Average*), maximum (*Max*), minimum (*Min*) or standard deviation (*StDeviation*).

Note: for pulse counting it is also active total count function (*Total*).

Note: *Alarms* button is only active if you select the alarm table or if the table is empty (see section *Creating the store tables*).

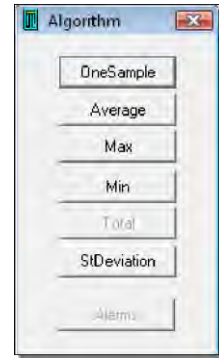

- The new measurement will appear in the left panel of the program window.

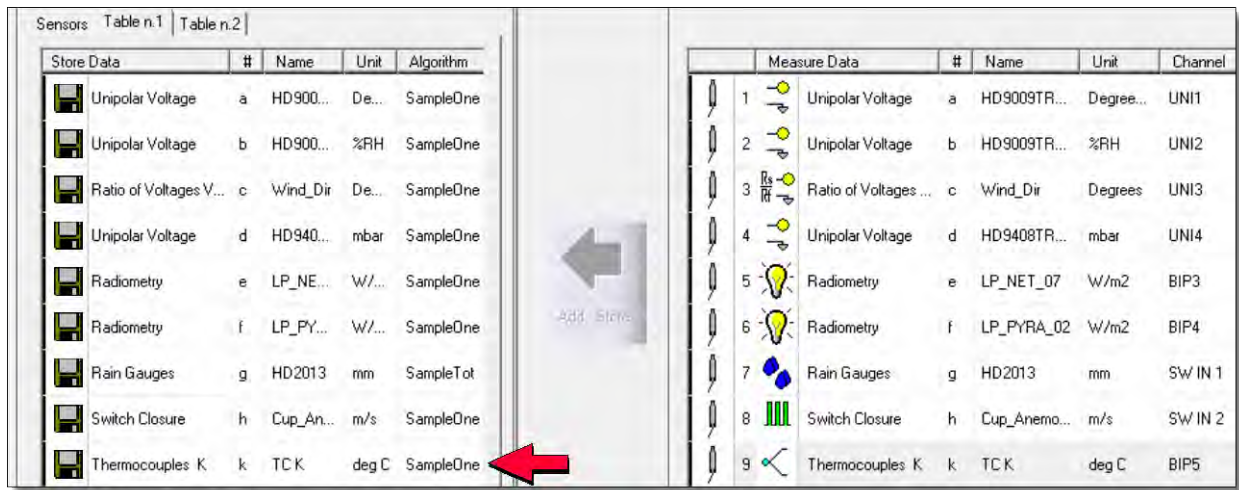

- Press *Create* to save the changes and generate the file needed by the data logger.

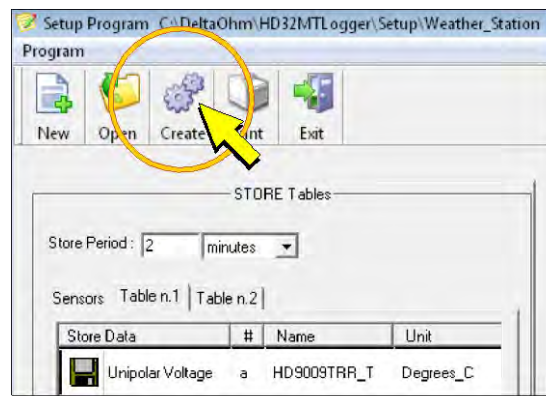

It appears the window that allows you to specify the file name and path where to save it to your PC. After saving, a summary report is displayed, press *OK* to return to the program window.

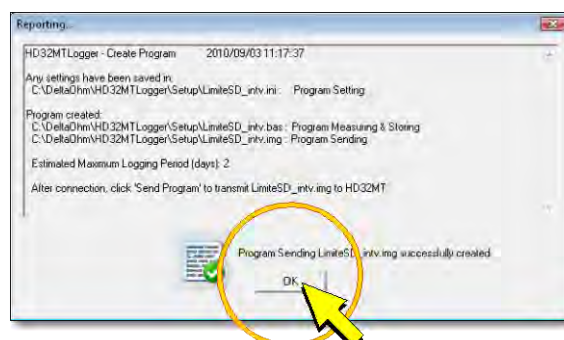

10. If you want to print the updated wiring diagram, press *Print*.



Then select *Print Wiring Diagram* and press *OK*.

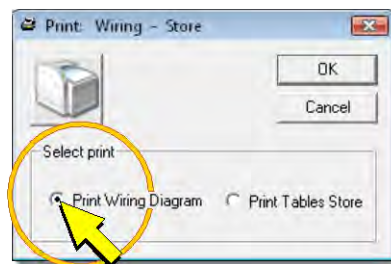

11. Press *Exit* to close the program window.

The program is ready to be installed in the data logger. Please see paragraph 8.3 on page 58 on how to install it.

8.2.4 REMOVING A SENSOR

The operation to remove a sensor is generally required when you replace one sensor with another one having a different type of output (for example if you replace a sensor with voltage output with another one with current output). In this case, you must first remove the sensor to be replaced from the program, in order to free the input of data logger and make it available for a new connection, and then add the new sensor as shown in the previous paragraph.

To remove a sensor, proceed as follows:

1. In the list of sensors that appears on the right side of the window, select the sensor you want to remove.

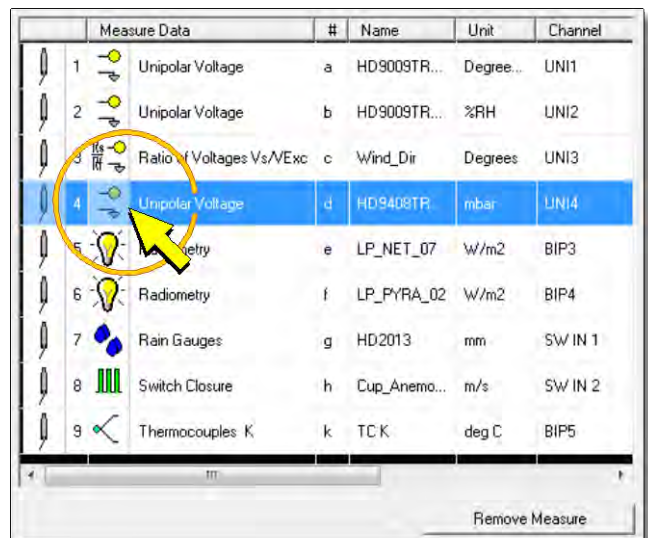

2. At the bottom of the panel, press *Remove Measure*.

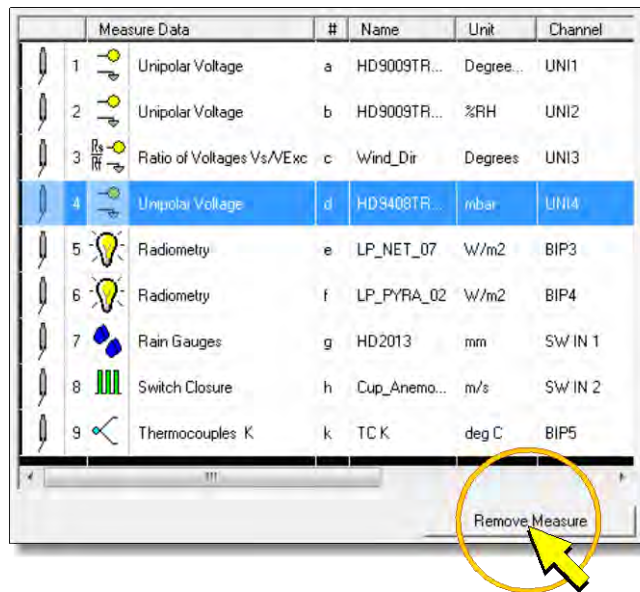

A message appears asking you to confirm the removal, press *Yes*, the sensor is also automatically removed from the storage tables.

At this point you can add a new sensor proceeding as indicated in paragraph 8.2.3, or save the changes by going on with the following points.

3. Press *Create* to save the changes and generate the file necessary for the logger.

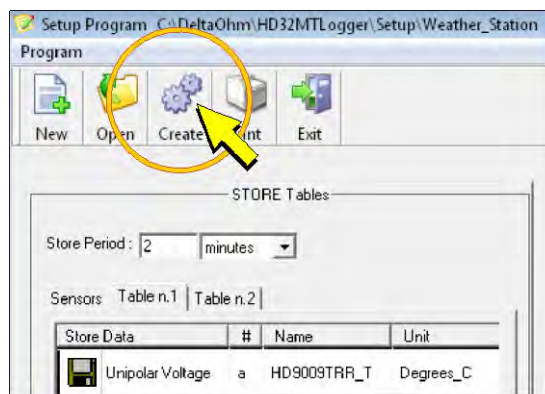

The window that allows you to specify the file name and path where to save it to your PC appears. After saving, a summary report is displayed, press *OK* to return to the program window.

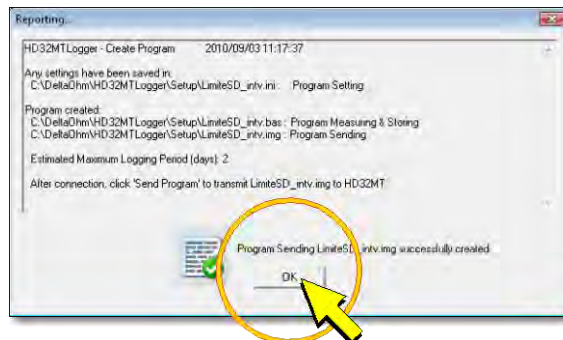

4. Press *Exit* to close the program window.

The program is ready to be installed in the data logger. Please see paragraph 8.3 on page 58 on how to install it.

8.3 INSTALLING THE CHANGED PROGRAM IN THE DATA LOGGER

After modifying the program, it must be made to work by installing it in the data logger.

Warning: The installation of a program in the data logger will erase all measurements stored in the internal memory. To avoid losing data stored in internal memory you need to transfer them to your PC using the command "Dump LOG" of the HD32MTLogger software before starting the procedure of installation of the program. The measurements stored in the removable SD memory card, if present, remain stored.

To install the program in the data logger proceed as follows:

1. Select the *Send Program* icon in the toolbar.



Note: the command is only active if the instrument is connected, otherwise proceed to the connection as indicated in paragraph 8.1 on page 45.

2. In the window that opens, the *scheduling* option is used to activate periodically one of the two alarm output ALARM 1 or ALARM 2 to power the IP modem, if present in the system (see the paragraph 6.6 on page 42). If the alarm output is not used to power the modem, select *No scheduling*, otherwise select *Start scheduling* and set the fields in the window (see the software instructions).

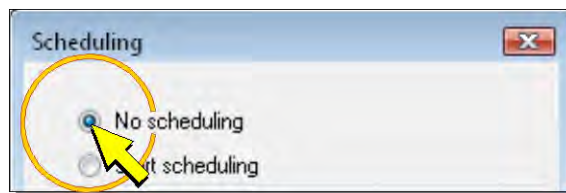

3. Press *Send*.



4. In the window that opens, select the name of the previously saved program (the programs that can be installed in the data logger have the extension ".img") and press *Open*. A message appears to remind you that measurement data will be lost. Press *Yes* to continue.
5. Wait until the program is installed in the data logger (a progress bar indicates the installation status). If the installation completed successfully, the *DataLogger Information* window is displayed again. Click *OK* to exit. The program installed starts automatically to operate in the data logger, capturing and storing the programmed measurement.

Note: The program already existing in the data logger is cleared at the beginning of the installation of the new program. During installation, if error messages appear and the installation is interrupted, the data logger is left without a working program. In this case you must repeat the installation procedure from the beginning.

6. To end the communication between PC and data logger, select the *Disconnect* icon.

9 CREATION OF THE CONFIGURATION

If the logger is supplied without a program of measures and loggings installed, you must create a program and install it by connecting the logger to the PC, all with the help of **HD32MTLogger** application software.

It is advisable to program the data logger prior to electrically connect the sensors, because the programming software automatically assigns the terminals to which sensors must be connected and does not allow an arbitrary assignment of sensors to certain inputs.

During the creation of the program it is not necessary that the logger is physically connected to the PC. The connection of the logger is only necessary to install the program at the end of the preparation.

The steps to create a program can be divided into the following phases:

- Starting the **HD32MTLogger** software and opening a new program (paragraph 9.1 on page 59).
- Defining the list of sensors to be connected to the data logger and setting of the parameters of the various sensors (paragraph 9.2 on page 60).
- Defining the calculated quantities, if necessary (paragraph 9.3 on page 100).
- Creating the store tables (paragraph 0 on page 100).
- Creating the file to be installed in the data logger (paragraph 9.5 on page 113).
- Connecting the data logger to the PC and installing the measurement and recording program (paragraph 9.6 on page 115).

9.1 CREATING THE PROGRAM FILE

To open a new program proceed as follows:

1. Start the **HD32MTLogger** software via the icon on the desktop or selecting the program in the *Delta OHM* folder of the *Programs* menu.
2. Select the *Program Setup* icon in the toolbar.



3. In the window that opens, select *NEW Program*.

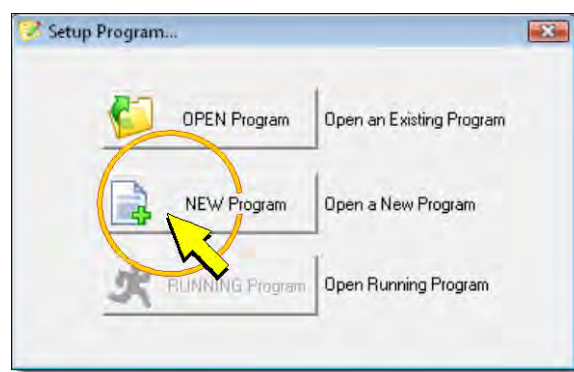

4. Enter a name for the new program in the *Program Name* field.

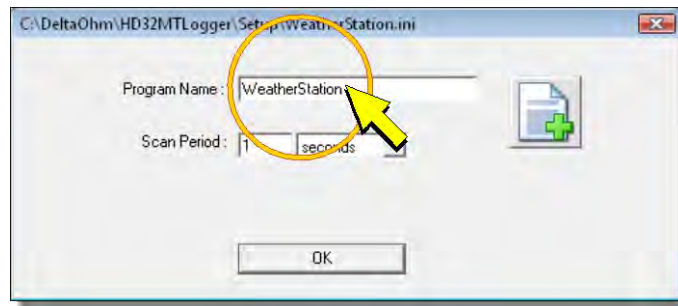

The name must start with a letter and can contain only letters, numbers, the character "_" and the point (but may not be the last character of the name).

5. In the *Scan Period* field, enter the acquisition interval of the sensor measurements (from 1 to 60 seconds).

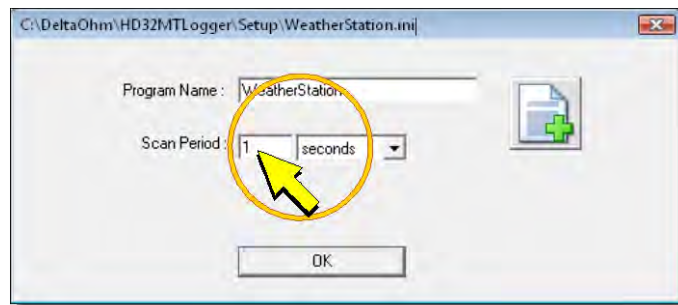

Note: The interval value can be added or changed even after.

6. Press *OK*, the new program window opens.

9.2 LIST OF SENSORS AND SETTING OF PARAMETERS

After opening the measurements and recordings program window, you must define the list of sensors to be connected to the data logger and set the parameters for each sensor.

The measures that you can perform with the data logger are divided into three categories:

- **Universal Measurements**

- *Unipolar Voltage* Measure voltage in single-ended mode
- *Bipolar Voltage* Measure voltage in differential mode
- *Resistance Divider* 2-wire resistance or 3-wire potentiometric measurement
- *ResistanceDivider 4Wire:* 4-wire resistance measurement
- *Adder Pulses* Pulse or potential-free contact switching count
- *Input Current 4-20 and 0-20mA* Current measurements
- *Digital Input* Detection of TTL logic levels
- *Modbus RTU* Acquisition of sensors with RS485 output and Modbus RTU protocol
- *Serial Channels* Acquisition of sensors with RS485 output and proprietary protocol
- *GPS* Detection of GPS data (from the external module)

- **Environmental Analysis**

- *U.S. Anemometers HD2003* Measures of HD2003 and HD2003.1 anemometers
- *U.S. Anemometers HD52.3D* Measures of HD52.3D... series anemometers
- *Rain Gauges* Measure of rain quantity
- *Radiometry* Measure of solar radiation

- **Industry**

- *Pt100-Pt1000 thermometers* Temperature measures with Pt100-Pt1000 probe
- *Thermocouples* Temperature measures with thermocouple probe
- *NTC Thermistors* Temperature measures with NTC thermistors

To add a sensor to the program, proceed as follows:

1. In the list of measurements that can be executed by the data logger, identify the one corresponding to the sensor to be connected (for example *Input Current 4-20 and 0-20mA* in the case of a transmitter with current output, or *Radiometry* in the case of a solar radiation probe).
2. In the program window, make sure that in the left side it is selected the *Sensors* panel (the panel is selected by default when opening the program).

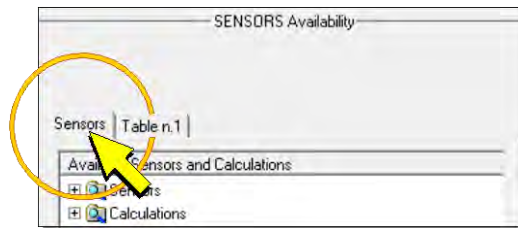

3. Expand the *Sensors* folder and then the folder of the category containing the type of measurement to be added (e.g. *Industry* if you are adding a temperature probe). Then select the type of measure (e.g. *Thermocouples*) and make a click on the *Add Measure* button with the green arrow at the center of the window (or alternatively, double-click on the name of the configuration).

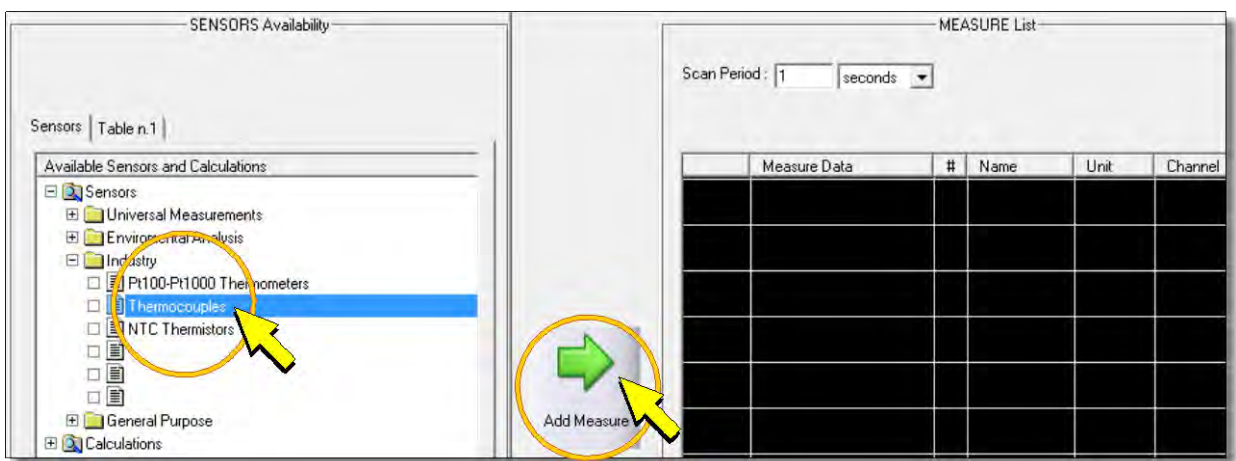

4. The window for sensor configuration appears, in which you can enter all the required parameters.

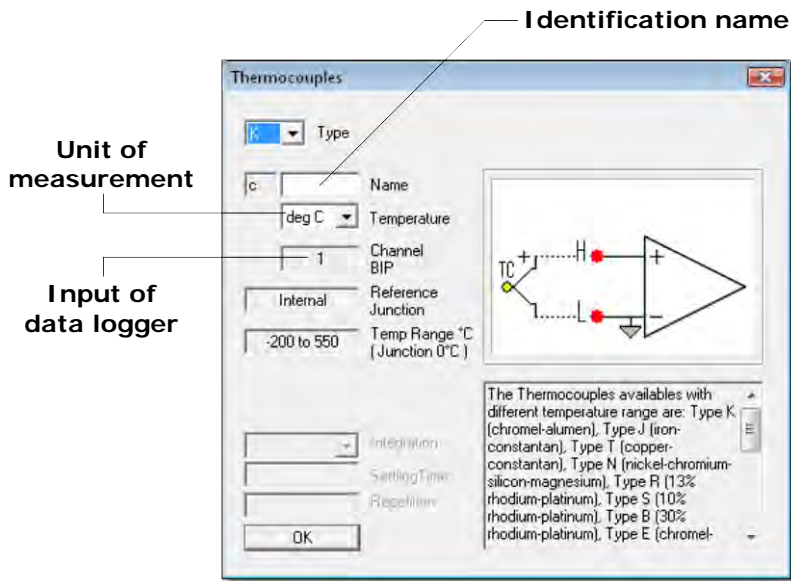

Fill in all editable fields (only the ones with white background) depending on the characteristics of the sensor. All windows have in common three configuration fields:

- o The *Name* field, where you can enter an identifying name for the sensor (for example the model of the sensor, or the type of measured quantity). The name must start with a letter and can be up to 12 alphanumeric characters.
- o The field to indicate the unit of measured quantity. The field is usually positioned just below the *Name* field. Depending on the type of sensor being configured, the unit can be selected from a drop-down list or it can be inserted freely; in the second case must begin with a letter and be no longer than 12 alphanumeric characters.
- o The field indicating the input of the logger to which the sensor must be connected. The input is assigned automatically, you can not change it manually.

The remaining fields depend on the selected sensor. For a full description of parameters for each sensor type, see the following sections (from 9.2.1 to 9.2.16).

Press *OK* to return to the program window.

Note: to cancel the insertion of the sensor, select the tick at the top right.

5. In the right panel of the window (*MEASURE List*) it is displayed the added sensor along with configuration data.

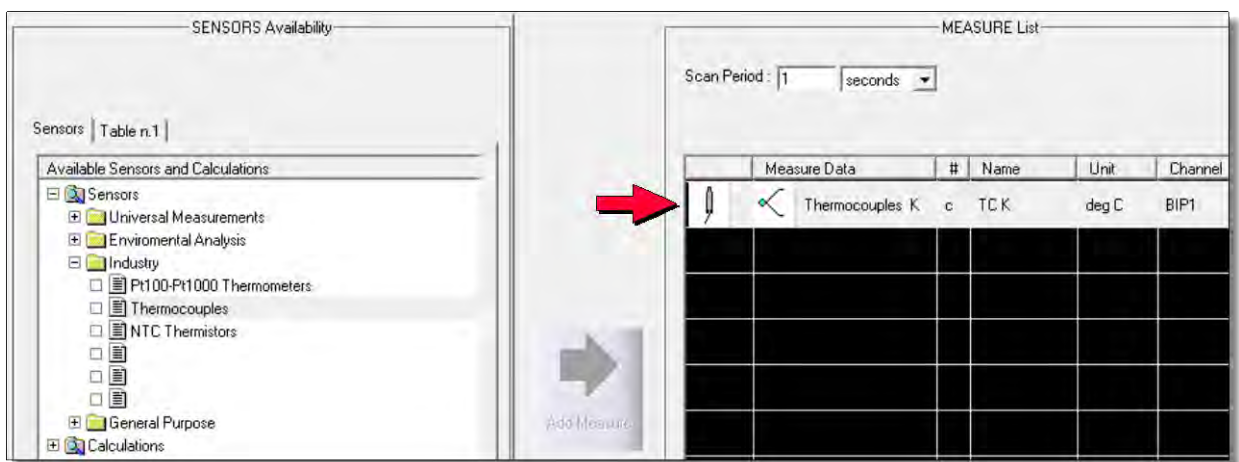

Repeat the procedure for each of the sensors to be connected to the data logger. Each new sensor is appended to the list of sensors already in place.

Note: if a sensor measures more quantities and has multiple outputs, it is necessary to repeat these steps for each output you want to connect (as if they were more separate sensors).

After the insertion of a sensor, you can change the parameters by double clicking on the row of the sensor in the list in the right pane of the window (*MEASURE List*).

Note: double click to change the parameters already entered is active only if in the left pane of the window is selected the *Sensors* panel.

If you want to remove one of the sensors already placed in the right pane, just select it and press the *Remove Measure* button in the lower side of the pane.

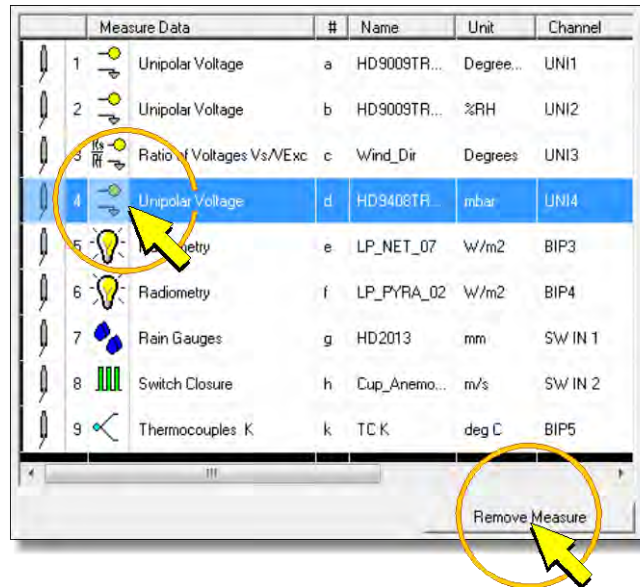

Pressing the *Remove Measure* button prompt to confirm the removal (message: *Do you wish to remove this measure?*), press *Yes* to confirm. If the measure is used in the calculation of derived quantities (see paragraph 9.3), you will get a warning message.

WARNING MESSAGES

When entering the sensors you can get the following messages:

- *Scan Period too short !*

The message appears when the number of sensors becomes too high to be able to acquire all the measures between two successive instants of acquisition. The measure that you are trying to enter will **not** be added to the list of measures. Press *OK* to return to the program window. To insert additional measures it is necessary to increase the acquisition interval in the *Scan Period* field.

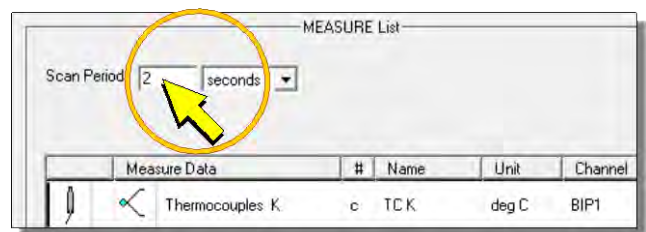

- *The Unipolar Channels n. 1,2 or 3,4 aren't available !*

The message appears when the single-ended inputs 1,2,3 and 4 are already occupied, and you try to insert *NTC Thermistors* and *Resistance Divider* sensor types that can only be connected to these inputs. To insert the sensor it is necessary first to free one of the inputs, deleting the sensor from the list with the command *Remove Measure*.

- *Not other free Channels !*

The message appears when you try to insert a sensor but there are no more inputs available for that type of sensor.

- *Total Measure Data over 30 reached!*

The message appears when you try to insert a sensor but there are already 30 measures present.

Note: when calculating the number of measures take into account that each *Pt100-Pt1000 Thermometers* or *NTC Thermistors* measurement is equivalent to two measures, and if there is at least a *Thermocouples* measure you should add two measures for the cold junction (for the total of all thermocouples).

9.2.1 UNIPOLAR VOLTAGE AND BIPOLAR VOLTAGE CONFIGURATION

In the *Universal Measurements* category, select the item:

- *Unipolar Voltage* to set up a single-ended voltage measurement
- *Bipolar Voltage* for configuring a differential voltage measurement

UNIPOLAR VOLTAGE SELECTION

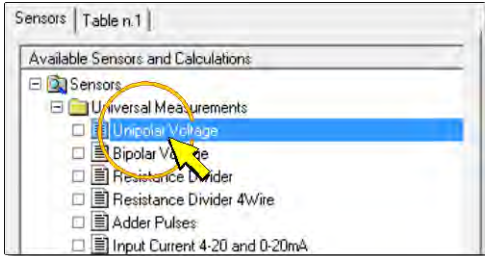

BIPOLAR VOLTAGE SELECTION

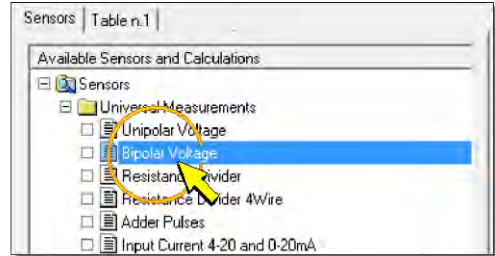

By pressing the *Add Measure* button to add the measure, the configuration window shown below opens. In the figure there is, for reference, also the detail of the terminal board related to the connection scheme that appears in the window (see paragraph 5.3.1 on page 18 for the details of the connections).

UNIPOLAR VOLTAGE WINDOW

Measure Channel Wiring
Name unit UNI diagram

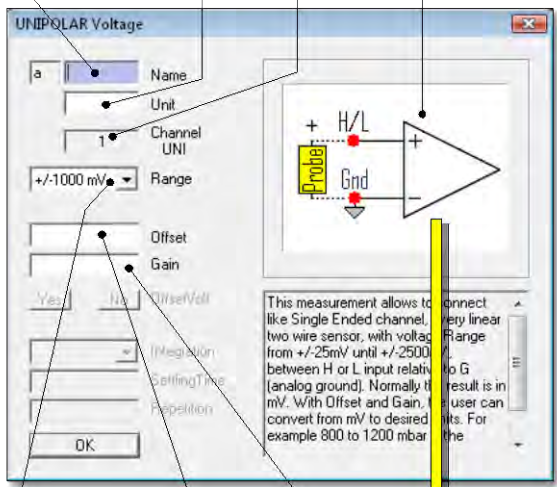

Measurement Offset Gain range

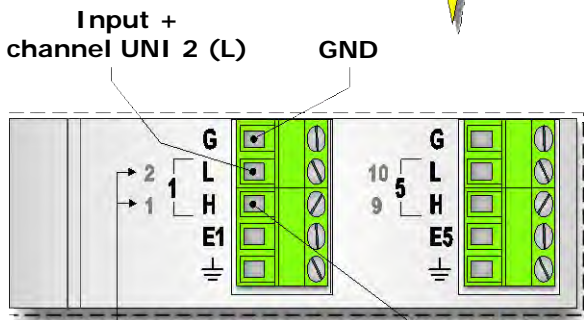

Number single-ended input (UNI)

Input + channel UNI 1 (H)

BIPOLAR VOLTAGE WINDOW

Measure Channel Wiring
Name unit BIP diagram

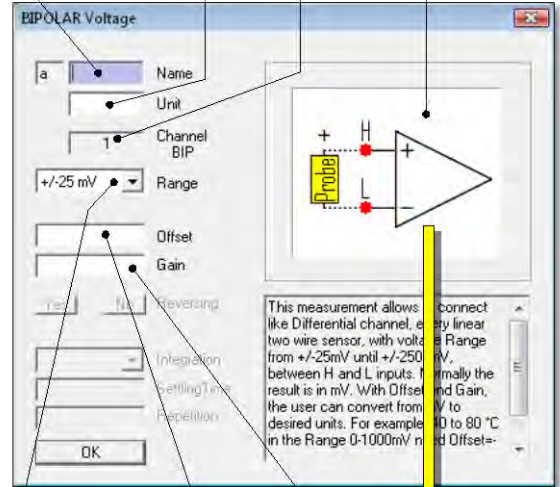

Measurement Offset Gain range

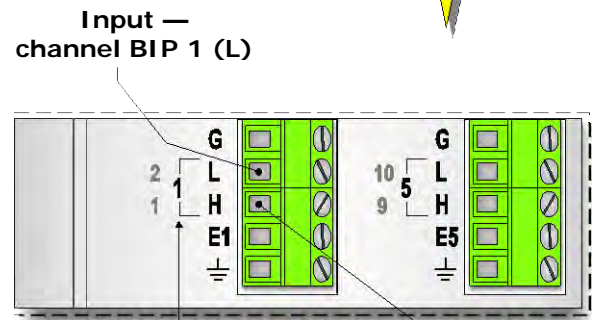

Number differential input (BIP)

Input + channel BIP 1 (H)

In the configuration, you must fill in all fields with white background. The fields in gray are not modifiable. The following describes the fields in the window.

- NAME

Identification name of the sensor. You can assign as the name, for example, the model of the sensor, or the type of measured quantity. The name must start with a letter and can be up to 12 alphanumeric characters.

The name uniquely identifies the measure that you are entering, you can not assign the same name to several measures.

- UNIT (UNIT OF MEASUREMENT)

A measure of the quantity detected by the sensor. It must begin with a letter and can be a maximum of 12 characters.

The unit is inserted in accordance with the values of *Offset* and *Gain* parameters (see the corresponding point below in the paragraph for setting these parameters).

- CHANNEL UNI OR CHANNEL BIP

It Indicates the number of analog input to which the sensor must be connected. The software automatically assigns the first free input. The number is not editable by the user. The location of the analog inputs is given at point **4** of the terminal board figure on page 9.

- RANGE

It is the measuring range of the data logger input. Click on the *Range* field and then select a measuring range suitable for the sensor that is being inserted, so that the voltage sensor output is within the measurement range selected. There are four selectable ranges:

- ±25 mV
- ±100 mV
- ±1000 mV
- ±2500 mV

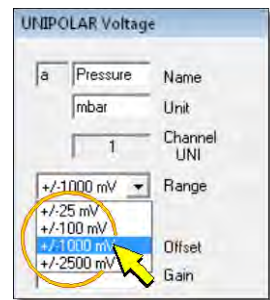

To get the best resolution of measurement it is convenient to choose the first measurement range higher than the output of the sensor.

If the sensor output voltage is too high to fall within the ranges available, it is necessary to reduce the signal by inserting a resistive divider between the output of the sensor and the data logger input (see paragraph 5.3.1 on page 18 for the connections).

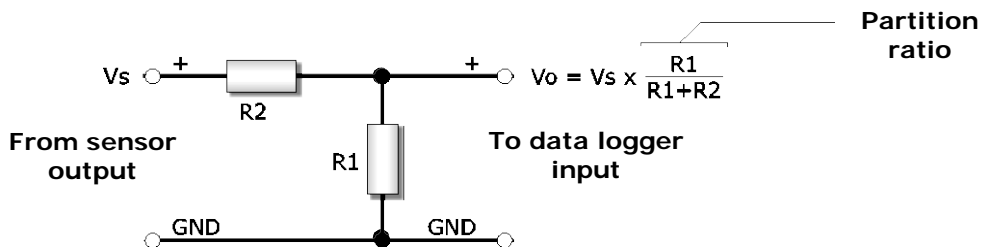

The sum of the values of R1 and R2 must be greater than the minimum load resistance of the sensor.

Only as an example, the table below shows the ranges in mV selectable and the possible need of the divider for the various voltage outputs typically available in Delta OHM sensors.

Sensor Output	Selectable Range (*)	Resistive Divider
0 ÷ 1 V	±1000 mV or ±2500 mV	No
0 ÷ 5 V	±1000 mV or ±2500 mV	Yes, partition ratio 1/5
0 ÷ 10 V	±1000 mV or ±2500 mV	Yes, partition ratio 1/10
1 ÷ 5 V	±1000 mV or ±2500 mV	Yes, partition ratio 1/5
2 ÷ 10 V	±1000 mV or ±2500 mV	Yes, partition ratio 1/10

(*) *Note:* Some sensors can provide an output voltage that exceeds the nominal value of the scale, if the measured quantity exceeds the range measured. If you want that error condition is also recorded by the logger, you must set a value in the *Range* field higher than the nominal range of the sensor. For example, a sensor with a nominal 0-1 V output we have to select the range ±2500 mV and not ±1000 mV.

- OFFSET AND GAIN

The value recorded in the data logger is the result of a linear transformation applied to the value of the input voltage in mV. The transformation is as follows:

$$\text{Value recorded} = \text{Offset} + (\text{Gain} \times \text{Input voltage in mV})$$

By setting *Offset* = 0 and *Gain* = 1, the recorded value is exactly the value of the input voltage in mV.

Generally the voltage in mV corresponds to the value of a physical quantity, such as temperature, humidity, pressure, etc. It is therefore more interesting to directly store the value of the corresponding physical quantity rather than the value in mV. To record directly in the logger the value of the quantity is sufficient to enter in the fields *Offset* and *Gain* the values calculated by the following relations:

$$\text{Offset} = \frac{(\mathbf{G}_{is} \times \mathbf{V}_{fs}) - (\mathbf{G}_{fs} \times \mathbf{V}_{is})}{\mathbf{V}_{fs} - \mathbf{V}_{is}} \qquad \text{Gain} = \frac{\mathbf{G}_{fs} - \mathbf{G}_{is}}{\mathbf{V}_{fs} - \mathbf{V}_{is}} \times \mathbf{K}$$

Where: **G_{is}** = initial scale of the physical quantity

G_{fs} = full scale of the physical quantity

V_{is} = initial scale of the sensor output (in mV)

V_{fs} = full scale of the sensor output (in mV)

K = inverse of the ratio of partition of any resistive divider connected between the sensor output and the input of data loggers (K = 1 if the divider is not present)

The value will be recorded in the same unit of measurement of **G_{is}** and **G_{fs}** values. This unit is one that should be inserted in the *Unit* field of the configuration window.

In the *Offset* and *Gain* fields must be entered only the numerical value without unit.

Using non-zero *Offset* and *Gain* different from 1 produces accurate results only if the sensor output varies **linearly** with the measured physical quantity. Otherwise, the recorded value will be affected by an error which depends on the sensor response. For sensors that have non-linearity that can not be neglected is advisable to set *Offset* = 0 and *Gain* = 1, and just registering the value of the input voltage in mV.

Example 1

Suppose you need to configure a temperature transmitter with 0 to 1 V output and measuring range -40 to +80 °C. The transmitter output is connected directly to the data logger (there are no resistive dividers).

The values needed for the computation of *Offset* and *Gain* are therefore:

$$\mathbf{G_{is}} = -40 \text{ }^{\circ}\text{C} \quad \mathbf{G_{fs}} = +80 \text{ }^{\circ}\text{C} \quad \mathbf{V_{is}} = 0 \text{ mV} \quad \mathbf{V_{fs}} = 1000 \text{ mV} \quad \mathbf{K} = 1$$

The values needed to calculate the *Offset* and *Gain* are:

$$\text{Offset} = \frac{(-40 \times 1000) - (80 \times 0)}{1000 - 0} = -40 \quad \text{Gain} = \frac{80 - (-40)}{1000 - 0} \times 1 = 0,12$$

In the *Unit* field must be indicated degrees Celsius as the unit of measure. Since the maximum length of 12 characters and it is not possible to insert the special symbol "°", the unit can be shortened with "degrees C".

Example 2

Suppose you need to configure a barometric transmitter with 1 to 5V output and measuring range 800 to 1100 mbar. Between the transmitter and data logger is inserted a resistive divider with a partition ratio of 1/5.

The values needed for the computation of *Offset* and *Gain* are therefore:

$$\mathbf{G_{is}} = 800 \text{ mbar} \quad \mathbf{G_{fs}} = 1100 \text{ mbar} \quad \mathbf{V_{is}} = 1000 \text{ mV} \quad \mathbf{V_{fs}} = 5000 \text{ mV} \quad \mathbf{K} = 5$$

The values needed to calculate the *Offset* and *Gain* are:

$$\text{Offset} = \frac{(800 \times 5000) - (1100 \times 1000)}{5000 - 1000} = -725 \quad \text{Gain} = \frac{1100 - 800}{5000 - 1000} \times 5 = 0,375$$

In the *Unit* field mbar must be indicated as the unit of measurement.

9.2.2 RESISTANCE DIVIDER CONFIGURATION

In the *Universal Measurements* category, select *Resistance Divider* to configure a 2-wire resistance or 3-wire potentiometric measurement.

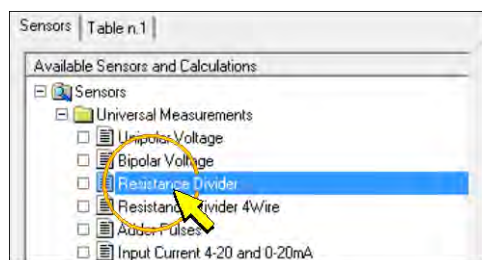

By pressing the *Add Measure* button to add the measure, the configuration window shown below appears. In the figure there is, for reference, also the detail of the terminal board related to the connection scheme that appears in the window (see paragraphs 5.3.3 on page 23 and 5.3.4 on page 24 for the details of the connections).

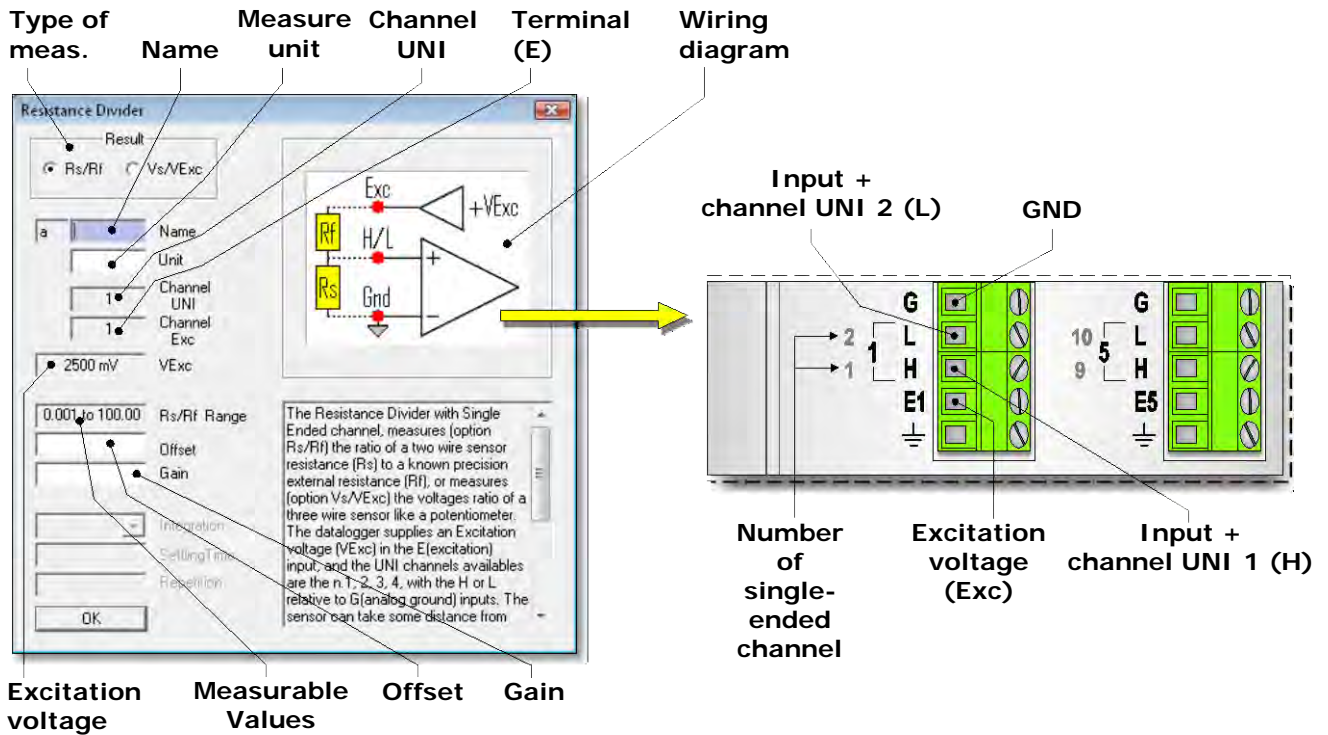

In the upper left corner of the configuration window there is the box to choose the type of measure. select:

- *Rs/Rf* to set up a 2-wire resistance measurement.
With this option the data logger measures the value of resistance R_s provided by the sensor compared to the reference R_f resistance value.
- *Vs/VExc* to set up a 3-wire potentiometric measurement.
With this option the data logger measures the voltage V_s at the input compared to the value of excitation voltage V_{Exc} .

At the opening of the window is selected by default *Rs/Rf* option. Selecting the *Vs/VExc* option, the window shows the wiring diagram for a potentiometric sensor, as shown below:

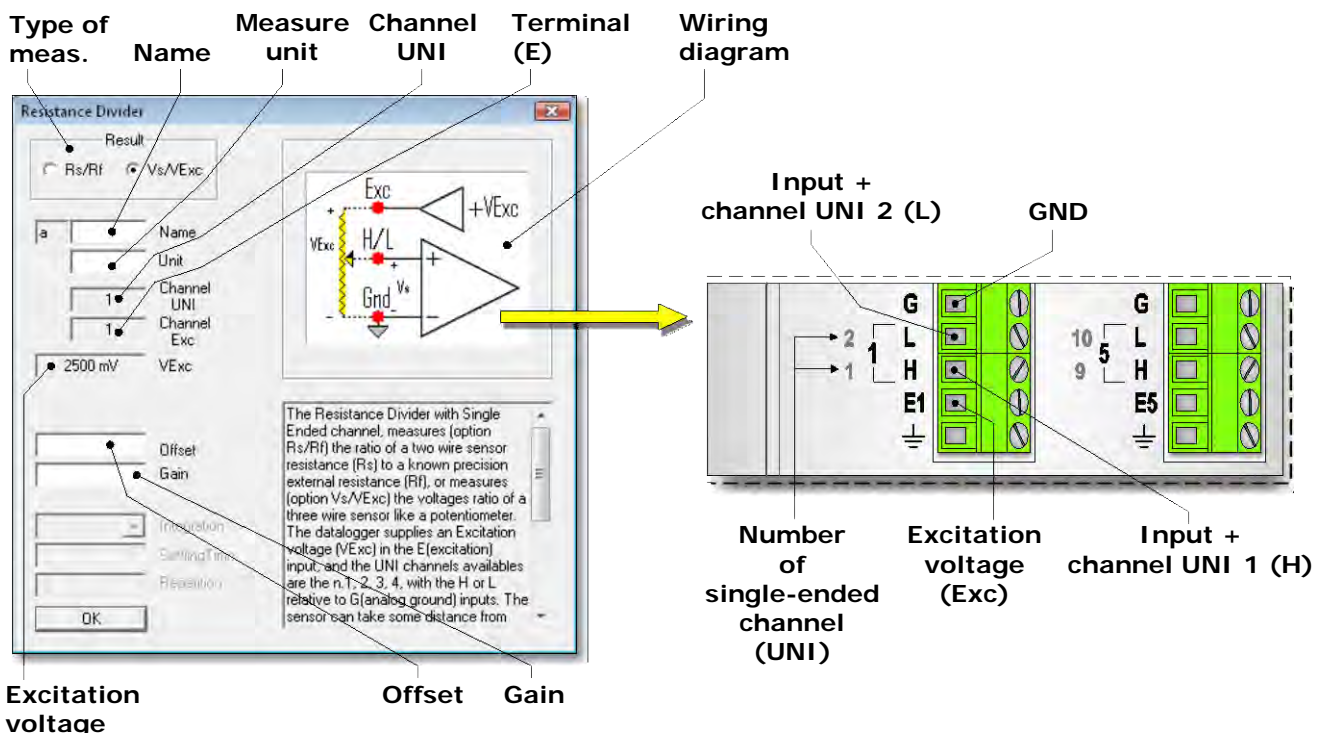

In the configuration, you must fill in all fields with white background. The fields in gray are not modifiable. The following describes the fields in the window.

- NAME

Identification name of the sensor. You can assign as the name, for example, the model of the sensor, or the type of measured quantity. The name must start with a letter and can be up to 12 alphanumeric characters.

The name uniquely identifies the measure that you are entering, you can not assign the same name to several measures.

- UNIT (UNIT OF MEASUREMENT)

Unit of measurement of the quantity detected by the sensor. It must begin with a letter and can be a maximum of 12 alphanumeric characters.

The unit is inserted in accordance with the values of *Offset* and *Gain* parameters (see the corresponding point below in the paragraph for setting these parameters).

- CHANNEL UNI

Indicates the number of analog input to which the sensor must be connected. The software automatically assigns the first free input. The number is not editable by the user. The location of the analog inputs is given at point 4 of the terminal board figure on page 9.

The programmable inputs for this type of measurement are only the single-ended inputs 1, 2, 3 and 4.

- CHANNEL EXC (EXCITATION TERMINAL)

Indicates the number of the terminal **E** which from where the excitation voltage must be taken, which is the terminal where you must connect one end of the reference resistor **Rf** or potentiometer. The number is assigned automatically and is not editable by the user.

- VEXC (EXCITATION VOLTAGE)

It is the excitation voltage applied to terminal **E**. The value is fixed at 2500 mV.

- Rs/Rf RANGE

The field appears only if you selected *Rs/Rf*, and indicates the range of measurement of the resistance *Rs* of the sensor compared to the reference resistance value *Rf*. The field can not be set. The measuring range of *Rs* depends only on the value of the reference resistance *Rf*. The minimum and maximum values measurable are respectively:

$$R_{S_{\min}} = R_f / 1000$$

$$R_{S_{\max}} = 100 \times R_f$$

It is recommended that *Rf* is neither too small nor too large compared to the values that can assumed by the sensor, otherwise there would be a small change in voltage across *Rs* and therefore a low resolution. The *Rf* values should be between the minimum ($R_{S_{\min}}$) and maximum ($R_{S_{\max}}$) of *Rs*. The *Rf* values that maximizes the change in voltage across *Rs* and allows the best resolution is given by the following relation:

$$R_f = \sqrt{R_{S_{\min}} \times R_{S_{\max}}}$$

The reference resistor *Rf* must be a precision resistor and sufficiently stable over time and exposure to environmental conditions, since the drift of the *Rf* values results in a measurement change that this is not due to a real variation of the physical quantity measured.

- OFFSET AND GAIN

The value recorded in the data logger is the result of a linear transformation applied to the measured value.

If you select the *Rs/Rf* measurement type, the transformation is:

$$\text{Value recorded} = \text{Offset} + (\text{Gain} \times \text{Rs/Rf})$$

If you select the type of measurement *Vs/VExc*, the formula is:

$$\text{Value recorded} = \text{Offset} + (\text{Gain} \times \text{Vs/VExc})$$

By setting *Offset* = 0 and *Gain* = 1, the recorded value is *Rs/Rf* or *Vs/VExc* depending on the type of measurement selected.

Generally, the measured value corresponds to the value of a physical quantity, such as temperature, wind direction, etc.. It is therefore more interesting to store directly the value of the physical quantity. To record directly in the logger the value of the quantity is sufficient to enter in the fields *Offset* and *Gain* the values calculated by the following relations:

$$\text{Offset} = \frac{(\mathbf{G}_{is} \times \mathbf{V}_{fs}) - (\mathbf{G}_{fs} \times \mathbf{V}_{is})}{\mathbf{V}_{fs} - \mathbf{V}_{is}} \qquad \text{Gain} = \frac{\mathbf{G}_{fs} - \mathbf{G}_{is}}{\mathbf{V}_{fs} - \mathbf{V}_{is}}$$

Where: **G_{is}** = initial scale of the physical quantity

G_{fs} = full scale of the physical quantity

V_{is} = value of *Rs/Rf* or *Vs/VExc* at initial scale (dimensionless value)

V_{fs} = value of *Rs/Rf* or *Vs/VExc* at full scale (dimensionless value)

The value will be recorded in the same unit of measurement of **G_{is}** and **G_{fs}** values. This unit is the one that should be inserted in the *Unit* field of the configuration window.

In the *Offset* and *Gain* fields must be entered only the numerical value without unit.

Using non-zero *Offset* and *Gain* different from 1 produces accurate results only if the sensor output varies **linearly** with the measured physical quantity. Otherwise, the recorded value will be affected by an error which depends on the sensor response. For sensors that have non-linearity that can not be neglected it is advisable to set *Offset* = 0 and *Gain* = 1, and just registering the value measured without applying transformations.

Example

Suppose you need to configure a vane sensor for wind direction with potentiometric output, whose measurement range is 2 to 357°.

The sensor has a dead band of 5° not symmetric around the reference direction (0°). It is assumed that the potentiometer is at minimum (0 ohm ⇒ *Vs* = 0) when the measurement is 2°, and is instead at maximum (*Vs* = *VExc*) when the measure is 357°. To calculate the *Offset* and *Gain* is not important the absolute value of the potentiometer in ohm.

The values needed to calculate the *Offset* and *Gain* are therefore.

$$\mathbf{G}_{is} = 2^\circ \qquad \mathbf{G}_{fs} = 357^\circ \qquad \mathbf{V}_{is} = 0 \qquad \mathbf{V}_{fs} = 1$$

The values of the parameters to be included in the configuration window are:

$$\text{Offset} = \frac{(2 \times 1) - (357 \times 0)}{1 - 0} = 2 \qquad \text{Gain} = \frac{357 - 2}{1 - 0} = 355$$

In the field *Unit* must be indicated degrees as unit of measurement.

Note: in the particular case that the sensor has a dead band *D* symmetrical to the reference direction, we get *Offset* = *D*/2 and *Gain* = 360° - *D*.

9.2.3 RESISTANCE DIVIDER 4-WIRE CONFIGURATION

In the *Universal Measurements* category, select *4 Wire Resistance Divider 4-Wire* for setting up a 4-wire resistance measurement.

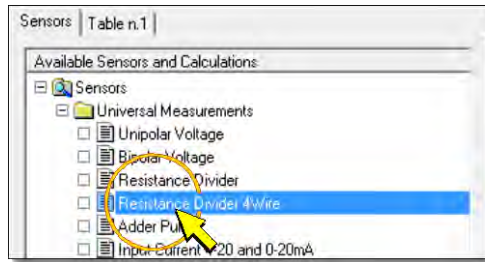

By pressing the *Add Measure* button to add the measure, the configuration window shown below appears. In the figure there is, for reference, also the detail of the terminal board related to the connection scheme that appears in the window (please see the paragraph 5.3.5 on page 24 for the details of the connections).

Measure Name	unit	Channel BIP	Measurement range	Wiring diagram
Resistance Divider 4Wire	a	1	+/-100 mV	

Reference voltage: 2500 mV
Internal resistance: 6375 Ohm
Gain: 1
Offset: 0

Input — channel BIP 1 (L): 2, 1
Excitation voltage (Exc): 10, 9
Input + channel BIP 1 (H): 5, 4

In the configuration window, you must fill in all fields with white background. The fields in gray are not modifiable. The following describes the fields in the window.

- **NAME**

Identification name of the sensor. You can assign as the name, for example, the model of the sensor, or the type of measured quantity. The name must start with a letter and can be up to 12 alphanumeric characters.

The name uniquely identifies the measure that you are entering, you can not assign the same name to several measures.

- **UNIT (UNIT OF MEASUREMENT)**

Unit of measurement of the quantity detected by the sensor. It must begin with a letter and can be a maximum of 12 alphanumeric characters.

The unit is inserted in accordance with the values of *Offset* and *Gain* parameters (see the corresponding point below in the paragraph for setting these parameters).

- CHANNEL BIP,Exc

Indicates the number of analog input to which the sensor must be connected. The software automatically assigns the first free input. The number is not editable by the user. The location of the analog inputs is given at point 4 of the terminal board figure on page 9.

- RANGE

It is the measuring range in mV of data logger input. Click on the *Range* field and then select a measuring range suitable for the sensor that is being inserted, so that the voltage at the data logger input is within the measuring range selected. There are three selectable ranges:

- ±100 mV
- ±1000 mV
- ±2500 mV

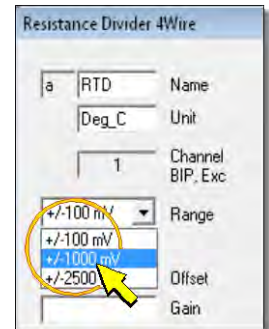

To get the best resolution of measurement it is convenient to choose the first measurement range higher than the maximum voltage drop V_{Smax} on the resistance R_s to be measured, given by the relation.

$$V_{Smax} = V_{Ref} \times \frac{R_{Smax}}{R_{Smax} + R_{fint}} \quad (V_{Ref} = 2500 \text{ mV and } R_{fint} = 6375 \text{ ohm are fixed values})$$

- VREF (REFERENCE VOLTAGE)

It is the reference voltage applied to the divider comprising the sensor resistance and the internal resistance R_f of the data logger. The value is fixed at 2500 mV.

- RF INT (RF INTERNAL RESISTANCE)

It is the internal resistance of the logger, interposed between terminal **E** and the internal reference voltage. The value is fixed at 6375 ohm.

- OFFSET AND GAIN

The value recorded in the data logger is the result of a linear transformation applied to the measured value. The formula is the following:

$$\text{Value recorded} = \text{Offset} + (\text{Gain} \times R_s)$$

By setting *Offset* = 0 and *Gain* = 1, the recorded value is exactly the value of the resistance R_s offered by the sensor.

Generally, the measured value corresponds to the value of a physical quantity, e.g. temperature. It is therefore more interesting to store directly the value of the physical quantity rather than the resistance value measured. To record directly in the logger the value of the quantity is sufficient to enter in the fields *Offset* and *Gain* the values calculated by the following relations:

$$\text{Offset} = \frac{(G_{is} \times V_{fs}) - (G_{fs} \times V_{is})}{V_{fs} - V_{is}} \qquad \text{Gain} = \frac{G_{fs} - G_{is}}{V_{fs} - V_{is}}$$

Where: **G_{is}** = initial scale of the physical quantity

G_{fs} = full scale of the physical quantity

V_{is} = resistance value R_s of the sensor initial scale (in ohm)

V_{fs} = resistance value R_s of the sensor full scale (in ohm)

The value will be recorded in the same unit of measurement of **G_{is}** and **G_{fs}** values. This unit is one that should be inserted in the *Unit* field of the configuration window.

In the *Offset* and *Gain* fields must be entered only the numerical value without unit.

Using non-zero *Offset* and *Gain* different from 1 produces accurate results only if the sensor output varies **linearly** with the measured physical quantity, otherwise the recorded value will be affected by an error which depends on the sensor response. For sensors that have non-linearity that can not be neglected is advisable to set *Offset* = 0 and *Gain* = 1, and simply recording the measured resistance value.

Example

Suppose you need to configure a resistive temperature sensor, whose measuring range is -50 to 200 °C. The values of sensor resistance at initial and full scale are respectively 80.31 ohm and 175.86 ohm.

The values needed to calculate the *Offset* and *Gain* are therefore:

$$G_{is} = -50 \text{ °C} \quad G_{fs} = 200 \text{ °C} \quad V_{is} = 80.31 \text{ ohm} \quad V_{fs} = 175.86 \text{ ohm}$$

The values of the parameters to be included in the configuration window are:

$$Offset = \frac{((-50) \times 175.86) - (200 \times 80.31)}{175.86 - 80.31} = -260.125 \quad Gain = \frac{200 - (-50)}{175.86 - 80.31} = 2.616$$

In the field *Unit* must be indicated degrees Celsius as the unit of measurement. Since the maximum length is 12 characters and it is not possible to insert the special symbol "°", the unit can be shortened with "degrees C".

9.2.4 ADDER PULSES → DIGITAL/ANALOG PULSES CONFIGURATION

To configure the digital or analog high-frequency pulse counting (up to 100 KHz), select the item *Adder Pulses* in the category *Universal Measurements*.

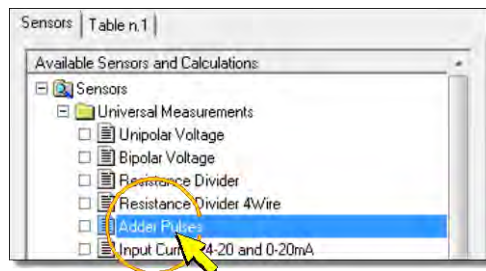

By pressing the *Add Measure* button to add the measurement, the window for the selection of the type of pulses to be counted appears. Select the *Digital/Analog Pulses* option.

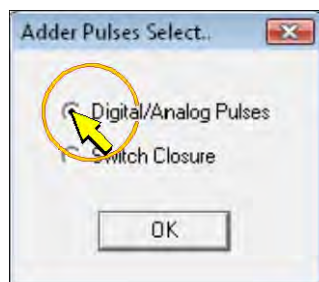

Press *OK* to confirm, the configuration window shown below appears. In the figure there is, for reference, also the detail of the terminal board related to the connection scheme that appears in the window (see section 5.5.1 on page 26 for details of the connections).

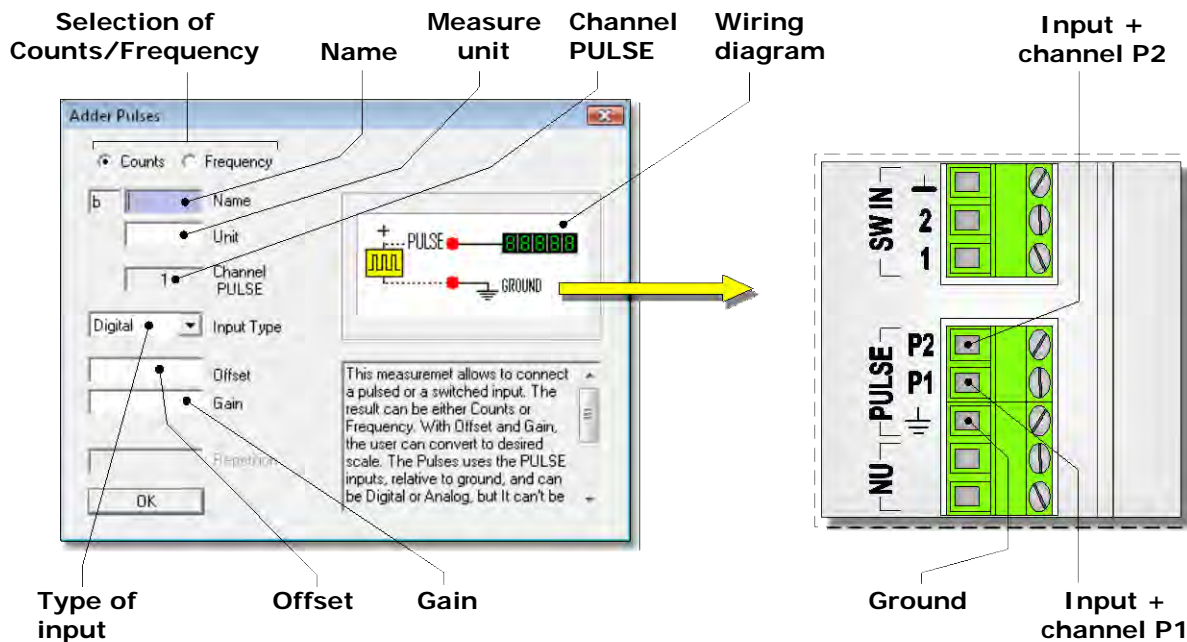

In the top left of the configuration window select the option:

- *Counts* to acquire the number of pulses received during the acquisition interval (*Scan Period*).
- *Frequency* to acquire the frequency (in Hz) of the input signal. The frequency is calculated in the interval of acquisition (*Scan Period*).

Note: The pulse count is reset at the beginning of each acquisition interval (*SCAN Period*). To store the total number of pulses received in N successive acquisition intervals, insert the quantity in a store table selecting *Total* as value to be stored, and setting the recording interval (*STORE Period*) equal to N times the acquisition interval (see paragraph 0 on page 100).

In the configuration, you must fill in all fields with white background. The fields in gray are not modifiable. The following describes the fields in the window.

- NAME
Identification name of the sensor. You can assign the name, for example, of the sensor model, or the type of measured quantity. The name should begin with a letter and can be maximum 12 alphanumeric characters long.

The name unequivocally identifies the measurement being input; you cannot assign the same name to multiple measurements.

- UNIT (UNIT OF MEASUREMENT)
Unit of measurement of the quantity detected by the sensor. It must begin with a letter and can be a maximum of 12 alphanumeric characters.

The unit is inserted in accordance with the values of *Offset* and *Gain* parameters (see the corresponding point below in the paragraph for setting these parameters).

- CHANNEL PULSE
Indicates the number of the PULSE input to which the sensor must be connected. The software automatically assigns the first free input. The number is not editable by the user. The location of the PULSE inputs is indicated at the point **8** of the terminal board figure on page 9.

- INPUT TYPE

Select the *Digital* option if the output signal of the sensor is digital, or *Analog*, if it is analog.

In both cases the threshold voltages levels for the recognition of the pulse correspond to the values of the standard TTL logic.

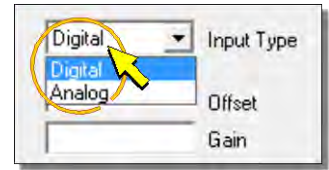

- OFFSET AND GAIN

The value recorded in the data logger is the result of a linear transformation applied to the measured value.

If you select the *Counts* type of measurement, the formula is:

$$\text{Value recorded} = \text{Offset} + (\text{Gain} \times \text{Count})$$

If you select the *Frequency* type of measurement, the formula is:

$$\text{Value recorded} = \text{Offset} + (\text{Gain} \times \text{Frequency})$$

By setting $\text{Offset} = 0$ and $\text{Gain} = 1$, the recorded value is exactly the value of the count or frequency.

Generally, the measured value corresponds to the value of a physical quantity, e.g. flow rate, wind speed, etc. It is therefore more interesting to store directly the value of the physical rather than the measured value. To record directly in the logger the value of the quantity it is sufficient to enter in the fields *Offset* and *Gain* the values calculated by the following relations:

$$\text{Offset} = \frac{(\mathbf{Gis} \times \mathbf{Vfs}) - (\mathbf{Gfs} \times \mathbf{Vis})}{\mathbf{Vfs} - \mathbf{Vis}} \qquad \text{Gain} = \frac{\mathbf{Gfs} - \mathbf{Gis}}{\mathbf{Vfs} - \mathbf{Vis}}$$

Where:

Gis = initial scale of the physical quantity

Gfs = full scale of the physical quantity

Vis = value of the count or frequency relative to the initial scale of the quantity

Vfs = value of the count or frequency relative to the full scale of the quantity

The value will be recorded in the same unit of measurement of **Gis** and **Gfs** values. This unit is one that should be inserted in the *Unit* field of the configuration window.

In the *Offset* and *Gain* fields must be entered only the numerical value without unit.

Example

Suppose you need to configure a cup anemometer with frequency digital output. The measuring range is 0 to 70 m/s. The values of the output frequency at the initial and full scale are respectively 0 and 700 Hz.

The input is configured to measure the frequency of the signal (*Frequency* option).

The values needed to calculate the *Offset* and *Gain* are therefore:

$$\mathbf{Gis} = 0 \qquad \mathbf{Gfs} = 70 \text{ m/s} \qquad \mathbf{Vis} = 0 \qquad \mathbf{Vfs} = 700 \text{ Hz}$$

The values of the parameters to be included in the configuration window are:

$$\text{Offset} = \frac{(0 \times 700) - (70 \times 0)}{70 - 0} = 0 \qquad \text{Gain} = \frac{70 - 0}{700 - 0} = 0.1$$

In the field *Unit*, must be indicated m/s as unit.

9.2.5 ADDER PULSES → SWITCH CLOSURE CONFIGURATION

To set the count of the number of opening/closing of a potential-free contact, for example, the contact of a relay, select the *Adder Pulses* item in the category *Universal Measurements*.

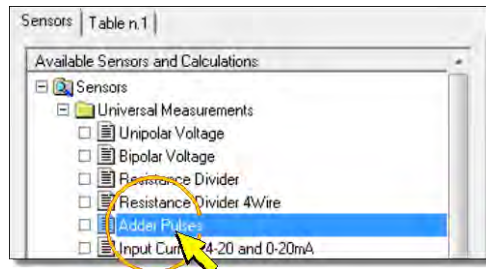

By pressing the *Add Measure* button to add the measurement, appears the dialog for selecting the type of pulses to be counted. Select the *Switch Closure* option.

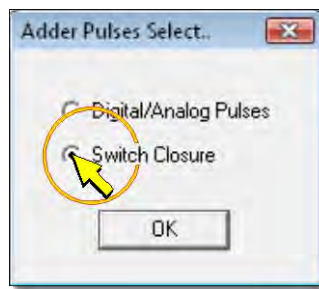

Press *OK* to confirm, so the configuration window shown below appears. In the figure there is, for reference, also the detail of the terminal board related to the connection scheme that appears in the window (see paragraph 5.5.2 on page 27 for details of the connections).

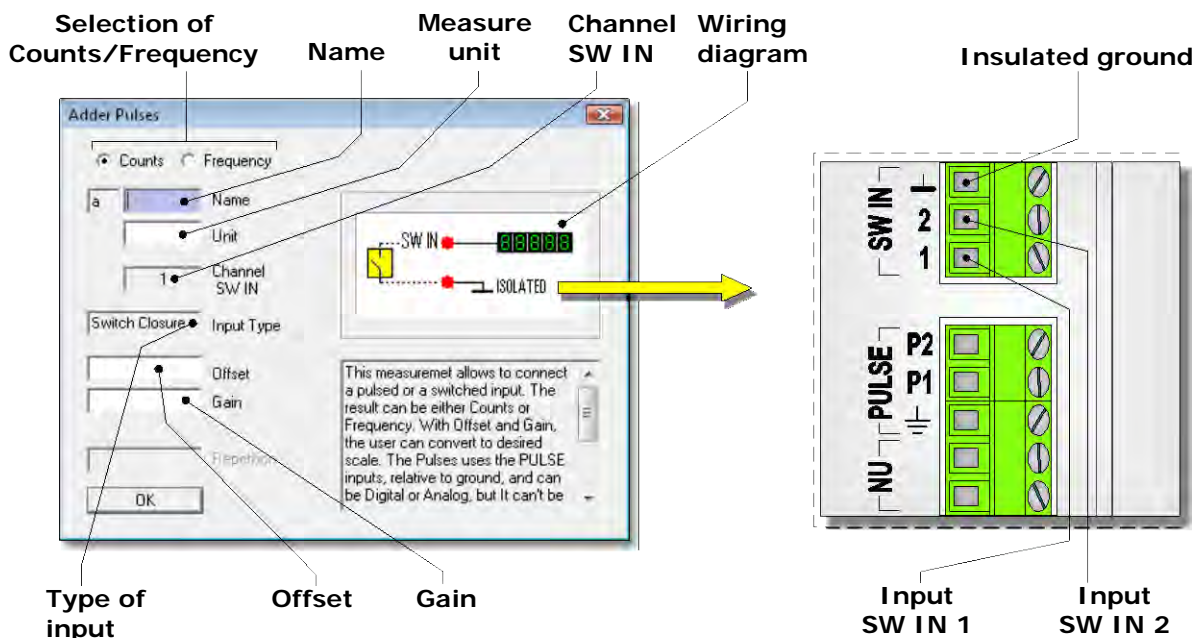

Select the option up on the left in the configuration window:

- *Counts* to acquire the number of openings / closings during an acquisition interval (*Scan Period*).
- *Frequency* to acquire the frequency (in Hz) of the switching contact. The frequency is calculated in the interval of acquisition (*Scan Period*).

Note: The count of the opening/closing is reset at the beginning of each acquisition interval (*SCAN Period*). To store the total number of openings/closures in N intervals of acquisition, insert the measure in a store table selecting the *Total* option as value to be stored, and setting the recording interval (*STORE Period*) equal to N times the acquisition interval (see paragraph 0 on page 100).

In the configuration, you must fill in all fields with white background. The fields in gray are not modifiable. The following describes the fields in the window.

- NAME

Identification name of the sensor. You can assign as the name, for example, the model of the sensor, or the type of measured quantity. The name must start with a letter and can be up to 12 alphanumeric characters.

The name uniquely identifies the measure that you are entering, you can not assign the same name to several measures.

- UNIT (UNIT OF MEASUREMENT)

Unit of measurement of the quantity detected by the sensor. It must begin with a letter and can be a maximum of 12 alphanumeric characters.

The unit is inserted in accordance with the values of *Offset* and *Gain* parameters (see the corresponding point below in the paragraph for setting these parameters).

- CHANNEL SW IN

Indicates the number of the SW IN input to which the sensor must be connected. The software automatically assigns the first free input. The number is not editable by the user. The SW IN inputs arrangement is shown at point 9 of the terminal board figure on page 9.

- INPUT TYPE

The setting is fixed to *Switch Closure*. The maximum detectable switching frequency is 50 Hz.

- OFFSET AND GAIN

The value recorded in the data logger is the result of a linear transformation applied to the measured value.

If you select the *Counts* type of measure the transformation is:

$$\text{Value recorded} = \text{Offset} + (\text{Gain} \times \text{Count})$$

If you select the *Frequency* type of measurement, the formula is:

$$\text{Value recorded} = \text{Offset} + (\text{Gain} \times \text{Frequency})$$

By setting *Offset* = 0 and *Gain* = 1, the recorded value is exactly the value of the count or frequency.

Generally, the measured value corresponds to the value of a physical quantity, such as wind speed, the amount of rain, etc. It is therefore more interesting to store directly the value of the physical quantity rather than the measured value. To record directly in the logger the value of the quantity it is sufficient to enter in the fields *Offset* and *Gain* the values calculated by the following relations:

$$\text{Offset} = \frac{(\mathbf{G_{is}} \times \mathbf{V_{fs}}) - (\mathbf{G_{fs}} \times \mathbf{V_{is}})}{\mathbf{V_{fs}} - \mathbf{V_{is}}} \qquad \text{Gain} = \frac{\mathbf{G_{fs}} - \mathbf{G_{is}}}{\mathbf{V_{fs}} - \mathbf{V_{is}}}$$

Where:

Gis = initial scale of the physical quantity

Gfs = full scale of the physical quantity

Vis = value of the count or frequency relative to the initial scale of the quantity

Vfs = value of the count or frequency relative to the full scale of the quantity

The value will be recorded in the same unit of measurement of **Gis** and **Gfs** values. This unit is one that should be inserted in the *Unit* field of the configuration window.

In the *Offset* and *Gain* fields must be entered only the numerical value without unit.

Example

Suppose you need to set up a tipping bucket rain gauge with voltage-free ON/OFF contact output. The resolution of this sensor is 0.2 mm/switching.

The input is configured to capture the number of pulses (*Counts* option).

In this case, the full scale of measurement of the sensor is not a finite value, since the bucket can switch indefinitely. For the calculation of *offset* and *slope* is therefore necessary to use, instead of the full scale values, intermediate defined values, for example, the values corresponding to 1 count. In the case of rain gauge, 1 count corresponds to the capacity of the bucket at the time of switching (0.2 mm). The initial scale is equivalent to the empty bucket and zero counts.

The values needed for the computation of *Offset* and *Gain* are therefore:

$$\mathbf{Gis} = 0$$

$$\mathbf{Gfs} = 0.2 \text{ mm}$$

$$\mathbf{Vis} = 0$$

$$\mathbf{Vfs} = 1 \text{ count}$$

- o The values of the parameters to be inserted in the configuration window are:

$$\text{Offset} = \frac{(0 \times 1) - (0.2 \times 0)}{1 - 0} = 0$$

$$\text{Gain} = \frac{0.2 - 0}{1 - 0} = 0.2$$

In the *Unit* field, mm must be indicated as the unit.

9.2.6 INPUT CURRENT 4-20 AND 0-20mA CONFIGURATION

In the *Universal Measurements* category, select the *Input Current 4-20 and 0-20mA* item to configure an input for current measurements.

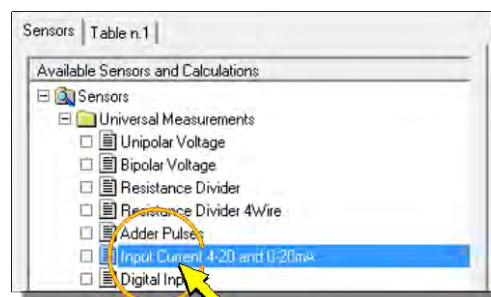

By pressing the *Add Measure* button to add the measurement, the configuration window shown below appears. In the figure there is, for reference, also the detail of the terminal board related to the connection scheme that appears in the window (see the paragraph 5.3.2 on page 21 for the details of the connections).

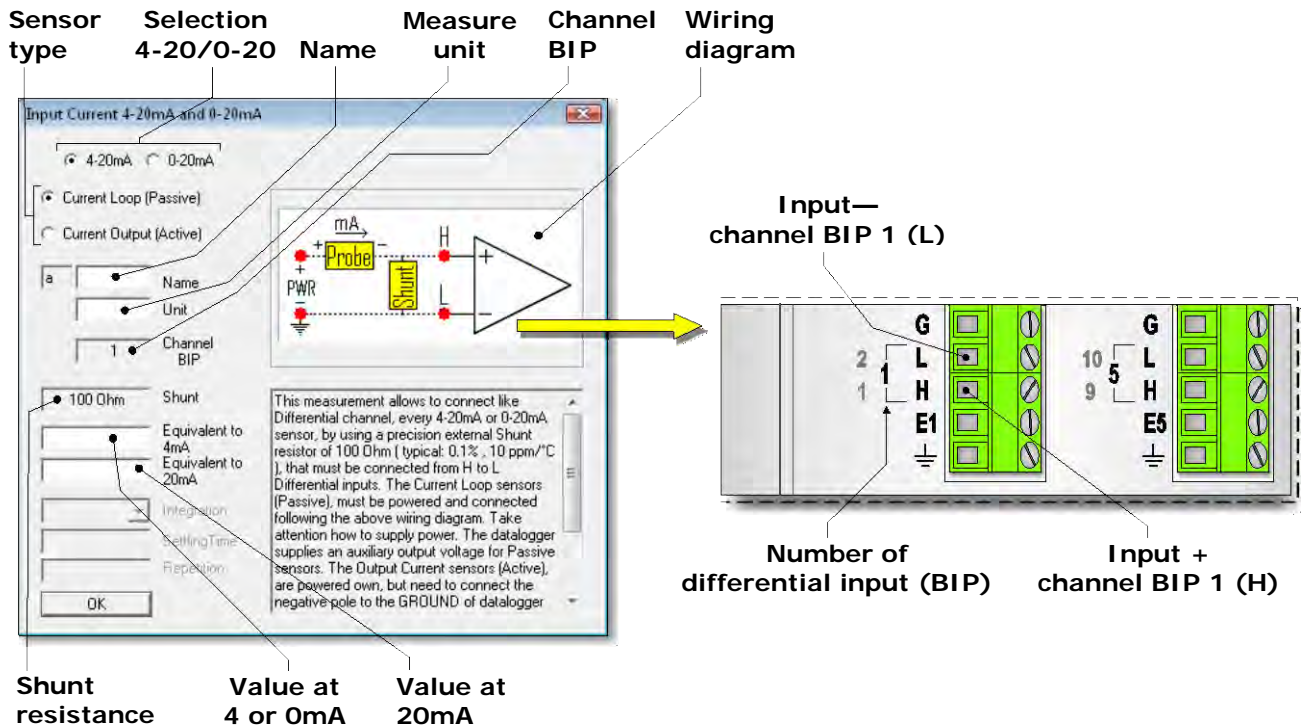

- In the top left of the configuration window, select *4-20mA* or *0-20mA* depending on the current output range of the sensor.
- Depending on the type of sensor select:
 - *Current Loop (Passive)* if the sensor has 2 wires with power on the same line as the signal.
 - *Current Output (Active)* if the sensor has 3 or 4 wires with power supply separate from the signal.

At the opening of the window it is selected by default the *Current Loop (Passive)* option. Selecting the *Output Current (Active)* option, the connection scheme presented in the window changes:

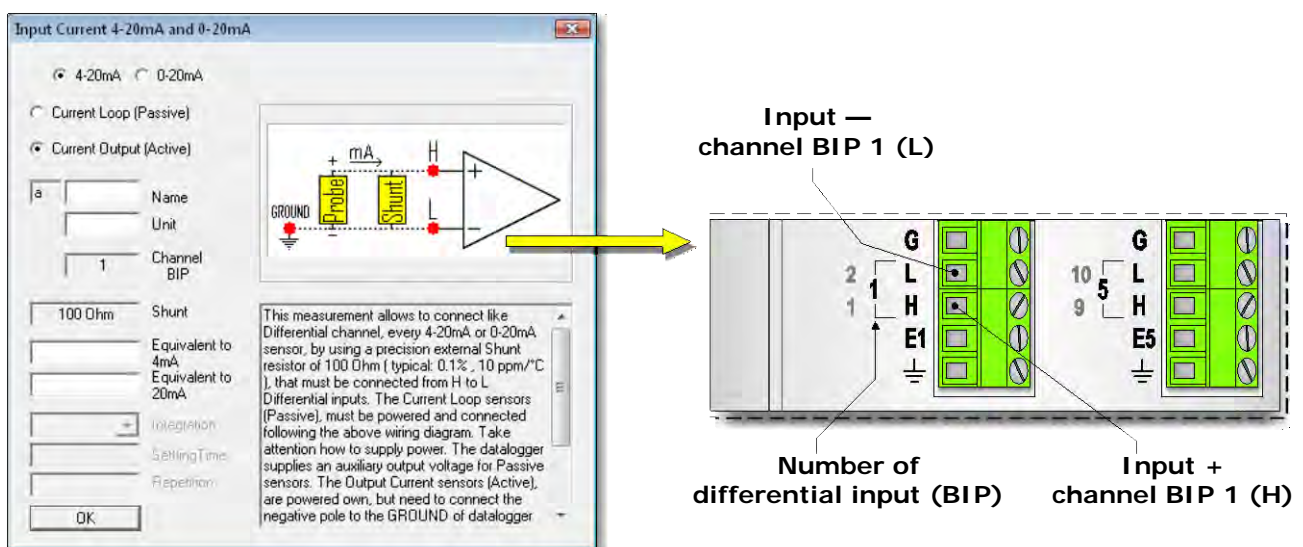

In the configuration window, you must fill in all fields with white background. The fields in gray are not modifiable. The following describes the fields in the window.

- NAME

Identification name of the sensor. You can assign as the name, for example, the model of the sensor, or the type of measured quantity. The name must start with a letter and can be up to 12 alphanumeric characters.

The name uniquely identifies the quantity that you are entering, you can not assign the same name to several measures.

- UNIT (UNIT OF MEASUREMENT)

Unit of measurement of the quantity detected by the sensor. It must begin with a letter and can be a maximum of 12 alphanumeric characters.

The unit is inserted in accordance with the values of parameters *Equivalent to 4mA (or 0mA)* and *Equivalent to 20mA* (see the corresponding point below in the paragraph for setting these parameters).

- CHANNEL BIP

It indicates the number of the analog input to which the sensor should be connected. The software automatically assigns the first free input. The number cannot be changed by the user. The analog inputs arrangement is shown at point 4 of the terminal board figure on page 9.

- SHUNT (SHUNT RESISTANCE VALUE)

The shunt resistor value is fixed at 100 ohm.

- EQUIVALENT TO 4mA OR 0mA AND EQUIVALENT TO 20mA

Generally, the value measured corresponds to the value of a physical quantity, such as temperature, humidity, pressure, etc. It is therefore more interesting to store directly the value of the physical quantity. To record the value of the quantity directly into the data logger, simply enter in the fields *Equivalent to 4mA (or 0mA)* and *Equivalent to 20mA* the following values::

Equivalent to 4mA (or 0mA) = initial scale of the physical quantity

Equivalent to 20mA = full scale of the physical quantity

The recorded value will use the same unit of measurements of the initial and full scale values entered. Such unit of measurement should be entered in the *Unit* field of the configuration window.

You should only enter the numeric value, without unit of measurement, in the *Equivalent to 4mA (or 0mA)* and *Equivalent to 20mA* fields.

Example

Suppose you need to configure a relative humidity transmitter with output 4 to 20 mA, whose measurement range is 0 to 100%.

The values to be entered in the *Equivalent to 4mA* and *Equivalent to 20mA* are simply:

Equivalent to 4mA = 0

Equivalent to 20mA = 100

In the *Unit* field, % must be indicated as unit of measurement.

9.2.7 DIGITAL INPUT CONFIGURATION

In the *Universal Measurements* category, select the *Digital Input* item to configure an input for the detection of TTL logic levels.

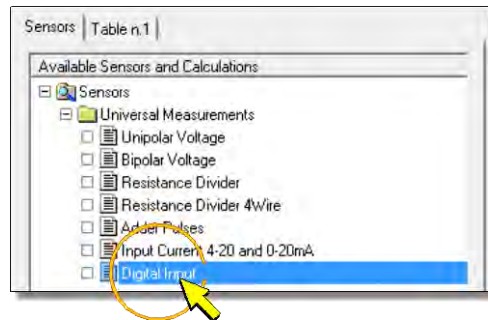

By pressing the *Add Measure* button to add the measurement, the configuration window shown below appears. In the figure there is, for reference, also the detail of the terminal board related to the connection scheme that appears in the window (see the paragraph 5.4 on page 26 for the details of the connections).

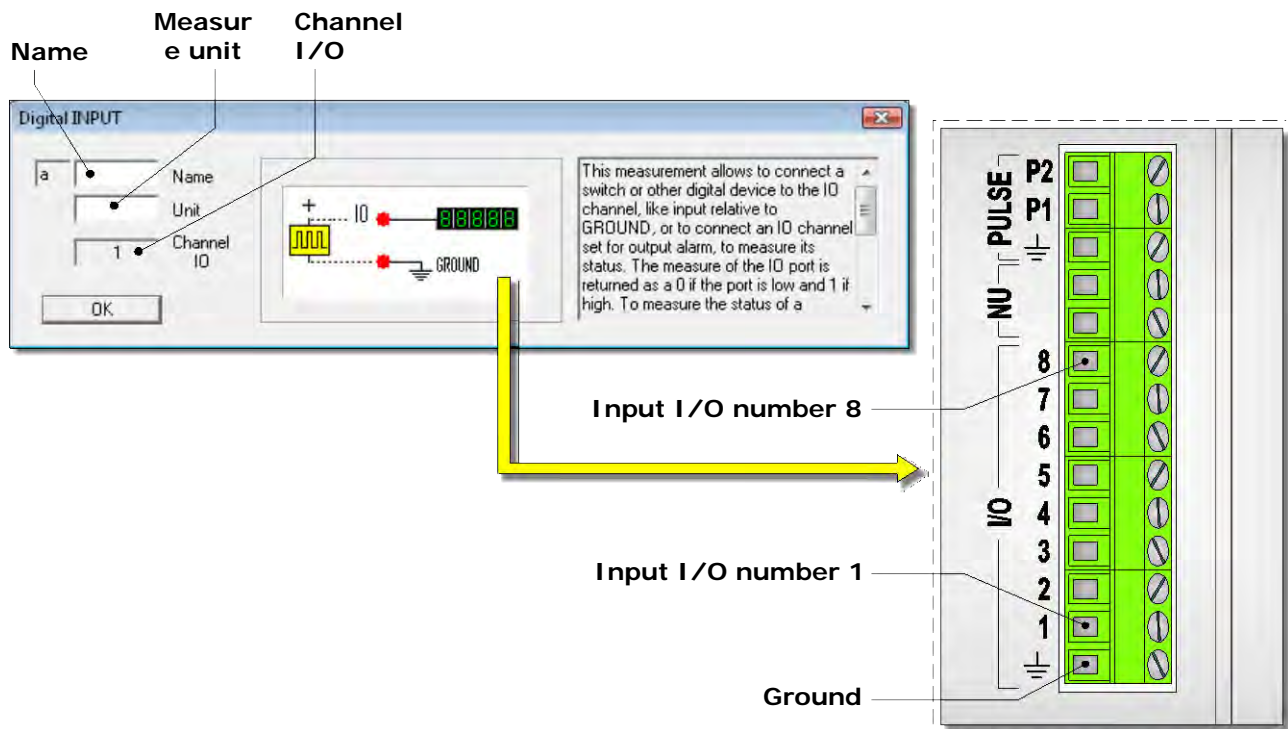

In the configuration window, you must fill in all fields with white background. The fields in gray are not modifiable. The following describes the fields in the window.

- **NAME**

Identification name of the sensor. You can assign as the name, for example, the model of the sensor, or the type of measured quantity. The name must start with a letter and can be up to 12 alphanumeric characters.

The name uniquely identifies the quantity that you are entering, you can not assign the same name to several measures.

- **UNIT (UNIT OF MEASUREMENT)**

Unit of measurement of the quantity detected by the sensor. It must begin with a letter and can be a maximum of 12 alphanumeric characters.

- CHANNEL I/O

Indicates the number of digital input to which the sensor must be connected. The software automatically assigns the first free input. The number is not editable by the user. The digital inputs arrangement is shown at point **6** of the terminal board figure on page 9.

9.2.8 MODBUS RTU CONFIGURATION

In the *Universal Measurements* category, select the *Modbus RTU* item to configure the RS485 serial input for the connection of a sensor with RS485 output and MODBUS-RTU protocol.

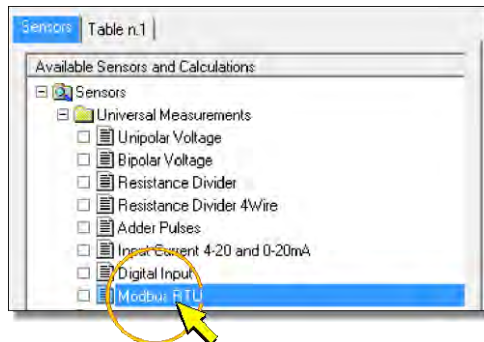

By pressing the *Add Measure* button to add the measure, the configuration window shown below appears. In the figure there is, for reference, also the detail of the terminal board related to the connection scheme that appears in the window (see the paragraph 5.6 on page 29 for the details of the connections).

Number of meas.	Baud rate	Tx/Rx mode	Name	Measure	Wiring diagram
1	19200	UART_8E1			

Gain	Start register	Function n	RS485 address	Data format
04Read Input	1	1	1	Integer 2B

The terminal board diagram shows a vertical strip of terminals. On the left, there are labels: SW IN, ALARM, and COM 485. The COM 485 section has two terminals labeled -D and +D. To the right of these are two terminals labeled 1 and 2. Further right are two terminals labeled 1 and 2. A dashed line indicates an 'Insulated ground' connection to the right side of the board.

In the configuration window, you must fill in all fields with white background. The fields in gray are not modifiable. The following describes the fields in the window.

- QUANTITIES (NUMBER OF MEASURED QUANTITIES)

Select the number of physical quantities that you want to acquire from the sensor. The value can be set from 1 to 10, the value proposed by default is 5.

- NAME

Enter an identifying name for each of the quantities to be acquired. You can assign as the name, for example, the type of measured quantity. The name must start with a letter and can be up to 12 alphanumeric characters. The name uniquely identifies the quantity that you are entering, you can not assign the same name to several measures.

- UNIT (UNIT OF MEASUREMENT)

Unit of measurement of the quantity detected by the sensor. It should begin with a letter and can be maximum 12 characters long. The unit of measurement should be in agreement with the value of the *Gain* parameter. If you do not want to display and store the quantity, enter ---- (dashes) in the *Unit* field.

- BAUD RATE

Select the communication speed of the sensor.

- MODE (COMMUNICATION PARAMETERS)

Select the communication parameters. The following options can be selected:

- UART_8N1: no parity, 1 stop bit
- UART_8E1: even parity, 1 stop bit
- UART_8O1: odd parity, 1 stop bit
- UART_8N2: no parity, 2 stop bits
- UART_8E2: even parity, 2 stop bits
- UART_8O2: odd parity, 2 stop bits

- FORMAT (FORMAT OF DATA)

Select the format of the data transmitted by the sensor. The following options can be selected:

- Integer 2B: 2 Bytes
- Long 4B: 4 Bytes
- Floating Point 4B: 4 Bytes

- ADDRESS

Sensor RS485 address.

- FUNCTION CODE

Select the function code of the Modbus command. The following options can be selected:

- 03 Read Holding Registers
- 04 Read Input Registers

- START REGISTER

Enter the address (not the number) of the register containing the first quantity to be read. The number of consecutive registers to be read is determined by the number of measured quantities.

- GAIN

The value recorded in the data logger is the result of a linear transformation applied to the measured value:

$$\text{Value recorded} = \text{Gain} \times \text{Value measured}$$

The *Gain* value is the same for all the quantities measured by the sensor. You should only enter the numeric value, without unit of measurement, in the *Gain* field. The unit of measurement should be entered in the *Unit* field. By setting *Gain* = 1, the recorded value is exactly the measured value.

SENSOR CONFIGURATION

For the proper functioning of the system, the sensor must be pre-configured with the following settings:

1. The order in which the sensor sends the measures to the output must match the one programmed into the data logger.

2. The units of measurement set in the sensor should match the ones programmed in the datalogger.
3. RS485 with Modbus-RTU protocol communication mode.
4. The RS485 Address must match the one programmed into the data logger.
5. The communication speed (Baud rate) must match the one programmed into the data logger.

9.2.9 SERIAL CHANNELS CONFIGURATION

In the *Universal Measurements* category, select the *Serial Channels* item to configure the RS485 serial input for the connection of a sensor with RS485 output and proprietary protocol.

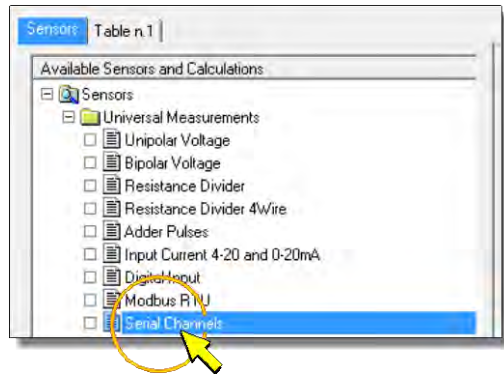

By pressing the *Add Measure* button to add the measure, the configuration window shown below appears. In the figure there is, for reference, also the detail of the terminal board related to the connection scheme that appears in the window (see the paragraph 5.6 on page 29 for the details of the connections).

Number of meas. **Baud rate** **Tx/Rx mode** **Name** **Measure** **Wiring diagram**

Gain **Data request command** **RS485 address** **Data delimiter**

Insulated ground

Input -D **Input +D**

The Serial Channels allows to connect every instrument equipped with a serial output, using the channel COM 485 for half duplex RS485. By the COM 485 are available in the junction box, the two standard inputs D+ (A) and D- (B) plus the ISOLATED ground. The communication it's possible on demand, by a string Command that the

In the configuration window, you must fill in all fields with white background. The fields in gray are not modifiable. The following describes the fields in the window.

- QUANTITIES (NUMBER OF MEASURED QUANTITIES)

Select the number of physical quantities that you want to acquire from the sensor. The value can be set from 1 to 10.

- NAME

Enter an identifying name for each of the quantities to be acquired. You can assign as the name, for example, the type of measured quantity. The name must start with a letter and can be up to 12 alphanumeric characters. The name uniquely identifies the quantity that you are entering, you can not assign the same name to several measures.

- UNIT (UNIT OF MEASUREMENT)

Unit of measurement of the quantity detected by the sensor. It should begin with a letter and can be maximum 12 characters long. The unit of measurement should be in agreement with the value of the *Gain* parameter. If you do not want to display and store the quantity, enter ---- (dashes) in the *Unit* field.

- BAUD RATE

Select the communication speed of the sensor.

- MODE (COMMUNICATION PARAMETERS)

Select the communication parameters. The following options can be selected:

- UART_8N1: no parity, 1 stop bit
- UART_8E1: even parity, 1 stop bit
- UART_8O1: odd parity, 1 stop bit
- UART_8N2: no parity, 2 stop bits
- UART_8E2: even parity, 2 stop bits
- UART_8O2: odd parity, 2 stop bits

- FORMAT (DATA DELIMITER)

Enter the character delimiting the data transmitted by the sensor.

- ADDRESS

Sensor RS485 address.

- COMMAND (COMMAND FOR REQUESTING DATA)

Enter the command string for requesting the values measured by the sensor (Enter= \wedge r , New line= \wedge n).

- GAIN

The value recorded in the data logger is the result of a linear transformation applied to the measured value:

$$\text{Value recorded} = \text{Gain} \times \text{Value measured}$$

The *Gain* value is the same for all the quantities measured by the sensor. You should only enter the numeric value, without unit of measurement, in the *Gain* field. The unit of measurement should be entered in the *Unit* field. By setting *Gain* = 1, the recorded value is exactly the measured value.

SENSOR CONFIGURATION

For the proper functioning of the system, the sensor must be pre-configured with the following settings:

1. The order in which the sensor sends the measures to the output must match the one programmed into the data logger.
2. The units of measurement set in the sensor should match the ones programmed in the datalogger.
3. The RS485 Address must match the one programmed into the data logger.
4. The communication speed (Baud rate) must match the one programmed into the data logger.

9.2.10 GPS CONFIGURATION

In the *Universal Measurements* category, select the *GPS* item to detect the GPS data via the HD5320 external module connected to the COM AUX port. The GPS data appear in the header of the files with the measurements to identify the installation site.

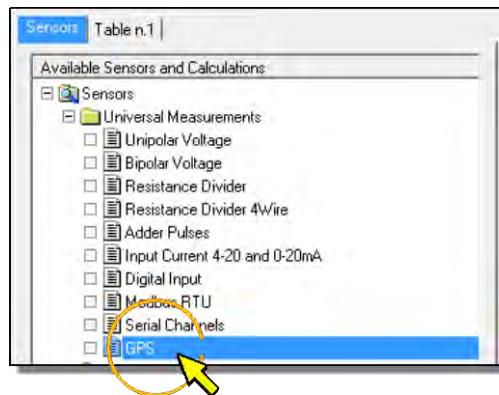

By pressing the *Add Measure* button to add the detection, the configuration window shown below appears.

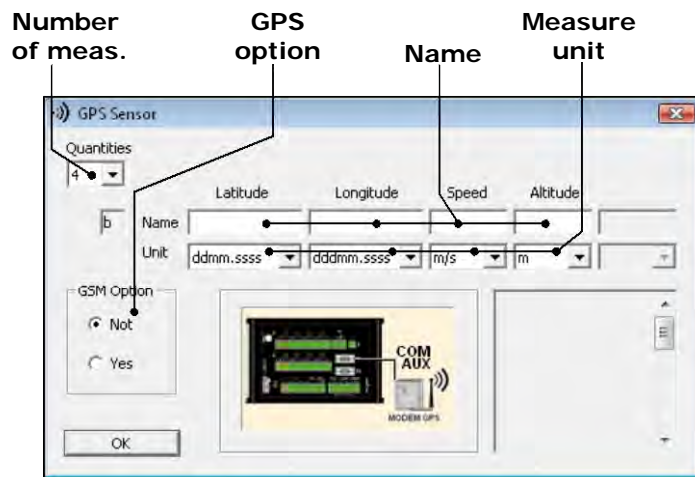

In the configuration window, you must fill in all fields with white background. The fields in gray are not modifiable. The following describes the fields in the window.

- **QUANTITIES (NUMBER OF MEASURED QUANTITIES)**

Select the number of physical quantities that you want to acquire from the sensor. The value can be set from 1 to 4.

- **NAME**

Enter an identifying name for each of the quantities to be acquired. You can assign as the name, for example, the type of measured quantity. The name must start with a letter and can be up to 12 alphanumeric characters. The name uniquely identifies the quantity that you are entering, you can not assign the same name to several measures.

- **UNIT (UNIT OF MEASUREMENT)**

Unit of measurement of the quantity.

- **GSM OPTION**

Select *Yes* if the GSM/UMTS features of the HD5320 module are used, otherwise select *No*.

9.2.11 U.S. ANEMOMETERS HD2003 AND U.S. ANEMOMETERS HD52.3D CONFIGURATIONS

In the *Environmental Analysis* category, select the *U.S. Anemometers HD2003* or *U.S. Anemometers HD52.3D* item to configure the RS485 serial input for the connection of an ultrasonic anemometer Delta OHM series HD2003 or HD52.3D, respectively.

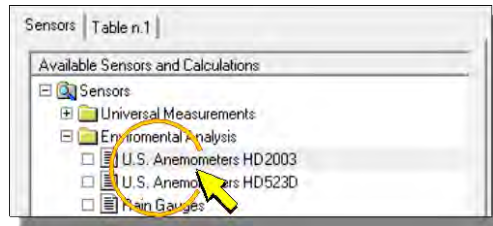

By pressing the *Add Measure* button to add the measure, the configuration window shown below appears. In the figure there is, for reference, also the detail of the terminal board related to the connection scheme that appears in the window (see the paragraph 5.6 on page 29 for the details of the connections).

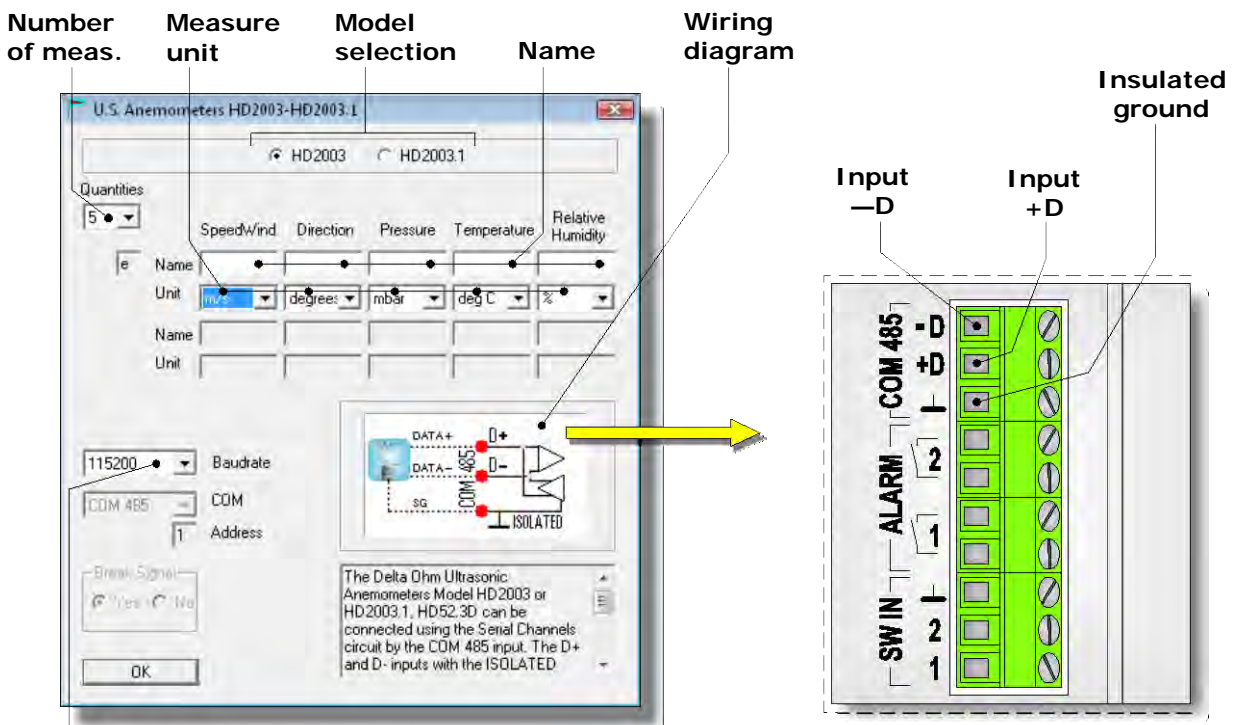

Baud rate

At the top of the configuration window, select the model of anemometer to be connected.

In the configuration window, you must fill in all fields with white background. The fields in gray are not modifiable. The following describes the fields in the window.

- **QUANTITIES (NUMBER OF MEASURED QUANTITIES)**

Select the number of physical quantities that you want to acquire from the anemometer. The value can be set from 1 to 10, the value proposed by default is 5.

For models HD2003 and HD52.3D147, the order of the first 5 quantities is fixed:

- Wind Speed
- Wind Direction
- Barometric Pressure
- Temperature

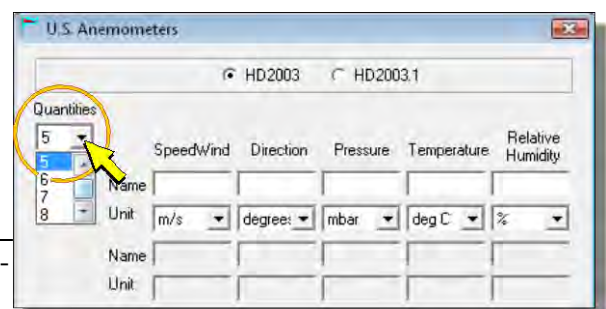

- o Relative Humidity

For HD2003.1 and HD52.3D models, the first 2 quantities are fixed: wind speed and direction.

- **NAME**

Enter an identifying name for each of the quantities to be acquired. You can assign as the name, for example, the type of measured quantity. The name must start with a letter and can be up to 12 alphanumeric characters.

The name uniquely identifies the quantity that you are entering, you can not assign the same name to several measures.

- **UNIT (UNIT OF MEASUREMENT)**

Select a unit of measurement for the speed of wind among those proposed. The unit selected must be identical to that set in the anemometer.

The unit of measurement of the other quantities is fixed.

If there are optional variables, in addition to the quantities set by the program, type in the relevant unit of measurement in the *Unit* field (at max. 12 alphanumeric characters starting with a letter).

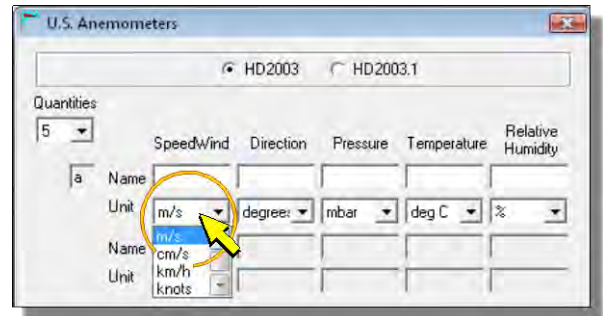

- **BAUD RATE**

Select the communication speed of the anemometer.

- **ADDRESS**

Anemometer RS485 address. The software automatically assigns the address. The number is not editable by the user.

ANEMOMETER CONFIGURATION

For the proper functioning of the system, the anemometer must be pre-configured with the following settings:

1. The order in which the anemometer sends the measures to the output must match the one programmed into the data logger.
2. The unit of measurement of air speed set in the anemometer must match the one programmed in the data logger.
3. Averaging period of the measures equal to 1 second.
4. RS485 communication mode with proprietary protocol.
5. The RS485 Address must match the one programmed into the data logger.
6. The communication speed (Baud rate) must match the one programmed into the data logger.

9.2.12 RAIN GAUGE CONFIGURATION

To configure an input for connecting a rain gauge with a voltage-free ON/OFF contact output, select *Rain Gauges* inside the category *Environmental Analysis*.

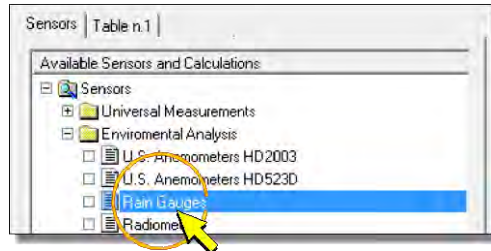

Press the *Add Measure* button to add the measurement and this opens the configuration window shown below. In the figure there is, for reference, also the detail of the terminal board related to the connection scheme that appears in the window (please see the paragraph 5.5.2 on page 27 for the details of the connections).

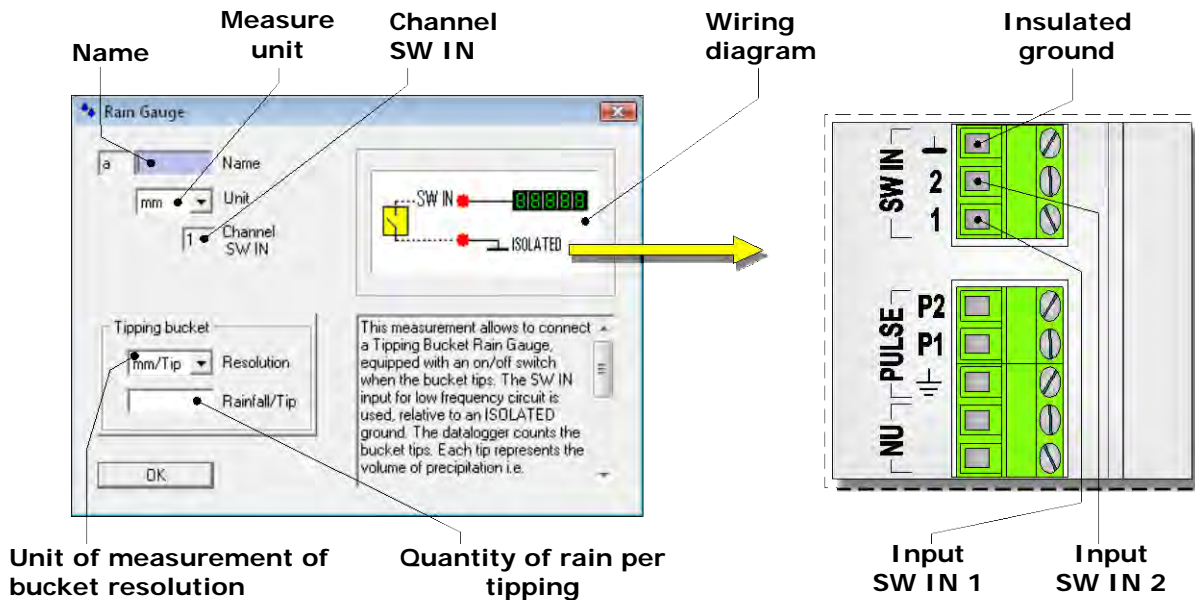

In the configuration window, you must fill in all fields with white background. The fields in gray are not modifiable. The following describes the fields in the window.

- **NAME**

Identification name of the sensor. You can assign as the name, for example, the model of the sensor, or the type of measured quantity. The name must start with a letter and can be up to 12 alphanumeric characters.

The name uniquely identifies the quantity that you are entering, you can not assign the same name to several measures.

- **UNIT (UNIT OF MEASUREMENT)**

Select the desired unit of measurement for the amount of rain between *mm* and *inch*.

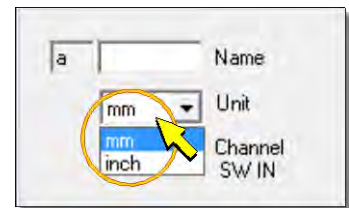

- **CHANNEL SW IN**

Indicates the number of the SW IN input to which the sensor must be connected. The software automatically assigns the first free input. The number is not editable by the user. The location of the SW IN inputs is indicated at point 9 of the terminal board figure on page 9.

- **RESOLUTION** (UNIT OF MEASUREMENT OF RESOLUTION)

In the field should be selected the unit of measurement of the resolution printed in the rain gauge data sheet. The selectable settings are *mm/Tip* and *inch/Tip*.

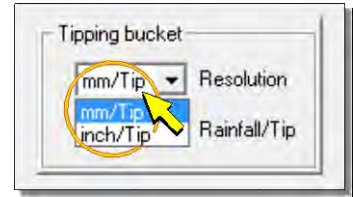

- **RAINFALL/TIP** (QUANTITY OF RAIN PER TIPPING)

Enter the resolution value reported in the technical data sheet of the rain gauge. The value is the amount of rain that causes the switching of the tipping bucket. Must be inserted only the numerical value without unit.

9.2.13 RADIOMETRY CONFIGURATION

To configure an input for connecting a solar radiation sensor with voltage output, select *Radiometry* item inside the *Environmental Analysis* category.

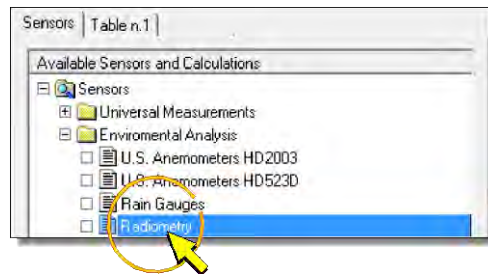

By pressing the *Add Measure* button to add the measurement, the window for selecting the connection type appears.

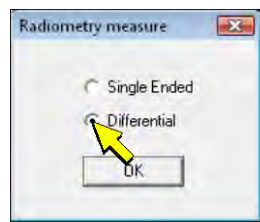

Select *Single Ended* option if you are planning a single-ended connection (measuring signal connected between a single-ended input and the analog ground) or *Differential* option if you plan to connect the sensor in differential mode (measuring signal connected between two analog inputs). The differential mode is recommended for sensors with mV output, so as to reduce the influence of noise on the measurement signal. For sensors with normalized voltage output, the single-ended connection is sufficient.

Press *OK* to confirm, so the configuration window shown below appears. In the figure there is, for reference, also the detail of the terminal board related to the connection scheme that appears in the window (see the paragraph 5.3.1 on page 18 for the details of the connections).

WINDOW WITH SINGLE ENDED OPTION

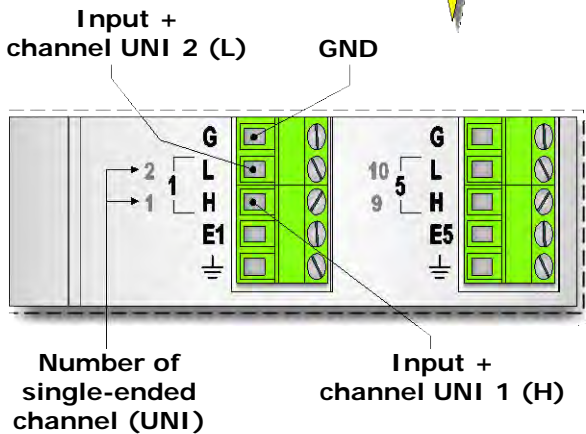
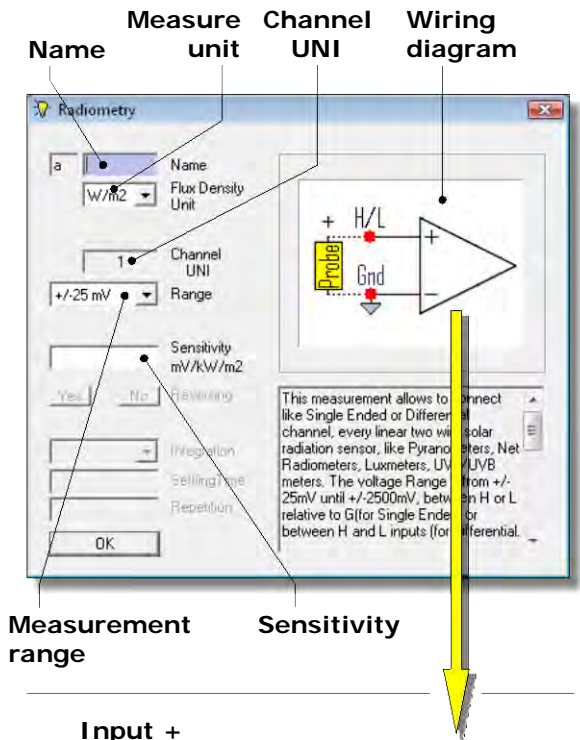

WINDOW WITH DIFFERENTIAL OPTION

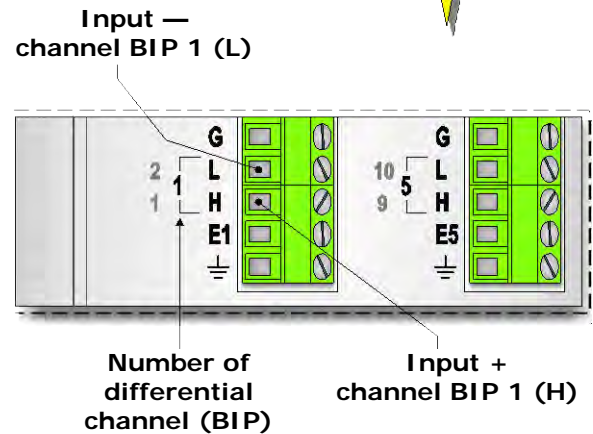
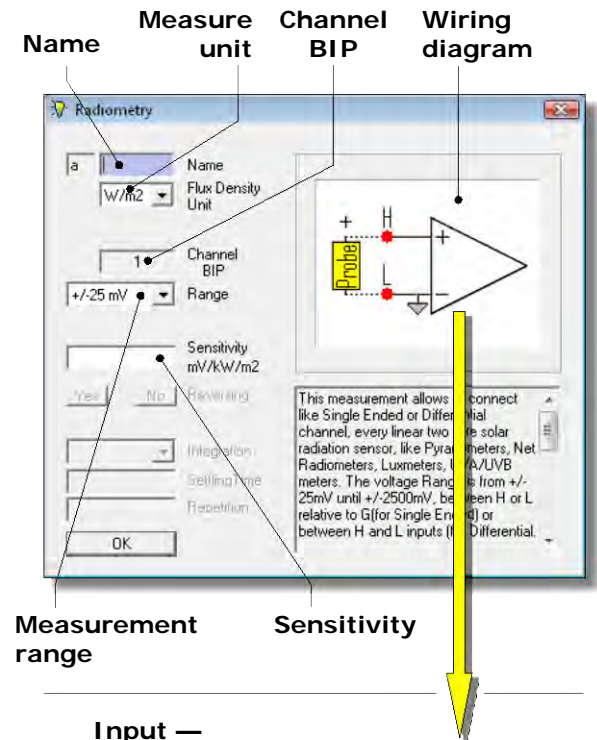

In the configuration window, you must fill in all fields with white background. The fields in gray are not modifiable. The following describes the fields in the window.

- **NAME**

Identification name of the sensor. You can assign as the name, for example, the model of the sensor, or the type of magnitude being measured. The name must start with a letter and can be up to 12 alphanumeric characters.

The name uniquely identifies the measure that you are entering, you can not assign the same name to several measures.

- **FLUX DENSITY UNIT (UNIT OF MEASUREMENT)**

Select the unit of measurement of the quantity measured by the sensor. There are two possible options: *kLux* and *W/m²* (*W/m²*).

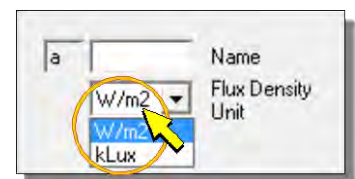

- **CHANNEL UNI OR CHANNEL BIP**

Indicates the number of analog input to which the sensor must be connected. The software automatically assigns the first free input. The number is not editable by the user. The location of the analog inputs is shown at point **4** of the terminal board figure on page 9.

- RANGE

It is the measuring range of the data logger input. Click on the *Range* field and then select a measuring range suitable for the sensor that is being inserted, so that the voltage sensor output is within the measurement range selected. There are four selectable ranges:

- ±25 mV
- ±100 mV
- ±1000 mV
- ±2500 mV

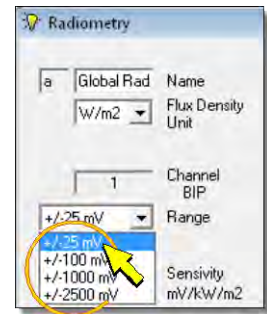

To get the best resolution of measurement it is convenient to choose the first measurement range higher than the output of the sensor.

If the sensor output is too high to fall within the ranges available, it is necessary to reduce the signal by inserting a resistive divider between the output of the sensor and the data logger input (see paragraph 5.3.1 on page 18 for the connection).

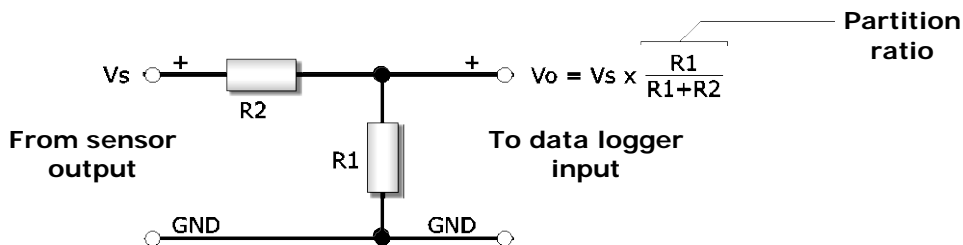

The sum of the values of R1 and R2 must be greater than the minimum load resistance of the sensor.

Only as an example, the table below shows the range selectable and the need of divider for different voltage outputs that are typically available in Delta ohm sensors with normalized voltage output.

Sensor Output	Selectable Range (*)	Resistive Divider
0 ÷ 1 V	±1000 mV or ±2500 mV	No
0 ÷ 5 V	±1000 mV or ±2500 mV	Yes, partition ratio 1/5
0 ÷ 10 V	±1000 mV or ±2500 mV	Yes, partition ratio 1/10
1 ÷ 5 V	±1000 mV or ±2500 mV	Yes, partition ratio 1/5
2 ÷ 10 V	±1000 mV or ±2500 mV	Yes, partition ratio 1/10

(*) *Note:* Some sensors can provide an output voltage that exceeds the nominal value of the scale, if the measured quantity exceeds the range measured. If you want that error condition is also recorded by the logger, you must set a value in the *Range* field higher than the nominal range of the sensor. For example, for a sensor with a nominal 0-1V output we have to select the range ±2500 mV, not the ±1000 mV range.

For sensors with not normalized mV output, the maximum output voltage is obtained by multiplying the sensitivity of the sensor by the full scale value of the measured quantity.

- SENSITIVITY

In this field, the value of the sensitivity of the sensor must be inserted. **The entered value must be expressed in mV/(kW m⁻²) or mV/klux** depending on the type of quantity measured by the sensor. If the sensitivity is known in a different unit, you must convert in the units above. Must be inserted only the numerical value without unit.

For sensors with direct mV output, the sensitivity is usually stated by the manufacturer and is also indicated on the housing of the sensor.

For sensors with normalized voltage output, the sensitivity should be calculated by dividing the output voltage range by the measurement range of the physical quantity.

Example 1

Suppose you need to set up a pyranometer with normalized 0 to 10V voltage output and measurement range 0 to 2000 W/m². Between the transmitter and data logger it is inserted a resistive divider with a partition ratio of 1 / 10.

The configuration values of the logger input are:

Flux Density Unit = W/m²

Range = ±1000mV.

Sensitivity = 10 / 2000 = 0.005 V/(W m⁻²) = 5000 mV/(kW m⁻²). The value to be entered is 5000.

Example 2

Suppose you need to configure a pyranometer with mV output and measurement range 0 to 2000 W/m². The sensitivity is declared 10 μV/(Wm⁻²). The transmitter output is connected directly to the data logger input (resistive dividers are not present).

The maximum voltage that can be generated from the sensor is equal to the sensitivity multiplied by the full scale of the measured quantity: 10 x 2000 = 20.000 μV = 20 mV.

The configuration values of the of the logger input are:

Flux Density Unit = W/m²

Range = ±25 mV.

Sensitivity = 10 μV/(Wm⁻²) = 10 mV/(kW m⁻²). The value to be entered is 10.

9.2.14 Pt100-Pt1000 THERMOMETERS CONFIGURATION

To configure an input for connecting a 4-wire Pt100 or Pt1000 temperature probe with coefficient $\alpha = 0.00385$ (IEC 751), select the *Pt100-Pt1000 Thermometers* item in the *Industry* category.

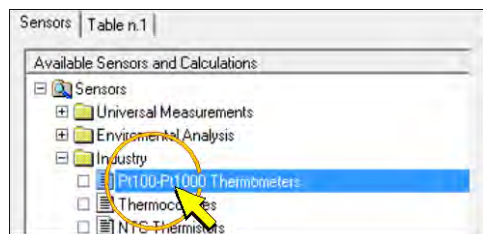

By pressing the *Add Measure* button to add the measurement, the configuration window shown below appears. In the figure there is, for reference, also the detail of the terminal board related to the connection scheme that appears in the window (see the paragraph 5.3.5 on page 24 for the details of the connections).

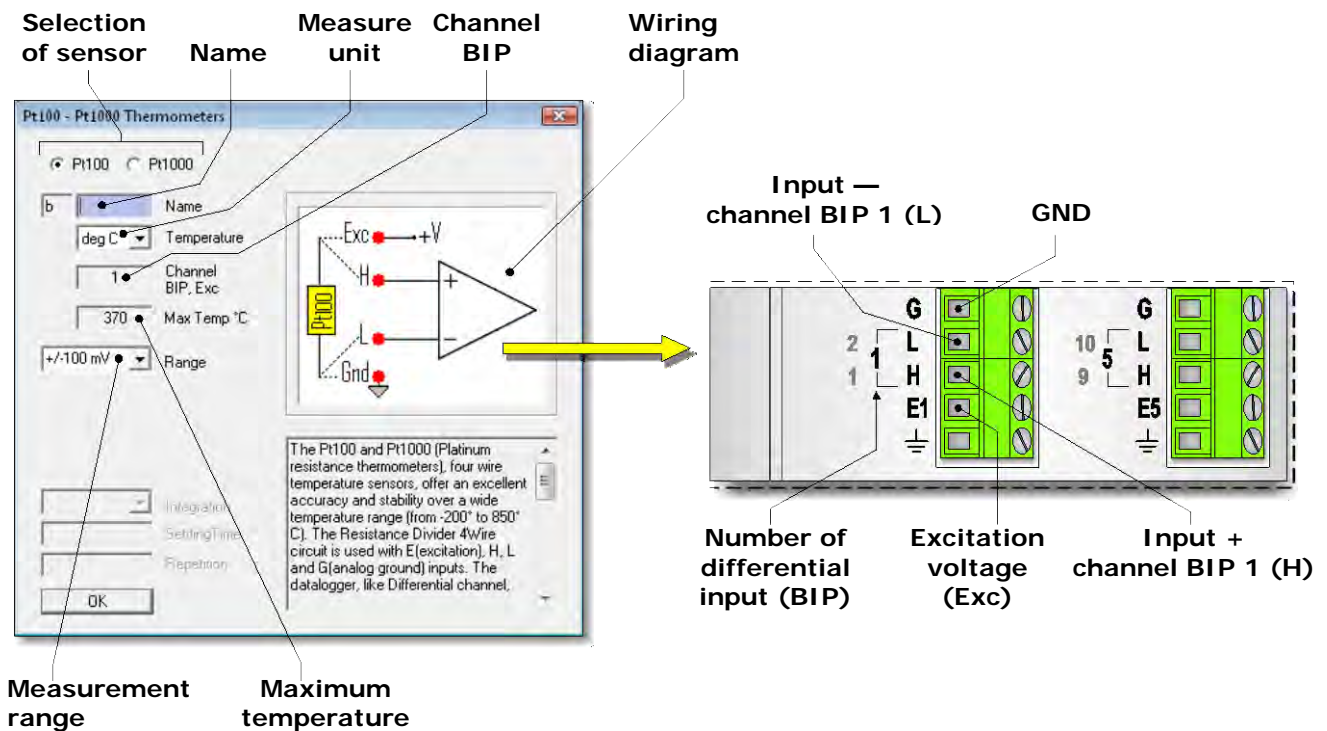

In the top left of the configuration window, select *Pt100* or *Pt1000* according to the type of sensor used.

In the configuration window, you must fill in all fields with white background. The fields in gray are not modifiable. The following describes the fields in the window.

- NAME

Identification name of the sensor. You can assign as the name, for example, the model of the sensor, or the type of measured quantity. The name must start with a letter and can be up to 12 alphanumeric characters.

The name uniquely identifies the measure that you are entering, you can not assign the same name to several measures.

- TEMPERATURE (TEMPERATURE UNIT OF MEASUREMENT)

Select the desired unit of measurement among: *deg C* (Celsius degrees), *deg F* (Fahrenheit degrees) and *deg K* (Kelvin degrees).

The data logger computes, using the coefficient $\alpha = 0.00385$, the value of temperature corresponding to the measured resistance value, and directly records the temperature value in the chosen unit of measurement.

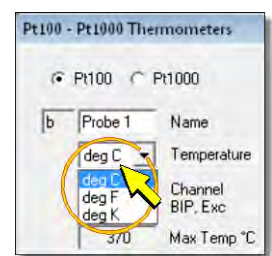

- CHANNEL BIP,EXC

It Indicates the number of analog input to which the sensor must be connected. The software automatically assigns the first free input. The number is not editable by the user. The location of the analog inputs is shown at point **4** of the terminal board figure on page 9.

- RANGE

Select the desired measuring range. The options presented depend on the type of sensor.

For sensor type **Pt100** select:

- ± 100 mV for temperature measurements up to 370 °C
- ± 1000 mV for temperature measurements up to 850 °C

For sensors type **Pt1000** select:

- o ± 1000 mV for temperature measurements up to 370 °C
- o ± 2500 mV for temperature measurements up to 850 °C

If you plan to measure temperatures not higher than 370 °C it is convenient to choose the lower range because it allows better measurement resolution.

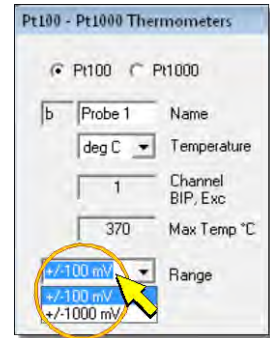

- MAX TEMP °C (MAXIMUM TEMPERATURE IN °C)

It is the maximum temperature that can be measured with the current setting in the *Range* field. The value cannot be changed directly but it is calculated automatically according to the option selected in the *Range* field.

9.2.15 THERMOCOUPLES CONFIGURATION

To configure an input to connect a thermocouple temperature probe, select the *Thermocouples* item in the *Industry* category.

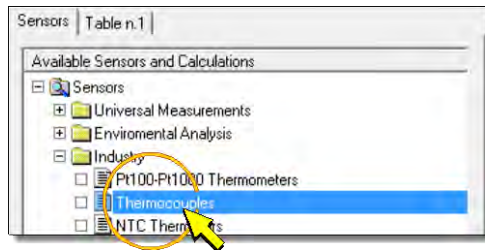

By pressing the *Add Measure* button to add the measurement, the configuration window shown below will appear. In the figure is shown, as a reference, also the detail of the terminal board concerning the wiring diagram appearing on the window (see the paragraph 5.3.6 on page 25 for the details of the connections).

Type selection

Name

Measure unit

Channel BIP

Wiring diagram

Position of cold junction

Measurement range

Input — channel BIP 1 (L)

Number of differential input (BIP)

Input + channel BIP 1 (H)

In the configuration window, you must fill in all fields with white background. The fields in gray are not modifiable. The following describes the fields in the window.

- **TYPE (TYPE OF THERMOCOUPLE)**

In the *Type* field select the type of thermocouple to be connected to the data logger. You can connect thermocouples type K, J, T, N, R, S, B, E.

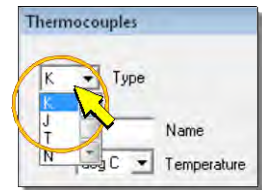

- **NAME**

Identification name of the sensor. You can assign as the name, for example, the model of the sensor, or the type of quantity measured. The name must start with a letter and can be up to 12 alphanumeric characters.

The name uniquely identifies the measure that you are entering, you can not assign the same name to several measures.

- **TEMPERATURE (UNIT OF TEMPERATURE MEASUREMENT)**

Select the desired unit of measurement among: *deg C* (Celsius degrees), *deg F* (Fahrenheit degrees) and *deg K* (Kelvin degrees).

The data logger calculates the temperature corresponding to the value of the input voltage in mV, and directly stores the value of temperature in the selected unit of measurement.

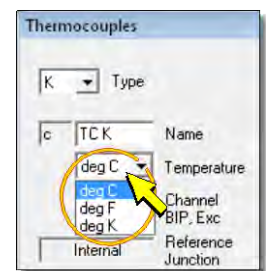

- **CHANNEL BIP**

Indicates the number of analog input to which the sensor must be connected. The software automatically assigns the first free input. The number is not editable by the user. The analog inputs arrangement is shown at point **4** of the terminal board figure on page 9.

- **REFERENCE JUNCTION (COLD JUNCTION)**

The field is fixed to the value *Internal*. The cold junction is located at the connection point of the thermocouple to the data logger and the junction temperature is measured by a temperature sensor inside the logger. Do not connect external temperature sensors for cold junction compensation

- **TEMP RANGE °C (TEMPERATURE RANGE IN °C)**

It indicates the temperature measurement range with thermocouple type selected. The value that appears is set automatically depending on the option selected in the *Type* field. The correspondence between the type of thermocouple and the measured field is shown in the table below:

Type of thermocouple	Measurement range
K	-200...+550 °C
J	-210...+420 °C
T	-200...+400 °C
N	-200...+660 °C
R	-50...+1760 °C
S	-50...+1760 °C
B	+250...+1820 °C
E	-200...+330 °C

9.2.16 NTC THERMISTOR CONFIGURATION

To configure an input for connecting an NTC thermistor temperature probe, select the *NTC Thermistors* item in the *Industry* category.

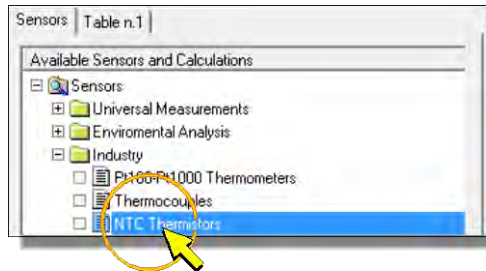

Press the *Add Measure* button to add the measurement and this opens the configuration shown below. In the figure is shown, as a reference, also the detail of the terminal board concerning the wiring diagram appearing on the window (see the paragraphs 5.3.3 on page 23 for the details of the connections).

Name	Measure unit	Channel UNI	Terminal (E)	Excitation voltage	Wiring diagram
NTC Thermistors	deg C	1	H/L	2500 mV	

NTC Thermistors Configuration Window:

- Name:** b
- Temperature:** deg C
- Channel UNI:** 1
- Channel Exc:** 1
- VExc:** 2500 mV
- BETA:** 3579.0
- NTC / Rf Range:** 0.001 to 100.00

Measurable values: BETA

Terminal Board Wiring Diagram:

- Input + channel UNI 2 (L):** Terminal 2 (L)
- GND:** Terminal 10 (G)
- Input + channel UNI 1 (H):** Terminal 1 (H)
- Excitation voltage (Exc):** Terminal 1 (H)
- Number of single-ended channel (UNI):** Terminal 5 (L)

In the configuration window, you must fill in all fields with white background. The fields in gray are not modifiable. The following describes the fields in the window.

- **NAME**

Identification name of the sensor. You can assign as the name, for example, the model of the sensor, or the type of measured quantity. The name must start with a letter and can be up to 12 alphanumeric characters.

The name uniquely identifies the measure that you are entering, you can not assign the same name to several measures.

- **TEMPERATURE (UNIT OF TEMPERATURE MEASUREMENT)**

Select the desired unit of measurement among: *deg C* (Celsius degrees), *deg F* (Fahrenheit degrees) and *deg K* (Kelvin degrees).

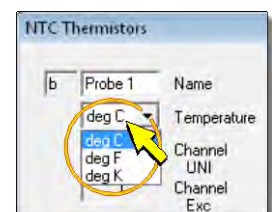

The data logger calculates the temperature corresponding to the resistance value measured as a function of the value inserted in the *BETA* field, and directly store the value of temperature in the chosen unit of measurement.

- CHANNEL UNI

It Indicates the number of analog input to which the sensor must be connected. The software automatically assigns the first free input. The number is not editable by the user. The analog inputs arrangement is shown at point **4** of the terminal board figure on page 9.

The programmable inputs for this type of measurement are only the single-ended inputs 1, 2, 3 and 4.

- CHANNEL EXC (EXCITATION TERMINAL)

Indicates the number of the terminal **E** from where the excitation voltage must be taken, which is the terminal where you must connect one end of the reference resistor **Rf**. The number is assigned automatically and is not editable by the user.

- VEXC (EXCITATION VOLTAGE)

It is the excitation voltage applied to terminal **E**. The value is fixed at 2500 mV.

- BETA (CONSTANT OF THE MATERIAL)

Write in this field the value of the coefficient BETA (β) reported in the sensor specifications.

- NTC/Rf RANGE

It is the measuring range of sensor resistance value compared to the reference resistance Rf. The field can not be set. The minimum and maximum values measurable are respectively:

$$NTC_{\min} = Rf / 1000$$

$$NTC_{\max} = 100 \times Rf$$

The value of Rf to be connected is the thermistor resistance value at 25 °C.

The reference resistor Rf must be a precision resistor and sufficiently stable over time and exposure to environmental conditions, since the drift of the Rf values results in a measurement change not due to a real variation in temperature.

9.2.17 ERROR MESSAGES WHILE SETTING THE PARAMETERS

If the parameters are not correctly set in the configuration window, you can get the following error messages.

- *The name and Unit fields are required!*

Cause: The name or the unit of measurement field is not filled in.

- *There is just an equivalent Name !*

Cause: it has already been previously entered a sensor with the same name. You must change the name.

Note: the software does not distinguish between uppercase and lowercase letters (for example the name TC_K is assumed to be the same as tc_K).

- *Gain must be not zero !*

Cause: *Gain* field was not filled in or has been put to zero.

- *The Sensitivity must be positive !*

Cause: the *Sensitivity* field of the *Radiometry* configuration has not been filled in or has been set to zero or negative value.

- *Rainfall/Tip must be positive !*

Cause: the *Rainfall/Tip* field of the *Rain Gauge* configuration has not been filled in or has been set to zero or negative value.

- *BETA must be positive !*

Cause: the *BETA* field of the *NTC Thermistors* configuration has not been filled in or has been set to zero or negative value.

9.3 DEFINING THE CALCULATED QUANTITIES

The values measured by the sensors can be used to calculate and store derived quantities. The following default derived quantities are available: **Dew Point**, **Heat Index**, **Wind Chill**, **Evapotranspiration** (standard evapotranspiration ET_0), **Saturation Vapor Pressure**. The **HD32MTLogger** software allows to create derived quantities defined by the user.

To add a derived quantity to the measurement acquisition and recording program, proceed as indicated below:

1. In the program window, ensure the *Sensors* panel is selected on the left.

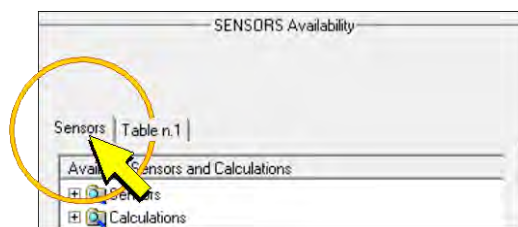

2. Expand the *Calculations* folder and select the type of quantity (e.g. *Dew Point*) and click on the *Add Measure* green arrow button at the center of the window (or double click on the quantity name).

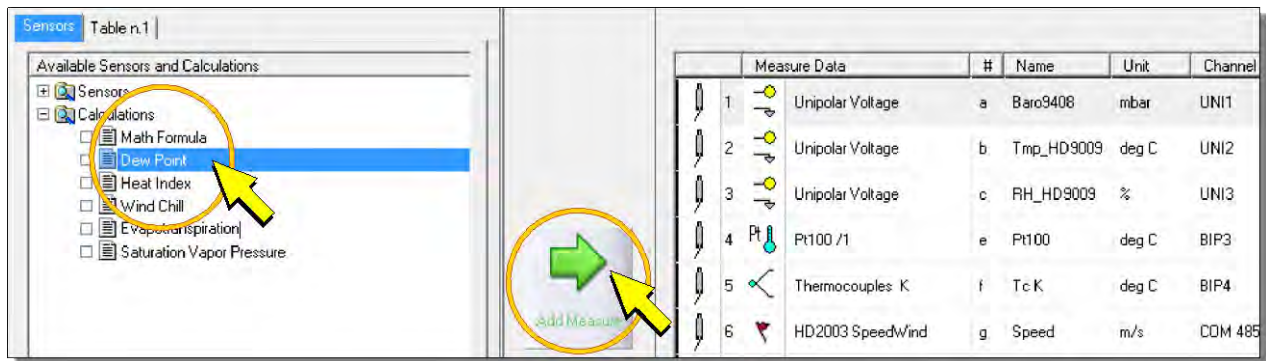

3. The configuration window will open. Here, you can enter all required parameters.

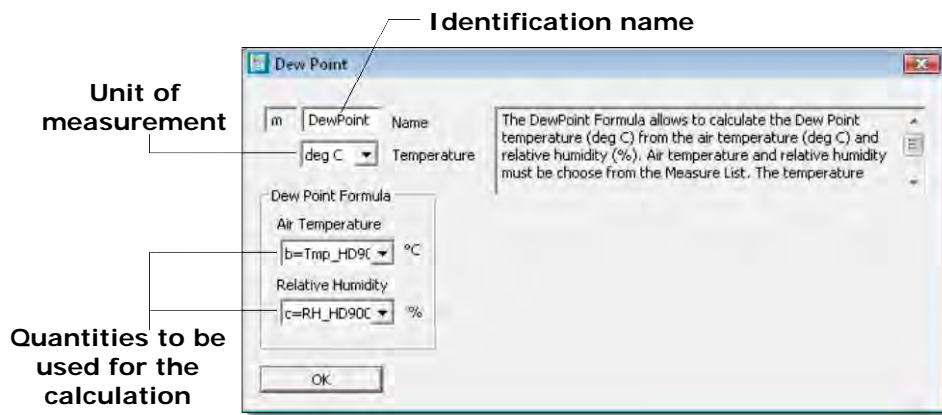

Note: if the evapotranspiration has been selected, the configuration window does not open now, but when the quantity is added to a store table (please see paragraph 9.4 on page 104).

Fill all editable fields (only those with white background):

- o The *Name* field to enter an identification name for the derived quantity. The name should begin with a letter and can be maximum 12 characters long.
- o The field of the unit of measurement of the quantity (the unit is fixed for the default derived quantities).
- o The fields to select the quantities to be used for the calculation. The quantities can be selected from a drop-down list among those already entered in the measurement acquisition and recording program. For the saturation vapor pressure, indicate in the *Reference* field if it should be referenced to water or ice.

Press *OK* to return to the program window.

Note: to cancel the input of the quantity, select the small cross up to the right.

4. Press *OK*, In the right box of the window (*MEASURE List*) you will see the added quantity.



Standard Evapotranspiration ET₀

The standard evapotranspiration ET₀ is calculated according to the **ASCE Penman-Monteith** method.

The window to configure the standard evapotranspiration ET₀ opens when the quantity is added to a store table (please see paragraph 9.4 on page 104).



In the *Quantities* section of the configuration window, select the quantities to be used for the calculation. The quantities are selectable from a drop-down list among those already entered in the acquisition and recording program.

- *Air Temperature*
- *Relative Humidity*
- *Wind Speed*
- *Solar Radiation*

In the *Site* section of the configuration window, enter:

- *Latitude* : latitude of the measurement site expressed in decimal form (North latitude is positive, South latitude is negative, e.g.: 46°24'29" South latitude = -46.448)
- *Longitude* : longitude of the measurement site expressed in decimal form (East longitude is positive, West longitude is negative, e.g.: 11°49'12" East longitude = 11.836)
- *Wind sensor height* : height above ground of the wind speed sensor (from 2 to 10 m)
- *Elevation over sea level* : altitude of the measurement site

In the *Crop* section of the configuration window, select the reference culture (ASCE short, ASCE tall or FAO paper 56).

In the *Period* section of the configuration window, select:

- *Hour* to store the standard evapotranspiration, in mm/hour, once an hour. In addition to the standard evapotranspiration, the temperature, relative humidity, wind speed and solar radiation average values are also stored.
- *Day* to store the standard evapotranspiration, in mm/day, once a day. In addition to the standard evapotranspiration, the temperature and relative humidity maximum and minimum values, and the wind speed and solar radiation average values are also stored.

When the configuration is completed, press *OK* to add the evapotranspiration to the store table.

Calculated quantities defined by the user

To add to the measurement acquisition and recording program a derived quantity defined by the user, select *Math Formula* and click on the *Add Measure* green arrow button at the center of the window (or double click on *Math Formula*).

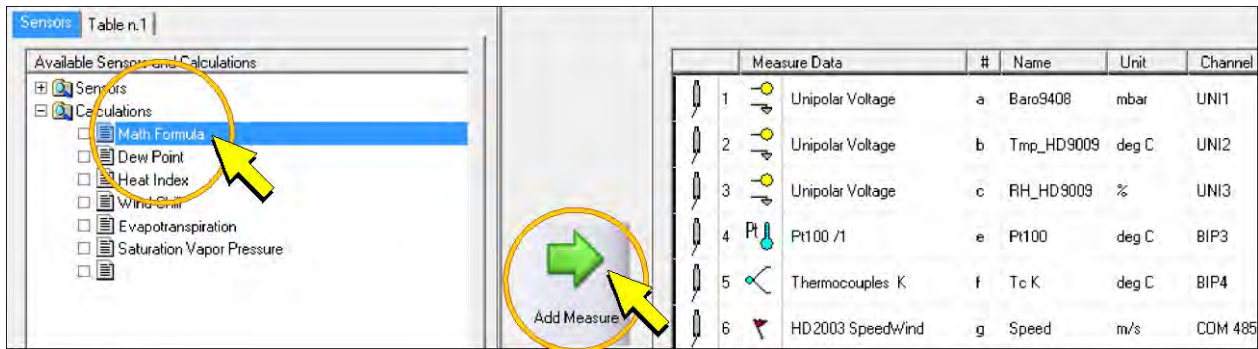

In the configuration window, fill the *Name* and *Unit* fields. The unit should begin with a letter and can be maximum 12 characters long. In the *Math User Formula* field, enter the formula to calculate the quantity, by using as operands the letters that identify the measured quantities listed in the *MEASURE List* section. The section *Operators Functions Controls* lists the operators and the functions available. The formula can be maximum 100 characters long. The parentheses () can be used.

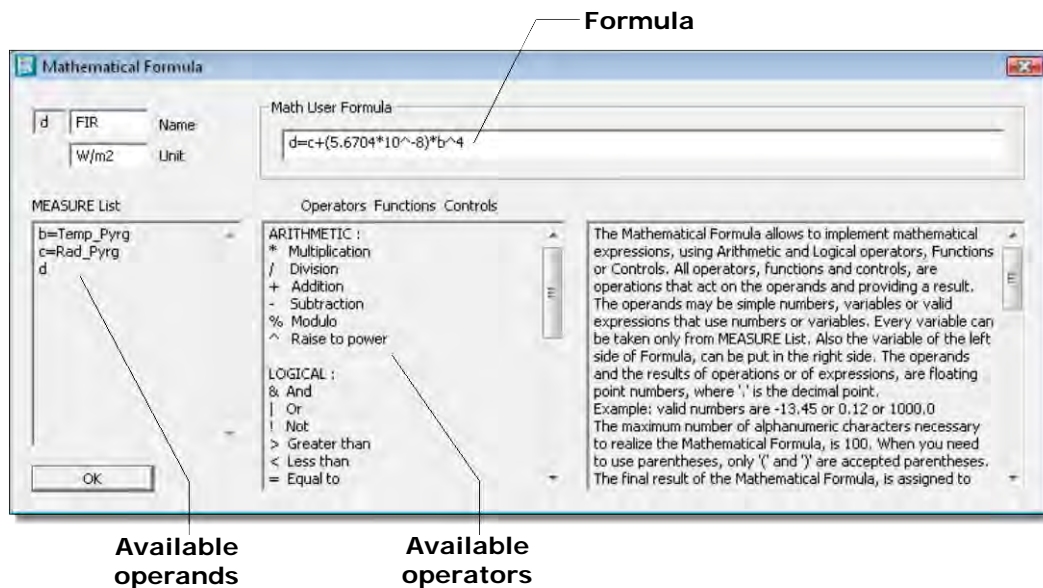

The previous figure shows the calculation of the Far Infrared Radiation (FIR) using the temperature (quantity *b*) and the radiation (quantity *c*) measured by a pyreometer ($FIR = Rad_Pyrg + K \cdot T^4$, with $K=5.6704 \cdot 10^{-8} \text{ Wm}^{-2}\text{K}^{-4}$ Boltzmann constant).

Press *OK*, In the right box of the window (*MEASURE List*) you will see the added quantity.

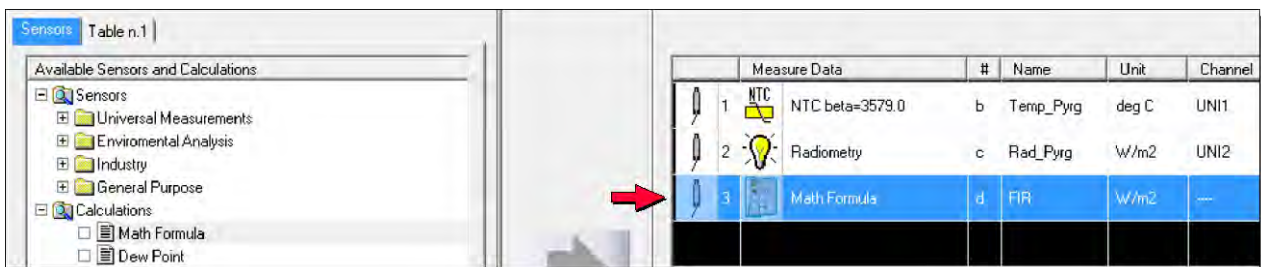

Note: if you do not want to display and store the result of the formula, for example because it is a partial result of a more complex calculation, enter ---- (dashes) in the *Unit* field.

9.4 CREATING THE STORE TABLES

After you define the list of measures (*MEASURE List*) and the acquisition interval (*SCAN Period*), you must determine which measures should be stored in the data logger and when.

It is important to note that in the data logger the process of measures acquisition is distinct from the process of measures recording. The definition of the list of measures and acquisition interval does not involve the automatic storage of acquired data. To store a measurement it is necessary to insert it into a store table.

A program can consist of one or more store tables. The use of multiple tables allows to store the various measures at different intervals.

To define the first store table, proceed as follows:

1. In the left panel of the program window, select the folder *Table n.1*, by clicking on the relevant label.

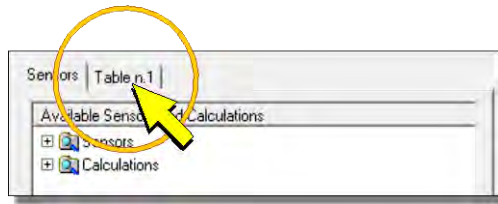

Note: the folder is selectable only if the *MEASURE List* includes at least one sensor.

2. In the left pane appears an empty table. To insert a measure, select it from the list in the right pane of the window (*MEASURE List*) and click on the *Add Store* button with the blue arrow at the centre of the window.

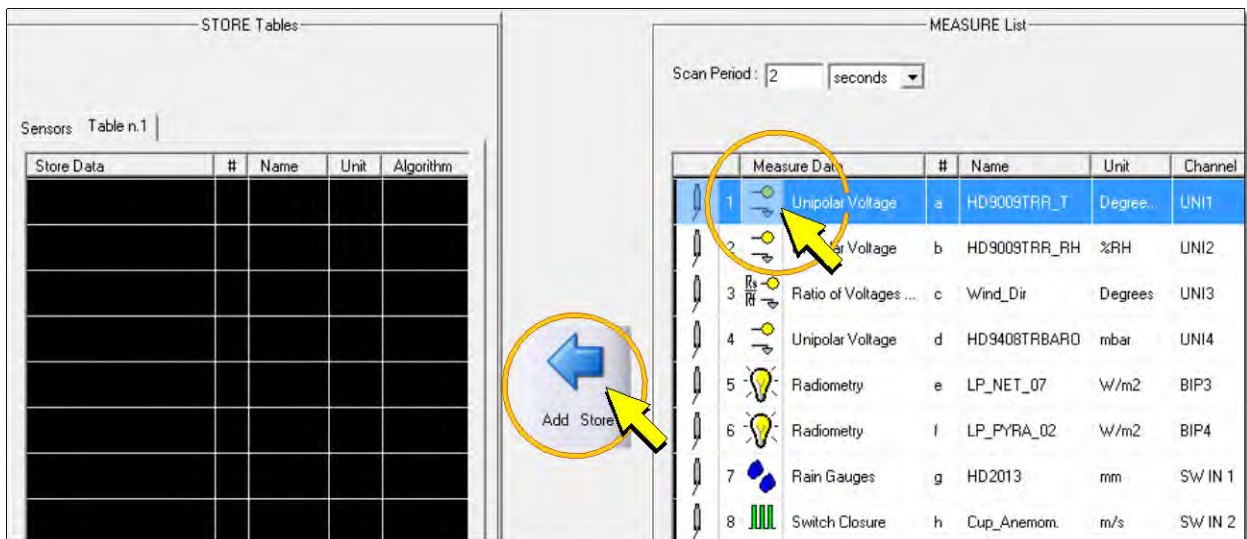

3. The window for selecting the type of value to be stored appears. Select the desired option from the following:
 - *OneSample* stores the last instant value acquired.
 - *Average* stores the average of the values acquired between two successive recording instants.
 - *Max* stores the maximum of the values acquired between two successive recording instants.
 - *Min* stores the minimum of the values acquired between two successive recording instants.
 - *Total* stores the sum of the values acquired between two successive recording instants. It is used in case of pulse inputs to store the total number of pulses counted.

- o *StDeviation* stores the standard deviation of the values acquired between two successive recording instants.
- o *ETo* stores the standard evapotranspiration and the quantities used for the calculation (the option is enabled only if the evapotranspiration measurement has been selected).
- o *Alarms* stores the alarm condition of the measurement.



Depending on the type of measurement, some of the options might be disabled if they are not significant for the measure. The *Alarms* button is disabled if the table already contains a type of storage different from the alarm condition (please see paragraph 9.4.1 on page 108 for the creation of the alarms table).

4. After choosing the type of value to be stored, the measure is added to the store table, and above the table appears the recording interval (*Store Period*). Write the desired interval. If necessary, select minutes (*minutes*) or seconds (*seconds*) as unit of measurement for the interval.



The recording interval (*Store period*) must meet the following conditions:

- o Be between 2 and 60 seconds or between 1 and 1440 minutes (24 hours).
- o Be equal to or multiple of the acquisition interval (*Scan Period*).



If you set a recording interval that is not a multiple of the acquisition interval, an error message appears: *Store Period must be multiple of Scan Period!*. In this case, press *OK* and set a correct interval value.

The recording interval is associated with the table that is being defined and it is common to all measures in the table. Each table has its own recording interval that can be the same or different compared to other tables that may be present.

5. Proceed according to steps 2 and 3 to add further measures to the store table.

Note: the type of stored value (*OneSample, Average, etc.*) may be different from measure to measure. In addition, the same measure can be added multiple times to the same table with different types of value to be stored.

To remove a measure from a store table, select it and press *Remove store*.

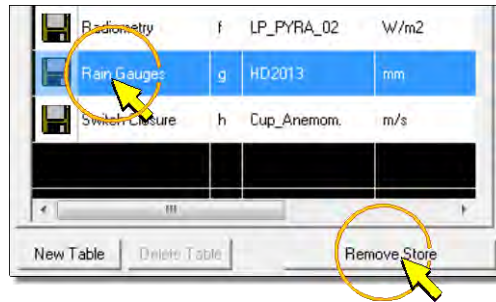

If you want to store some of the measures at different intervals than others, you can split the measures into multiple tables, setting the required interval for each table.

The same measure may also appear in multiple tables.

If there are many measures to be stored with the same interval, for your convenience you can also divide them into multiple tables by setting the same recording interval for the various tables.

To create further tables after the first one, select the *New Table* button at the bottom left. This opens an empty table (with a sequential number following the last created table) in which you can enter the measurements you want.

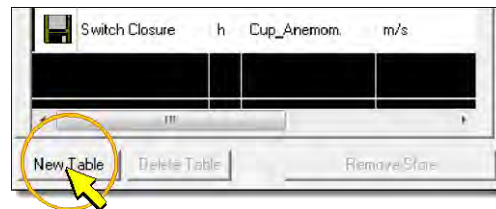

The program can contain up to 8 store tables.

To delete the last created table, select the *Delete Table* button below the table, then press *Yes* when the message asking you to confirm the operation appears.

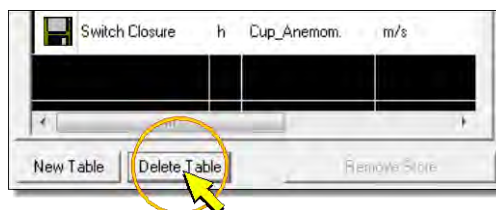

You can only delete the table with the highest sequential number among those present. You can not delete the table number 1, even if empty.

WARNING MESSAGES

During the insertion of the measures in the store tables, the following messages may appear:

- *Scan Period too short !*

The message appears when the number of measurements becomes too high to be able to acquire all the measures between two successive acquisition instants. The measure that you are trying to enter will **not** be added to the table. Press *OK* to return to the program window. To insert additional measures it is necessary to increase the acquisition interval in the *Scan Period* field.

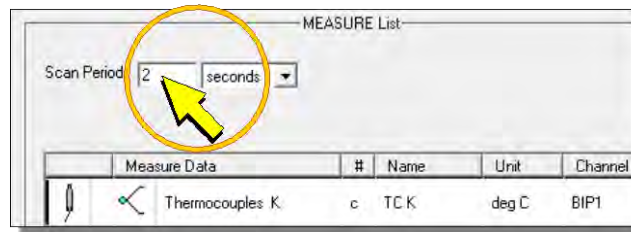

- *Total Store Data over 30 reached !*

The message appears when you try to insert a measure, but there are already 30 measures present.

9.4.1 ALARMS TABLE

To create a table of alarms, select an empty table, then add the measurements you want by choosing the *Alarms* option.

Selecting the *Alarms* option, a window appears that allows you to set the values of the two alarm thresholds, lower and higher, and the associated alarm outputs to be activated.

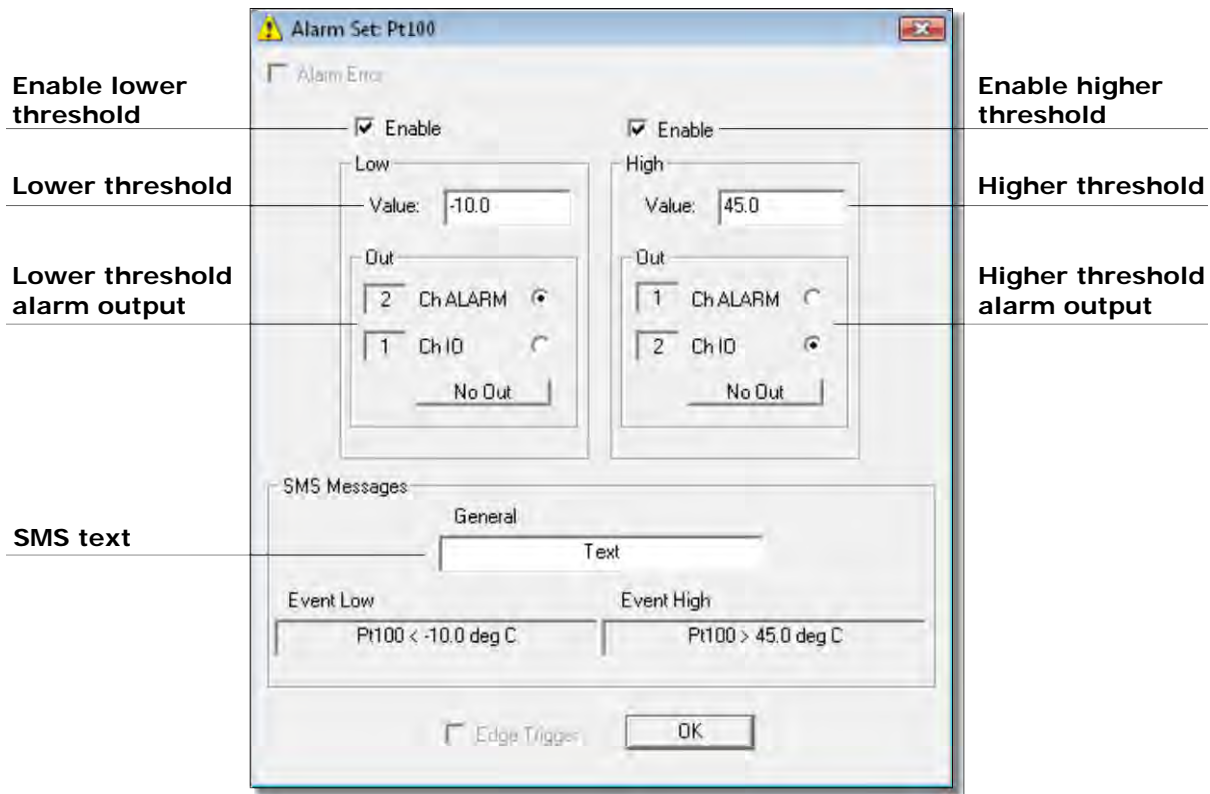

Select the *Enable* boxes to enable the thresholds. The alarm condition occurs if the value falls below the lower threshold or rises above the upper threshold.

The alarm outputs are independent for the two thresholds. As alarm outputs you can use the digital I/O ports, by selecting the *Ch IO* option, or the potential-free contact alarm outputs, selecting the *Ch ALARM* option. The output number, shown to the left of the option is assigned automatically by the software, it is not allowed the manual setting. If you do not want to assign an alarm output, select *NO Out*. If you do not select any output option, the software automatically assigns the *NO Out* option.

Each alarm output is related to a single threshold. It is not allowed to assign the same output to two different thresholds, even if they related to the same measure.

Alarm conditions are always all stored according to the set recording interval for the table, regardless of the assignment or not of corresponding outputs.

If the data logger is connected to a GSM device, when an alarm condition occurs, the data logger can send an alert SMS. The SMS text consists of the text entered in the field *General*, followed by the text (not editable) of the *Event Low* or *Event High* field depending on the alarm condition present.

Press *OK* to add the alarm conditions to the table.

Alarm conditions to be stored must all be entered in the same table. Tables dedicated to the storage of measured values can not contain storing of alarm conditions. If a table already includes the storage of a measured value, the *Alarms* button is disabled when adding other measures to the table. Similarly, if the table stores alarm conditions, it can not contain recordings of measured values. If a table already contains the storage of an alarm condition, only the *Alarms* button is enabled when adding other recordings to the table.

You can change alarm conditions already entered by double clicking on the rows of the table (*note*: the SMS text is visible only if the sending of the SMS is enabled).

To the alarm thresholds it is applied an hysteresis of $\pm 1\%$ of set value. The difference between the two thresholds can not be less than 2% of the value of the lower threshold.

ALARMS RELATED TO DIGITAL INPUTS

In the case of digital inputs, only one thresholds can be enabled. Enabling the lower thresholds, there is the alarm signal when the input is at logic state 0. Enabling the higher thresholds, there is the alarm signal when the input is at logic state 1. If both thresholds are enabled, an error message appears when pressing *OK* to confirm.

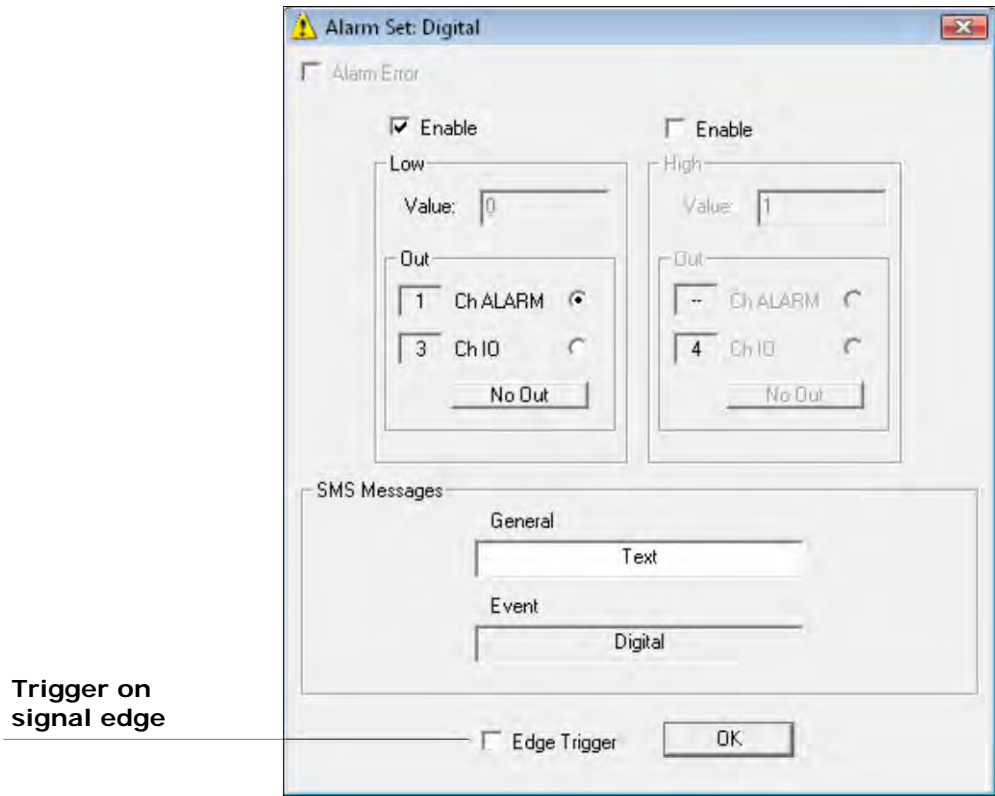

Trigger on
signal edge

By selecting the *Edge Trigger* box, the alarm is triggered only after a state change of the input signal (from 1 to 0 if the lower thresholds is enabled, from 0 to 1 if the higher thresholds is enabled). This allows to prevent false alarms at system power on: if the digital input is in the alarm state at datalogger power on, the alarm is not triggered immediately but the datalogger waits for the alarm condition to stop and occur again later (with the *Edge Trigger* box not selected, instead, the alarm would be triggered immediately at power on).

ALARMS RELATED TO MEASUREMENT OR SYSTEM ERRORS

By selecting the *Alarm Error option*, there is the alarm signal when a measurement (e.g. due to a not working sensor or wrong connection) or system (data logger failure) error occurs.

The *Event* field of the SMS will contain the error code and, in the case of sytem error, the type of error in square brackets.

To activate the alarm when an error occurs or the measurement thresholds are exceeded, the measurement has to be added twice to the alarm table: once with *Alarm Error* option enabled and once with the *Alarm Error* option disabled.

Alarm when system or measurement errors occur

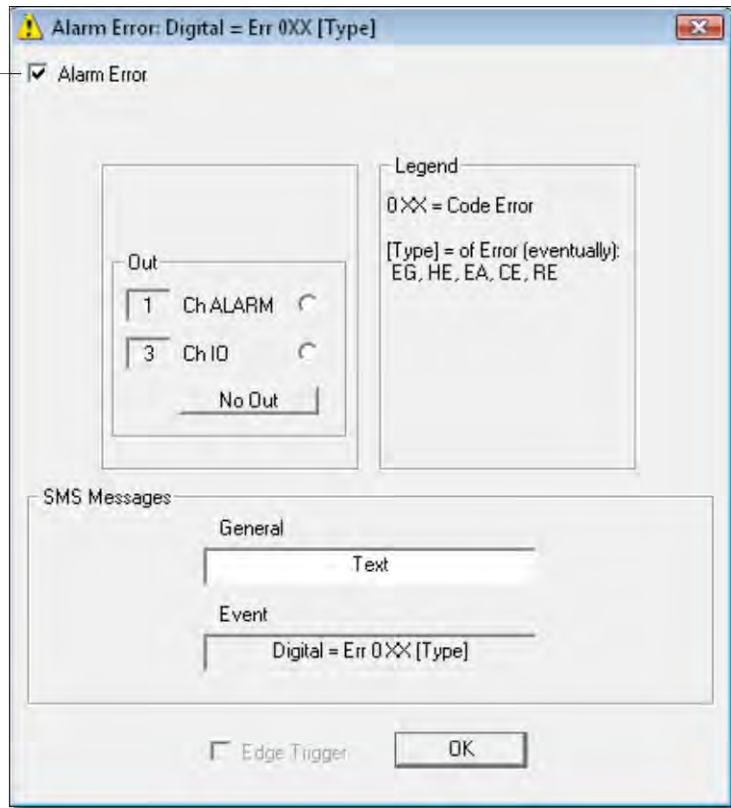

During the alarm condition, the error code is displayed and stored instead of the value of the measurement.

ENABLING THE SMS

To enable the sending of SMS messages you must apply the check mark in the *Enable SMS* option.

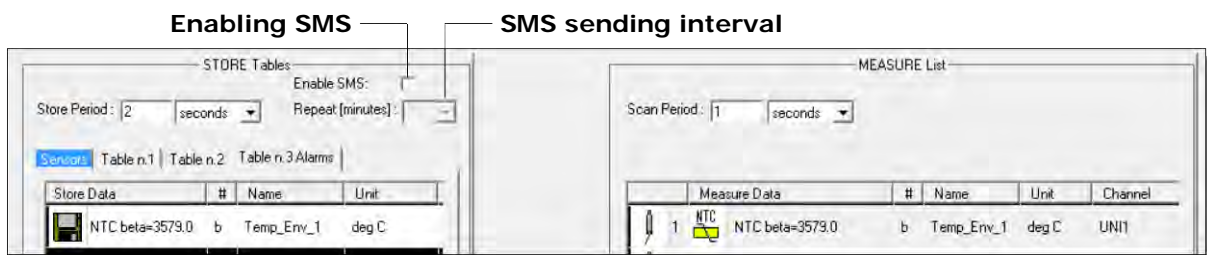

In the *Repeat* field, set the time interval between the sending of successive alarm SMS, in the case the alarm condition persists over time.

After an alarm condition has occurred and the corresponding message has been sent, no further SMS will be sent until the set *Repeat* interval has elapsed, even if other alarm conditions occur. If at the time to send the SMS alert more of an alarm condition is present, it is sent only the SMS corresponding to the alarm condition that occurred first.

If at the expiration of the *Repeat* interval the alarm condition is no longer present, the SMS is not sent.

The setting of the *Enable SMS* option and *Repeat* interval is unique for all measures. The SMS alert is available only for the first 16 measures of the table.

For the setting of phone numbers to which the SMS messages should be sent, refer to the manual of the HD32MTLogger application software.

Note: SMS messages are not sent if the logger is connected to the PC and there is an ongoing communication session.

9.4.2 CAPACITY OF THE INTERNAL MEMORY

The HD32MTLogger software calculates the time needed to fill the data logger internal memory as a function of the set recording intervals and the number of tables and measures to store. The time is calculated when you press the *Create* button to save the program file, or the *Print* button to print the wiring diagram or the store tables. The time is displayed in the lower right side of the program window and is estimated in days.



The internal memory is managed in a circular manner, when the memory is full, the new data will overwrite the oldest.

Note: you can extend the memory capacity and prevent loss of data using a removable SD type memory card (up to 8 GB). See chapter 11 on page 123 on how to use the card.

The following describes how to estimate in advance, before preparing the program, how much data can be stored in the internal memory and for how long, so to evaluate how many sensors to use in the system.

The data logger has an internal memory of 4 MB. Storing a measurement requires 4 bytes. Storing the date/time requires 6 bytes. For a table containing N measurements, each store requires $[(4 \times N) + 6]$ bytes.

PROGRAM WITH ONE STORE TABLE

If the program has only one table, the internal memory will fill up after a MEM number of recordings equal to:

$$MEM = \frac{4MB}{(4 \times N) + 6}$$

If T is the recording interval of the table, the memory will be filled after the time:

$$MEM \times T$$

Example

Suppose that the data logger program has only one table with 8 measures and recording interval of 30 seconds.

The number of recordings possible before you fill the internal memory is:

$$MEM = \frac{4MB}{(4 \times 8) + 6} \approx 110,000$$

The time required to fill the memory is $\approx 110,000 \times 30$ seconds ≈ 38 days.

PROGRAM WITH TWO STORE TABLES

If the program has two tables you need to consider the difference between the two recording intervals.

Let's say N_1, T_1 and N_2, T_2 are the number of measures and the recording interval of the first and second table respectively. The number of recordings MEM1 and MEM2 of the two tables needed to fill the memory is given by:

$$\text{MEM}_1 = \frac{4\text{MB}}{(4 \times N_1) + 6 + \left[\frac{T_1}{T_2} \times ((4 \times N_2) + 6) \right]} \quad \text{MEM}_2 = \frac{1\text{MB}}{(4 \times N_2) + 6 + \left[\frac{T_2}{T_1} \times ((4 \times N_1) + 6) \right]}$$

The memory will fill up after the time: $\text{MEM}_1 \times T_1 = \text{MEM}_2 \times T_2$

Example

Suppose the data logger program has two store tables. The first with $N_1=6$ measurements and interval $T_1=1$ minute, the second with $N_2=2$ measurements and interval $T_2=2$ minutes.

The number of records to fill the internal memory is:

$$\text{MEM}_1 = \frac{4\text{MB}}{(4 \times 6) + 6 + \left[\frac{1}{2} \times ((4 \times 2) + 6) \right]} \approx 110,000 \quad \text{MEM}_2 = \frac{4\text{MB}}{(4 \times 2) + 6 + \left[\frac{2}{1} \times ((4 \times 6) + 6) \right]} \approx 55,000$$

The internal memory will contain $\text{MEM}_1 + \text{MEM}_2 \approx 165,000$ records.

The time required to fill the memory is $\approx 55,000 \times 2$ minutes ≈ 76 days.

PROGRAM WITH MULTIPLE STORE TABLES

In general, if a program has k tables, before filling the memory, the i -th table will be recorded for a number of times equal to:

$$\text{MEM}_i = \frac{4\text{MB}}{\left[\frac{T_i}{T_1} \times ((4 \times N_1) + 6) \right] + \left[\frac{T_i}{T_2} \times ((4 \times N_2) + 6) \right] + \dots + \left[\frac{T_i}{T_k} \times ((4 \times N_k) + 6) \right]} \quad \text{con } i=1,2,\dots,k$$

The time needed to fill the memory is: $\text{MEM}_i \times T_i$ and the memory will contain a number of records equal to $\text{MEM}_1 + \text{MEM}_2 + \dots + \text{MEM}_k$.

9.5 SAVING THE PROGRAM IN THE PC

After you define the list of sensors (*MEASURE List*) and the *STORE Tables*, with its acquisition (*Scan Period*) and recording (*Store Period*) intervals, you must save to your PC the file of the program of measures and recordings, for subsequent installation in the data logger.

1. Press *Create* to save the program and generate the file needed by the data logger.

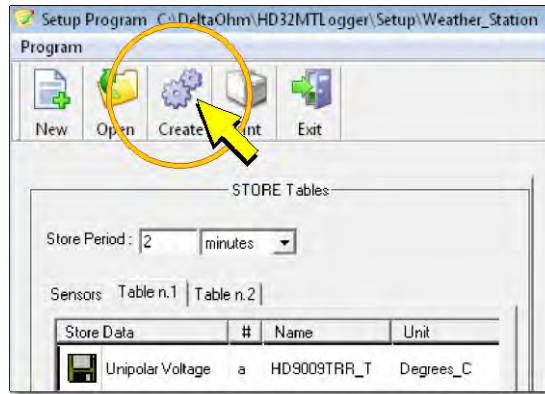

The window that allows you to specify the file name and path where to save it to your PC appears. After saving, a summary report is displayed, press *OK* to return to the program window.

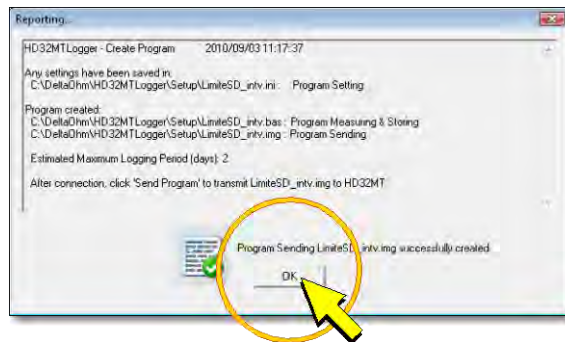

2. Verify that the time (in days) needed to fill the data logger internal memory, displayed in the lower right side of the program window is sufficient for your application.

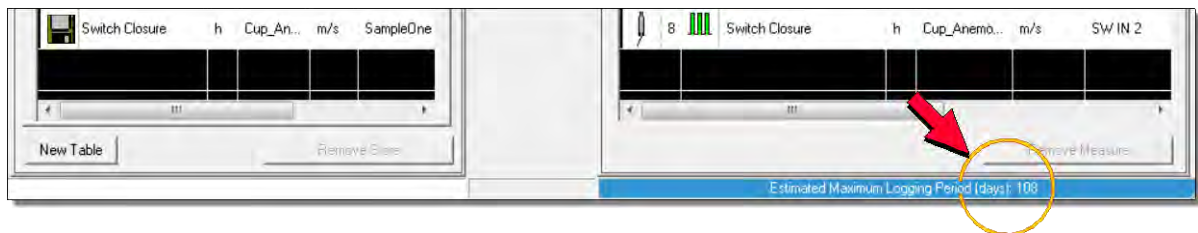

3. Select *Print* to print the wiring diagram and/or the store tables.



Then select *Print Wiring Diagram* to print the wiring diagram or *Print Tables Store* to print the store tables. Press *OK*.

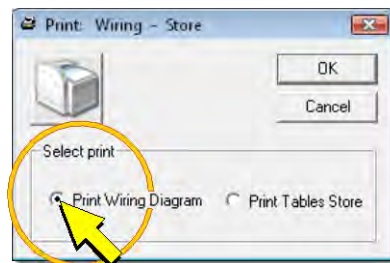

4. Press *Exit* to close the program window.

With the *Create* button, the program is saved in multiple versions with the same name but different extension. In particular, it generates a file with extension "*ini*" and a file with extension "*img*". The file with extension "*img*" contains the program in a format readable by the data logger, and is therefore the file to be installed later in the data logger. The file with extension "*ini*" contains the program in text format, and is the file that is opened by the HD32MTLogger software when you have to make changes to the program.

To save the program without generating the file to install in the data logger, for example because you have not yet completed it, select the *Exit* button directly instead of *Create*. The software will ask the name and location to save the file, and only the "*ini*" format will be saved.

If you want to change a previously saved program, before installing it in the data logger, select the *Program Setup* command in the main window of HD32MTLogger software, then choose *OPEN Program*, select the program previously saved (file with extension "*ini*") and press *Open*.

Note: If you select *Create* with blank store tables, a warning message appears: *No STORE Tables or empty Tables, confirm creating ?*. If you proceed, the file for the logger is created anyway, but the program will only make the measurements without saving them.

9.6 INSTALLING THE PROGRAM IN THE DATA LOGGER

To make the program operational you need to install it into the data logger.

Warning: the installation of a program in the data logger erases all measurements recorded in the internal memory. So as not to permanently lose the data recorded in the internal memory, you should transfer them to the PC using the "Dump LOG" command of the HD32MTLogger software, before beginning the program installation. The measurements stored in the removable SD memory card, if any, will remain recorded.

To install the program in the data logger, proceed as follows:

- 1 Power up the logger and connect it to your PC (directly, via modem or via local network) by following the instructions in chapter 6 on page 38.
- 2 If the datalogger is connected directly to a RS232 or USB port of the PC, or it is connected through a Radio Modem, select the *Serial Connection* item in the *Tools* menu to configure the connection.

If the datalogger is connected through a Local Area Network with TCP/IP protocol or through Internet with IP modem, select the *TCP/IP connection setup* item in the *Tools* menu to configure the connection.

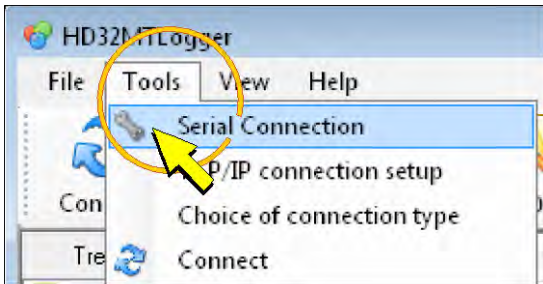

Direct or Radio Modem connection

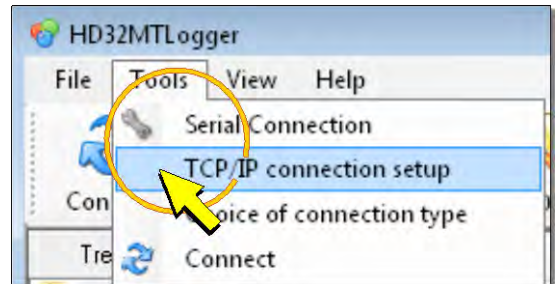

Local network or IP modem connection

- 3 Configure the connection as follows:

3.1 Direct or Radio Modem connection configuration:

In the *Connection Properties* window, apply the check mark next to the *Radio Modem* entry for the model with Radio Modem option. For the base model, make sure the check mark is not present, possibly by clicking on the box next to the entry to deselect it.

Model with Radio Modem option

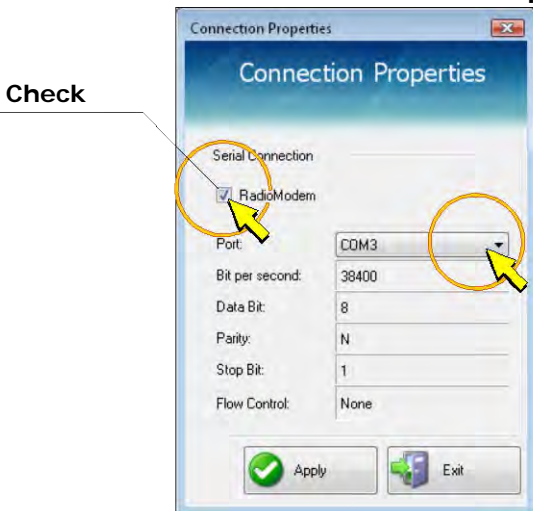

Basic model

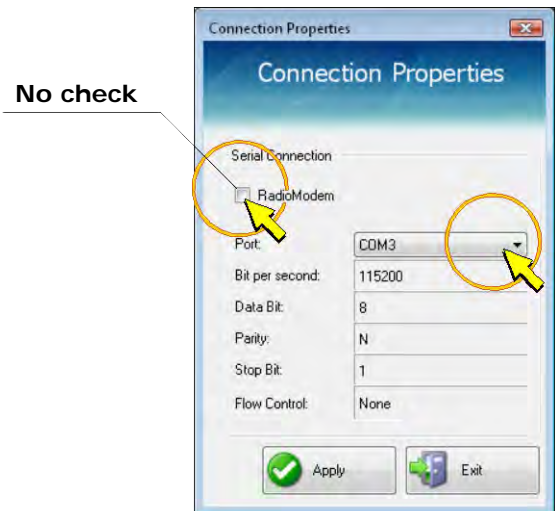

Select the COM port number of the PC which is connected to the instrument or radio modem, then click *Apply* to return to the main window.

If the COM port number is not known, leave the setting unchanged and press *Apply* to

exit, the program will automatically search for an instrument connected to the available ports on your PC, starting from the set one.

Note: the remaining communication parameters are fixed, the difference between the two models of data loggers is the data transfer rate (bits per second): 38400 for the model with radio modems and 115200 for the base model.

3.2 Configuration of local network or Internet with IP modem connection:

In the *TCP/IP connection setup* window, set the *IP address* (only for local network connection) and *Port* fields. The values must be equal to those set in the RS232/Ethernet adapter or in the IP modem. Press *Apply* to store the configuration. Press *Exit* to return to the main window.



- 4 Select the *Choice of instrument model and connection type* item in the *Tools* menu.

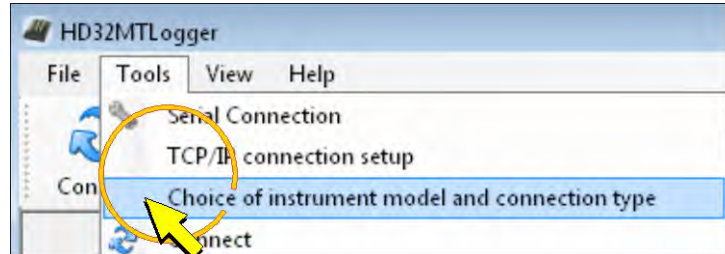

- 5 Select the model **HD32MT.1**. Select *Serial connection* if the datalogger is connected directly to a RS232 or USB port of the PC, or it is connected through a Radio Modem. Select *TCP/IP client connection* if the datalogger is connected through a Local Area Network with TCP/IP protocol and RS232/Ethernet adapter. Select *TCP/IP server connection* if the datalogger is connected through Internet with IP modem.

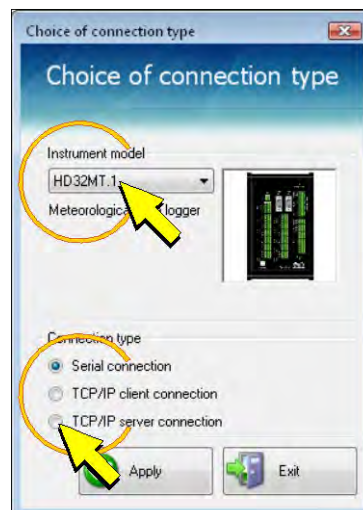

Press *Apply* to store the choice. Press *Exit* to return to the main window.

- 6 Press the *Connect* icon in the toolbar.



- 7 If the connection is successful, the software reads the program installed in the datalogger and asks to enter the password. Write the password in the *Password* field and press *OK*. The factory default password is 00000000 (8 zeros).



Note: by pressing *Cancel* or *OK* without entering the password or *OK* with wrong password, it will not be possible to change the data logger settings. By pressing *OK* with wrong password, an error message will appear; to insert the password again, disconnect and connect again the data logger.

- 8 After the connection, the *DataLogger Information* window is displayed, which lists in the order: data logger model, serial number, firmware version, the name of the program installed in the data logger, the measurements acquisition interval (*Scan period*) and the number of store tables (*STORE Tables*).

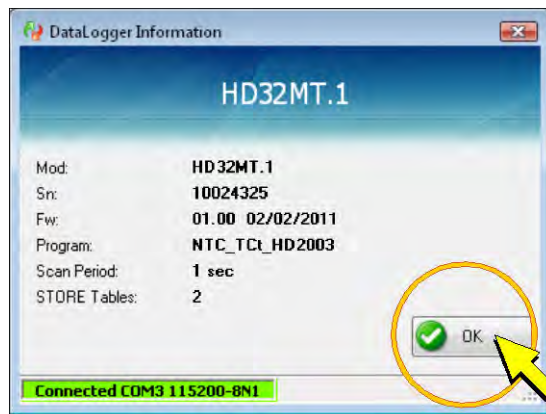

Press *OK* to return to the software main window.

Note: if you attempt a connection while the logger is recording data in the SD memory card, you receive a warning message (*SD Card Running*). In this case, wait a few minutes and try to press the *Connect* icon again.

Note: if the logger has no program installed, the message *Absent* or *UnHook!* appears when connecting, to remember the need to install a program. Ignore it and continue with the installation.

If you experience connection errors, follow the instructions of paragraph 9.6.1 on page 119.

9 Select the *Send Program* icon.



10 In the window that opens, the *scheduling* option is used to activate periodically one of the two alarm output ALARM 1 or ALARM 2 to power the IP modem, if present in the system (see the paragraph 6.6 on page 42). If the alarm output is not used to power the modem, select *No scheduling*, otherwise select *Start scheduling* and set the fields in the window (see the software instructions).

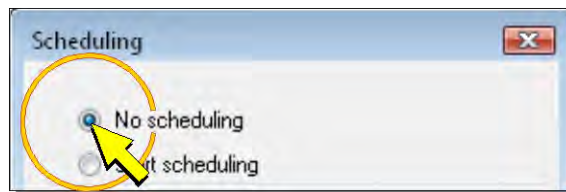

11 Press *Send*.

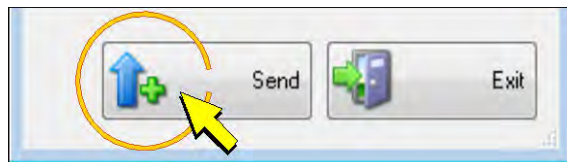

12 In the window that opens, select the name of the previously saved program (with extension *.img*) and press *Open*.

A message appears to remind you that the stored data will be lost. Press *Yes* to continue.

13 Wait until the program is installed in the data logger (a progress bar indicates the installation status). If the installation is completed successfully, the *DataLogger Information* window is displayed again. Click *OK* to exit. The program installed starts automatically to operate in the data logger, acquiring and storing the programmed measurements.

Note: the program already existing in the data logger is cleared at the beginning of the installation of the new program. If error messages appear during installation and the installation process is interrupted, the data logger is left without a working program. In this case you must repeat the installation procedure.

14 To end the communication session between the PC and data logger, select the *Disconnect* icon.

9.6.1 ERROR MESSAGES DURING CONNECTION

If the connection fails, the message *HD32MT Not Found!* appears. In this case, check the following points:

- In the connection properties, check that the correct data logger model was set (option with or without Radio Modem) and that the COM port to which the data logger is connected is selected.
- Check the PC connections are correct according to the instructions in chapter 6 on page 38.
- To connect via radio modem, check that the antennas are not positioned too far away from each other and that there are no obstacles that can limit the transmission equipments range.

If the connection is successfully established initially, but then of interruption occurs, the following messages may appear:

- *TIMEOUT CMD OVER 7 Attempts!* (Command times out after 7 attempts)
- *No Answer after CMD!* (No response after the command)
- *ERROR: communication at ... block* (Communication error at the block....)
- *HD32MT Not Connected or Program Error!*

In these cases retry the connection, possibly checking the status of the electrical connections.

10 "MODBUS SLAVE" MODE

The data logger can communicate through the PC COM port in "Modbus Slave" mode with **Modbus-RTU** or **Modbus-TCP/IP** protocol. To set the data logger as "Modbus Slave" unit:

1. In the program of measures and loggings select the *Sensors* panel, expand the *Protocols* folder, then select *Modbus RTU-TCP/IP Slave* and make a click on the *Add Measure* button with the green arrow at the center of the window (or alternatively, double-click on *Modbus RTU-TCP/IP Slave*).

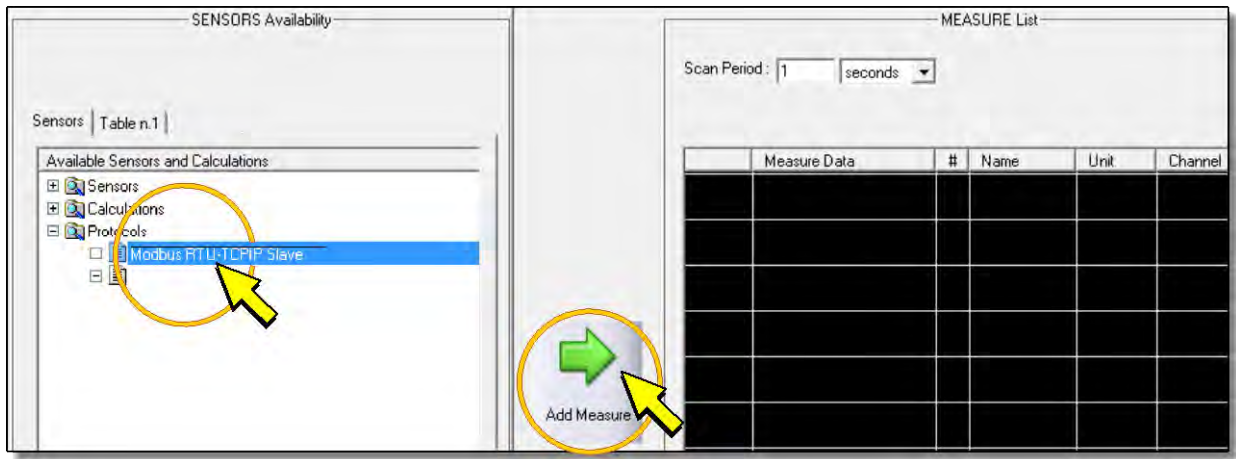

2. The configuration window appears. Fill in all fields and press *OK*, the "Modbus Slave" mode is added in the *MEASURE List* panel.

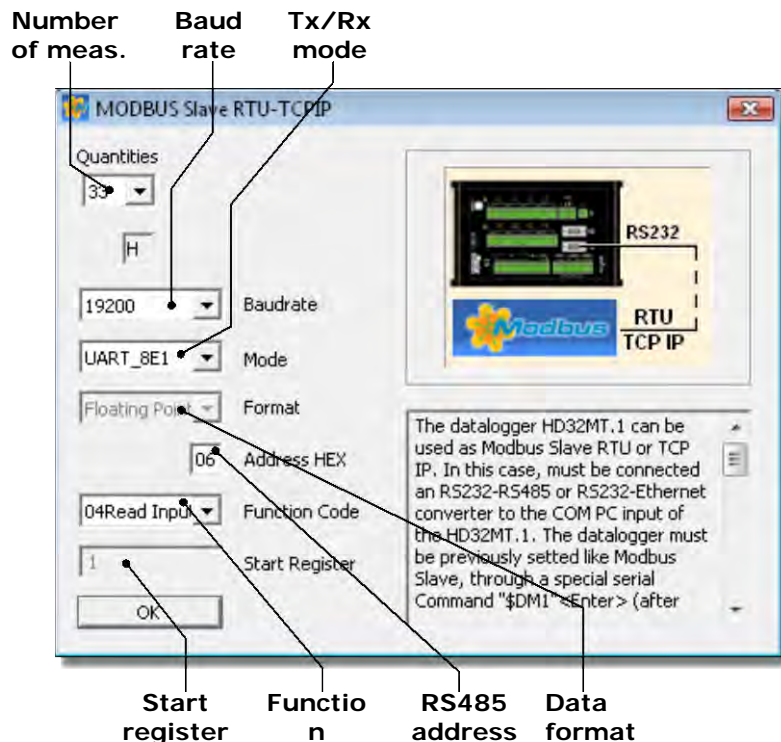

- **QUANTITIES** (NUMBER OF MEASURED QUANTITIES)

Number of physical quantities acquired by the data logger. The value can not be set and is equal to the number of measurements in the *MEASURE List*.

- **BAUD RATE**

Select the communication speed of the data logger.

- MODE (COMMUNICATION PARAMETERS)

Select the communication parameters. The following options can be selected:

- UART_8N1: no parity, 1 stop bit
- UART_8E1: even parity, 1 stop bit
- UART_8O1: odd parity, 1 stop bit
- UART_8N2: no parity, 2 stop bits
- UART_8E2: even parity, 2 stop bits
- UART_8O2: odd parity, 2 stop bits

- FORMAT (FORMAT OF DATA)

Can not be set. Format of the data transmitted by the data logger (Floating Point 4B: 4 Bytes).

- ADDRESS

Data logger RS485 address.

- FUNCTION CODE

Function code of the Modbus command sent by the "Master" unit. Select the option "04 Read Input Registers".

- START REGISTER

Can not be set.

3. Save to your PC the file of the program of measures (after completing the list of sensors), for subsequent installation in the data logger (please refer to paragraph 9.5).
4. Connect the COM PC port of the data logger to your PC and start a serial communication program, as Hyperterminal for instance. Set the Baud Rate to 115200 (38400 if the data logger has the Radio Modem option) and set the communication parameters 8N1.
5. Send the serial commands:

\$DP*password* (\$DP00000000 if the password is the default one)

\$DM1 (the PC replies with the characters \$!&)

6. Close the serial communication program and install, with the help of application software HD32MTLogger, the program of measures in the data logger (please refer to paragraph 9.6).

Note: after installing the new program, the communication between the data logger and the application software HD32MTLogger is interrupted.

7. Turn the data logger off and on. The "Modbus Slave" mode will become active after 10 seconds from restart.

Note: in "Modbus Slave" mode the data logger does not store the measures (the measures are sent to the "Modbus Master" unit on request).

COMMUNICATION WITH THE HD32MTLOGGER SOFTWARE

When in "Modbus Slave" mode, the data logger does not communicate with the HD32MTLogger software. To temporarily disable the "Modbus Slave" mode:

1. Connect the COM PC port of the data logger to your PC and start a serial communication program, as Hyperterminal for instance. Set the Baud Rate to 115200 (38400 if the data logger has the Radio Modem option) and set the communication parameters 8N1.
2. Turn the data logger off and on. When started up, the data logger remains waiting for a serial command for 10 seconds: send the command **\$#** to the instrument before 10 seconds have elapsed.

Note: if the data logger doesn't receive the over mentioned command within 10 seconds from start up, the "Modbus Slave" mode is automatically activated.

3. Close the serial communication program and connect the HD32MTLogger software.
4. When you are finished using the HD32MTLogger software, turn the data logger off and on. The "Modbus Slave" mode will become active after 10 seconds from restart.

DISABLING THE "MODBUS SLAVE" MODE

To permanently disable the "Modbus Slave" mode:

1. Connect the COM PC port of the data logger to your PC and start a serial communication program, as Hyperterminal for instance. Set the Baud Rate to 115200 (38400 if the data logger has the Radio Modem option) and set the communication parameters 8N1.
2. Turn the data logger off and on. When started up, the data logger remains waiting for a serial command for 10 seconds: send the command **\$#** to the instrument before 10 seconds have elapsed.

Note: if the data logger doesn't receive the over mentioned command within 10 seconds from start up, the "Modbus Slave" mode is automatically activated.

3. Send the serial commands:

\$DP*password* (\$DP00000000 if the password is the default one)

\$DMO (the PC replies with the characters \$!&)

4. Close the serial communication program and open the HD32MTLogger software.
5. In the program of measures, remove the row *Modbus RTU-TCP/IP Slave* in the *MEASURE List* panel.
6. Save to your PC and install in the data logger the program of measures and recordings.

11 MEMORY CARD

The data logger is equipped with a reader for removable SD memory card, located at the top of the instrument (point 12 of the figure on page 9).

You can use memory cards up to a capacity of 8 GB.

The use of a memory card allows you to greatly increase the capacity of the data logger to store data, avoiding a possible loss of data due to the filling of internal memory.

To use a memory card it is sufficient to insert it the appropriate slot (push the card until a click is heard, which guarantees the correct insertion). The logger automatically detects the presence of the card and will use it to store measurements.

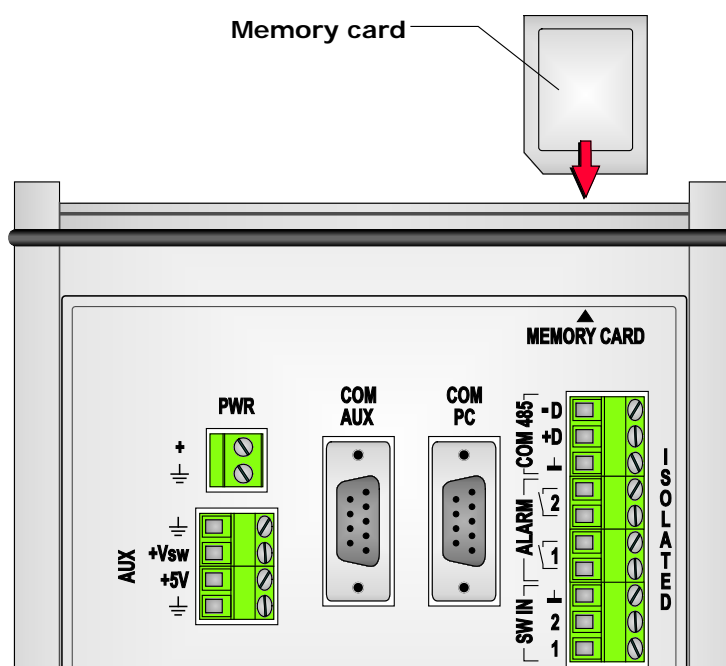

When a card is inserted, the data logger verifies that it is writeable. During verification, the LED next to the card turns red. Make sure that after a few seconds from the card insertion the LED turns green. If the LED does not become green after inserting the card, but emits red flashes, verify the correct insertion of the card and replace it if necessary.

Unlike the internal memory in which data are written at each recording interval, data in the memory card are written once every 15 minutes (at 0:15, 0:30, 0:45, 1:00, 1:15, etc.). The memory card will then contain many files, each of which contains all the measurements stored by the data logger in a quarter of an hour (or longer if you have set the file appending option for GSM transmission, see the HD32MTLogger software instructions for the appending functionality).

Since the internal memory fills up normally in a period greater than a quarter of an hour, the transfer of the measures in the memory card allows to store data in an almost permanent way (at least until the memory card capacity is reached).

The measures contained in different store tables are saved in separate files. Every 15 minutes as many files as the number of store tables in the data logger program are created. The file names are formed by the table number to which they refer followed by a sequential number.

When writing files on the memory card, the LED located next to the card turns red, indicating that the write operation is in progress. Do not remove the memory card when the LED is red, to avoid damage to the contents of the card. The card can be removed when the LED is green.

Note: if the memory card is not inserted, the LED will emit five red flashes every quarter of an hour, indicating the absence of the card.

The files on the card can be transferred to a PC equipped with an SD memory card reader. To transfer files, remove the card from its slot (push the card firmly until you hear a click and then release it), and insert it into your PC.

The HD32MTLogger software has a special feature called *Merge Files*, which lets you combine multiple files related to the same store table into one file. To use this function, please refer to the software manual.

Note: when writing in the card, the logger can not connect to the PC. If you try to connect while writing, you will receive the *SD Card RUNNING* message. In this case, wait for the write process to be completed before retrying the connection.

If the data logger is equipped with a GSM module, the use of the memory card is required to transmit data via the GSM device, since the data transmitted are those that are stored in the card.

12 LED SIGNALS

The LED next to the SD memory card provides various signals to indicate the status of the data logger or any abnormalities that may occur. The following table summarizes the meaning of the signals.

LED Signal	Meaning
ON red fixed	Writing in the memory card in progress
2 s ON red / 2 s OFF	Detected hardware problems at startup
1 s ON red / 1 s OFF	Detected problems in the operation program loaded
1 quick red blink once per second, OFF the rest of the time	Low consumption mode due to supply voltage drops below 11.7V
5 blinks 1 s ON red/ 1 s ON green	The SD memory card is not inserted. The flashes are emitted at startup or when trying to access the card.
10 blinks 0.5 s ON red / 0.5 s ON green	The SD memory card is inserted but it was not possible to access it at the time of writing
1 quick red blink on startup and then green fixed	Data logger basic model detected
1 long red blink of 5 s on startup and then green fixed	Data logger model with Radio Modem option detected
10 quick double red blinks on startup	Waiting time for stabilization of the +Vsw supply output
20 quick double red blinks	Exit low power mode and return to normal operation

13 HOUSING OPENING ALARM

The outdoor housing for the data acquisition system can be supplied with an **optional** sensor (**HD32MT.ALM**) able to detect the opening of the door of the housing and provide an alarm signal.

The sensor is connected to one of the data logger digital inputs (see point 6 of the terminal board figure on page 9 for the digital inputs location).

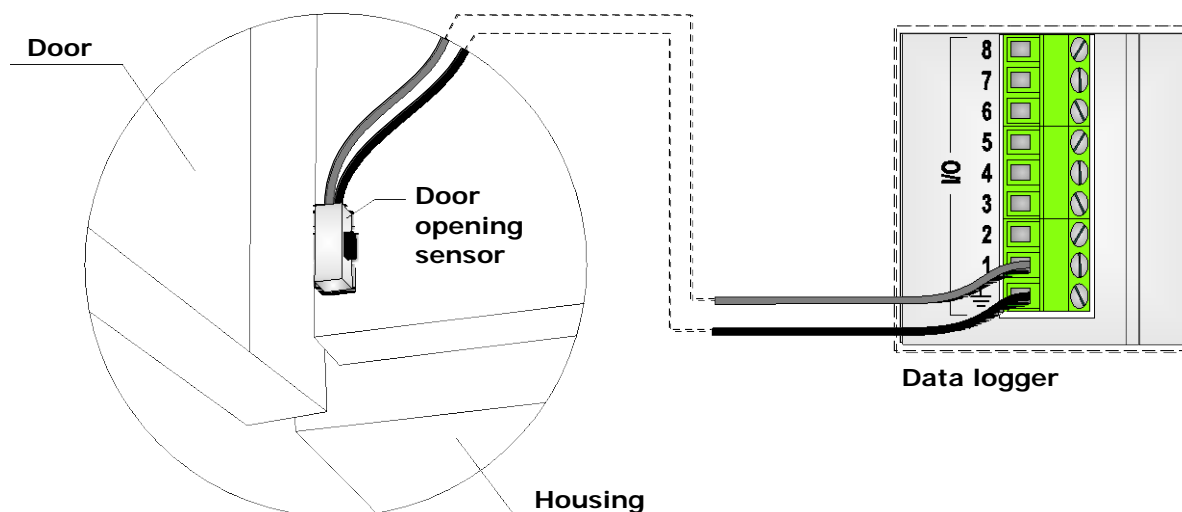

The principle of operation of the sensor is shown below:

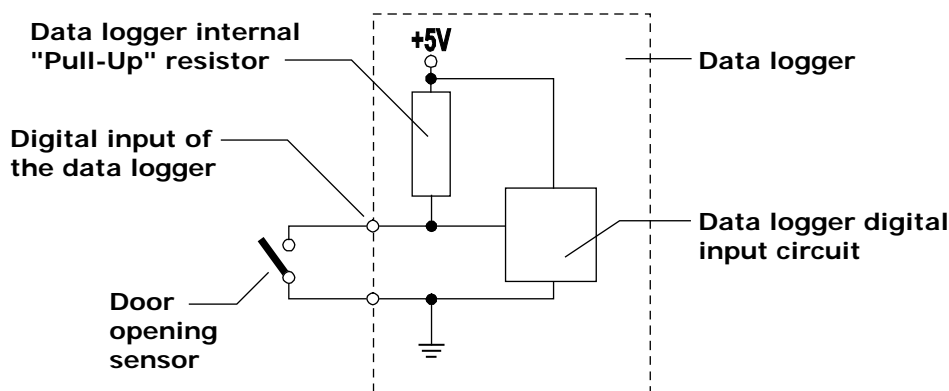

The digital input of the data logger detects the status of the sensor contact. If the input of the logger is in the logic state 0 (closed contact) means that the door is closed. When the housing door is opened, the input of the data logger goes to logic state 1 (open contact).

To record in the data logger memory the opening/closing state of the housing door, the sensor must be included into a store table of the data logger program of measures and recordings (see paragraphs 9.2.7 "Digital Input Configuration" and 9.4 "Creating the store tables").

To be able to signal the alarm (also via SMS, if the system has the GSM module), the sensor must be inserted in the alarms table (see paragraph 9.4.1 "Alarms Table").

In case of delivery of a system with door opening sensor and data logger with preinstalled program, the data logger is already configured for the operation of the sensor.

14 DISPLAY

It is possible to connect an **optional** LCD display to the data logger, to check the values acquired by the data logger without having to connect your PC.

The display is available in the basic version (**HD32.D**), or with the GPS option (**HD32.D.GPS**) to automatically update the clock of the data logger.

The displays **HD32.D** and **HD32.D.GPS** are designed for being fixed to the outdoor housings HD32.35, HD32.35FP, HD32.36 and HD32.36FP.

The supply voltage required by the display is 8...30 Vdc.

The display connects to the data logger **COM PC** RS232 serial port via the cable with 9-pin female SubD connector.

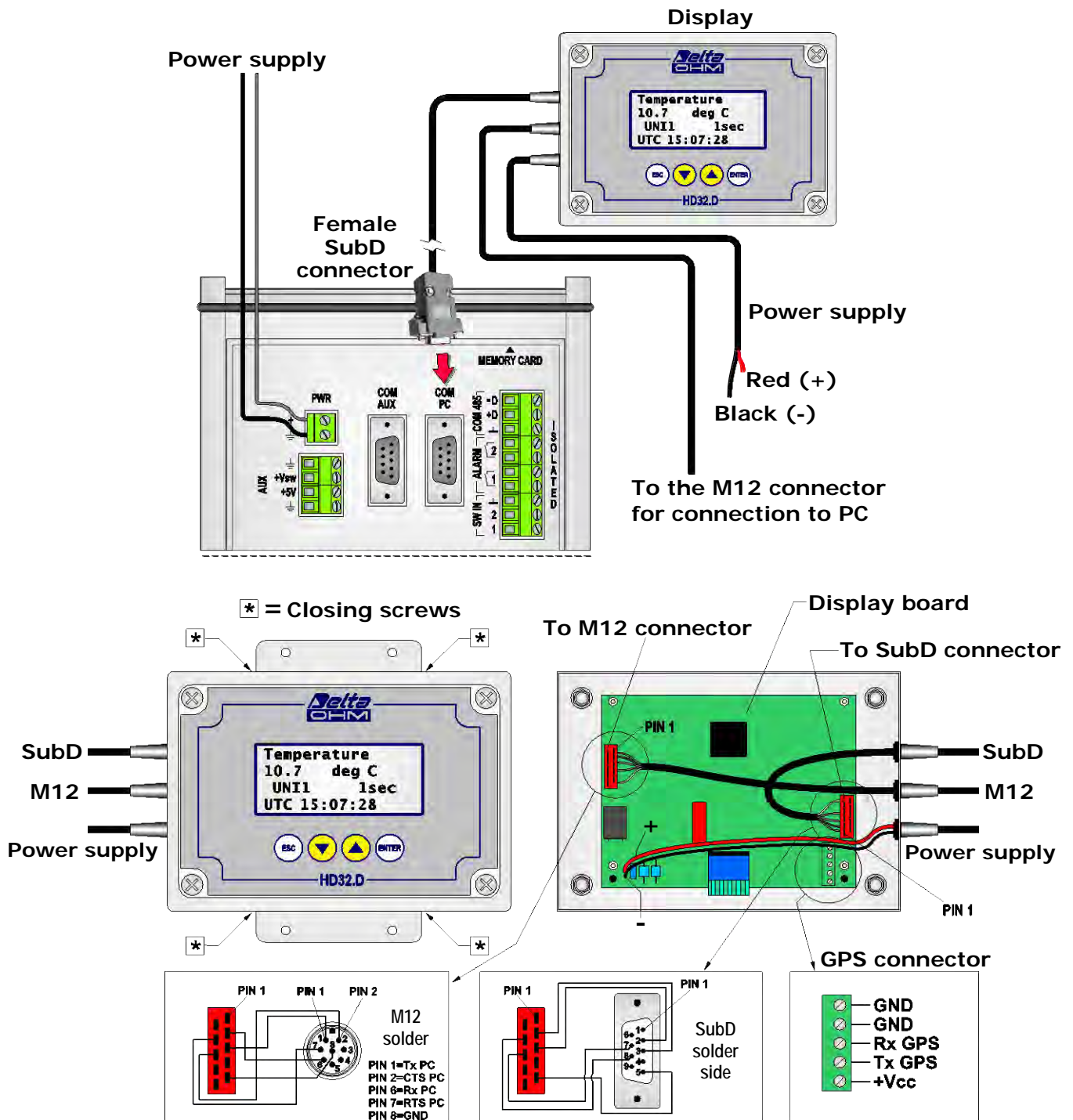

Once connected and powered, the display shows the startup screen for selecting the Baud Rate. Using the arrow keys, select:

- **115200** for the basic data logger model;
- **38400** for the data logger model with Radio Modem option.

CONNECT @ BAUD
115200
ENTER = accept
UP/DOWN = change



Press the ENTER key.

CONNECT @ BAUD
115200
ENTER = accept
UP/DOWN = change

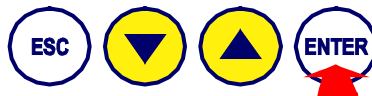

Note: If during the visualization of the startup screen for setting the baud rate no keys are pressed for 30 seconds, the display will automatically connect to the data logger (as if the ENTER key was pressed).

After a few moments, needed by the display to read the general information of the data logger, the values acquired by the data logger will be shown.

Temperature
10.7 deg C
UNI1 1sec
UTC 15:07:28

For each measurement is displayed:

- the name of the parameter measured;
- the value of the measure and the unit of measurement;
- the data logger input the sensor is connected to (see terminal board on page 9);
- the acquisition interval (*Scan Period*);
- the current UTC time in the data logger.

The various measures automatically follow one another on the display. To stop automatic scrolling, press an arrow key. The measures can be scrolled manually using the arrow keys. To reactivate the automatic scrolling, press the ENTER key.

If instead of the measured value, the message "WAITING MEASURE" appears, it means that the display is waiting for the next instant of acquisition in order to display the updated measuring values.

The appearance of the indication "DATA OBSOLETE" instead of UTC indicates that the displayed value is not the current value but the value acquired in a previous instant (the information assumes significance especially if the acquisition interval is long).

The display is backlit. The backlight turns off if no keys are pressed for 1 minute. To reactivate, simply press any key.

14.1 DISPLAY FUNCTIONS

The display has the following functions:

- Connection at 115200 baud
- Connection at 38400 baud
- Time Zone setting
- Display switch off
- Display reset
- Display of measured data
- Time synchronization

To access the list of the available functions, press the ESC key during the display of the measured values.



Temperature
10.7 deg C
UNI1 1sec
UTC 15:07:28

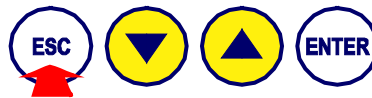

Use the arrow keys to select the desired function.

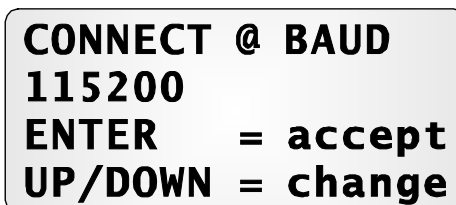

CONNECT @ BAUD
115200
ENTER = accept
UP/DOWN = change

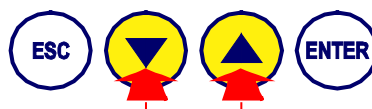

Then press the ENTER key to activate the selected function.

The details of the various functions are as follows.

➤ CONNECTION AT 115200 BAUD

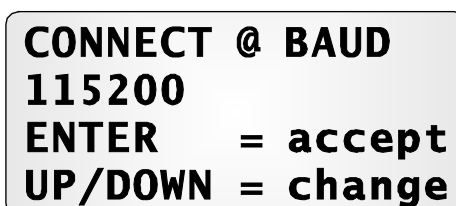

CONNECT @ BAUD
115200
ENTER = accept
UP/DOWN = change

The "CONNECT @ BAUD 115200" allows you to repeat the reading of the information of the basic model of the data logger. It is a "service" function for the technical service.

➤ **CONNECTION AT 38400 BAUD**

**CONNECT @ BAUD
38400
ENTER = accept
UP/DOWN = change**

The "CONNECT @ BAUD 38400" allows to repeat the reading of the information of the data logger model with Radio Modem option. It is a "service" function for the technical service.

➤ **TIME ZONE SETTING**

**SELECT UTC OFFS
ENTER = accept
UP/DOWN = change**

The "SELECT UTC OFFS" allows you to change the time zone set in the data logger. Press ENTER to activate the function, the currently set time zone of the data logger is displayed.

**SELECT UTC OFFS
+01.00
ENTER = accept
UP/DOWN = change**

Make sure that the set time zone corresponds to the place of installation of the data logger. If necessary, change the time zone with the arrow keys and press ENTER to confirm.

➤ **DISPLAY SWITCH OFF**

**SYSTEM SHUTDOWN?
ENTER = accept
UP/DOWN = change**

The "SYSTEM SHUTDOWN" function turns off the display. The feature is especially useful in systems that are not powered from the mains, where it is important to limit the energy consumption of the system. To switch on the display press ENTER.

➤ **DISPLAY RESET**

**SYSTEM RESET?(!)
ENTER = accept
UP/DOWN = change**

The "SYSTEM RESET" function resets the display. After reset, the display starts from the startup screen for the selection of the Baud Rate.

➤ **DISPLAY OF MEASURED DATA**

**GO DATA DISPLAY
AT SELECTED BAUD
ENTER = accept
UP/DOWN = change**

The function "GO DATA DISPLAY AT SELECTED BAUD" allows to return to the display of measuring values acquired by the data logger.

➤ **TIME SYNCHRONIZATION**

**GO GPS SYNC

ENTER = accept
UP/DOWN = change**

If the display is equipped with the GPS option (**HD32.35D.GPS** and **HD23.36.GPS**), the data logger clock is synchronized every day automatically using the information received from the GPS system.

The "GO GPS SYNC" function allows you to manually start the clock synchronization, without waiting for the automatic synchronization. Press the ENTER key, then wait for the synchronization to be completed.

14.2 PC-DATA LOGGER CONNECTION IN PRESENCE OF THE DISPLAY

To connect the PC to the data logger is not necessary to disconnect the display from the **COM PC** serial port to connect your PC. Simply connect the PC to the second serial port of the display (cable with 9-pin male SubD connector), provided for connection to PC via "null modem" cable **9CPRS232** (for RS232) or **C205** cable (for USB connection).

When the PC starts a communication session, the display acts as a "bridge" between PC and data logger. **During communication, instead of the measured values appears the message:**

**BYPASS MODE
ACTIVATED**

The display remains in this state until the end of the communication session between the PC and data logger. Once the communication session is concluded, after a few seconds the display returns to normal operation.

The PC-logger connection through the display is only possible if the display is turned on (no need to press ENTER to activate the connection).

15 LITHIUM BATTERY REPLACEMENT

The data logger has an internal lithium battery that allows operation of the clock of the instrument even without external power.

When the data logger is powered externally, the internal battery is not used, in order to preserve the charge and prolong its life.

If the internal battery is discharged, the logger clock continues to operate normally until the external power supply is present, if that fails, the current date and time are lost and need to be reprogrammed.

Should it be necessary to replace the internal battery, proceed as follows:

1. Disconnect the external power supply of the data logger.
2. Unscrew the four screws that secure the two side covers of the housing, then remove the two lids.

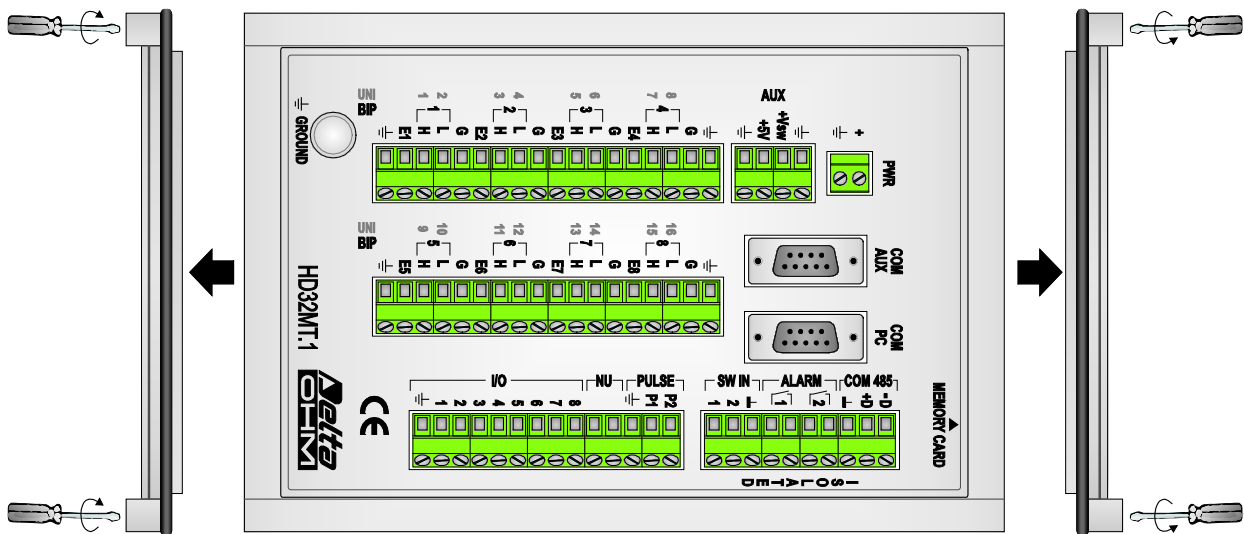

3. The battery is located on the underside of the board, on the side of the ground knob. Push the circuit board to the bottom of the housing, pushing close to the two connectors on the sides, so as to remove the card from the top panel.

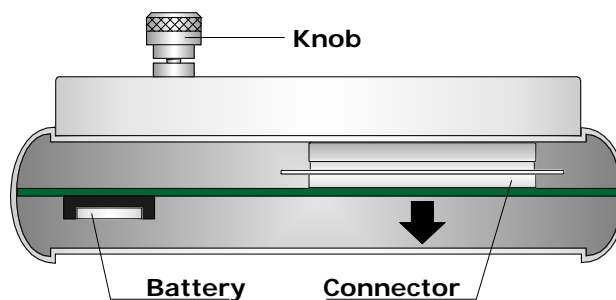

4. Pull the board out and replace the battery with another of the same type (**CR2032**), observing the correct polarity (the positive of the battery is facing out of the battery holder).
5. Reinsert the board and connect it to the top panel, making sure that both connectors are correctly aligned. Replace the two side covers and secure with the four screws.

16 MOUNTING THE DATA LOGGER

The data logger can be attached to a panel by means of two rear supports. The figure below shows the size in mm for fixing.

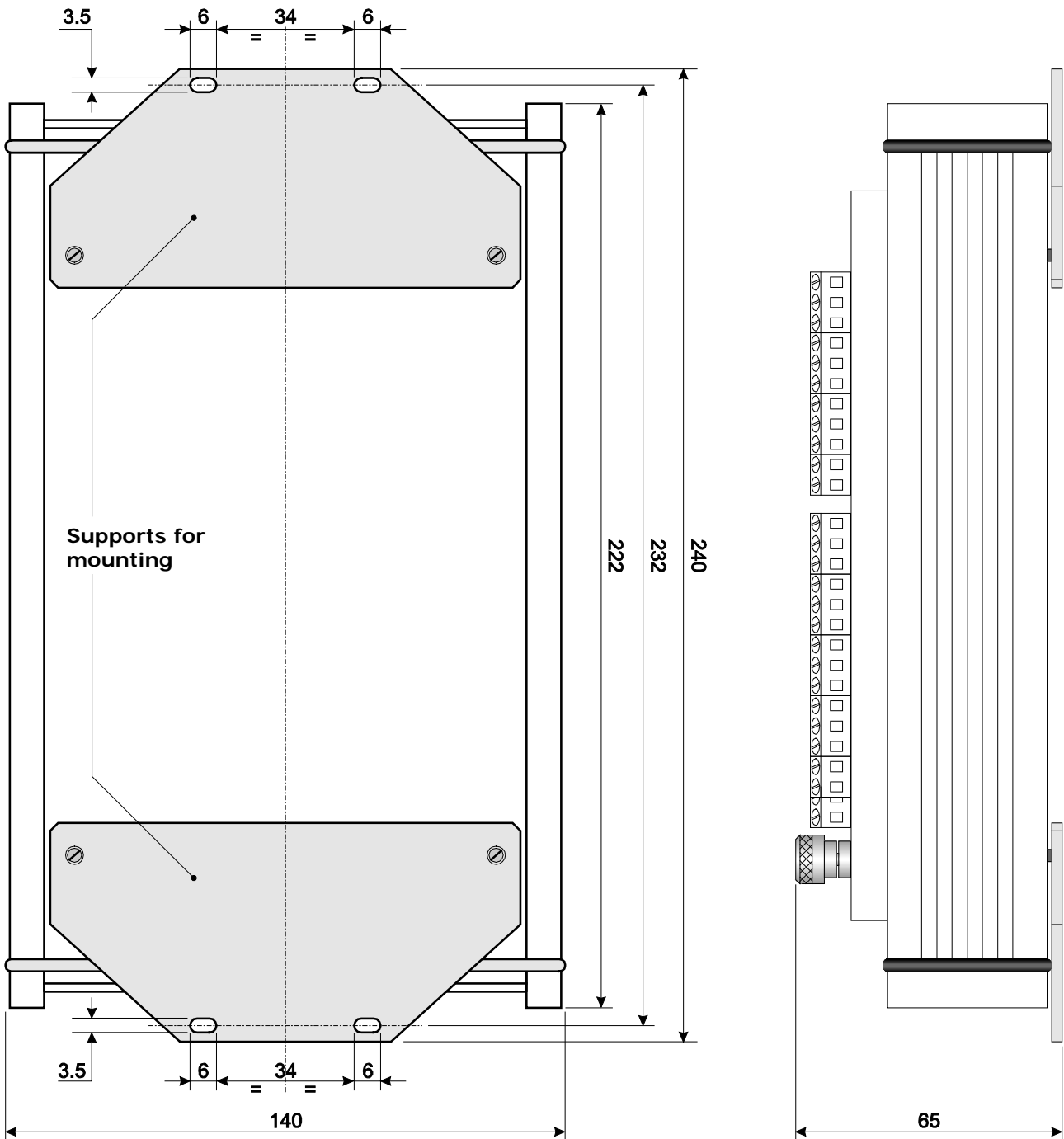

17 INSTRUMENT STORAGE

Instrument storage conditions:

- Temperature: -25...+65 °C.
- Humidity: less than 90% RH, without condensation.
- During storage avoid locations where:
 - humidity is high;
 - the instrument may be exposed to direct sunlight;
 - the instrument may be exposed to a high temperature source;
 - the instrument may be exposed to strong vibrations;
 - the instrument may be exposed to steam, salt or any corrosive gas.

18 SAFETY INSTRUCTIONS

General safety instructions

This instrument has been manufactured and tested in compliance with safety standards EN61010-1 relating to electronic measuring instruments and left the factory in perfect technical condition of safety.

The regular functioning and operational safety of the instrument can only be guaranteed if all normal safety measures are observed as well as those specific described in this operating manual.

The regular functioning and operational safety of the instrument can only be guaranteed under the climatic conditions specified in the manual.

Do not use the instrument in places where they are present:

Quick environment temperature changes that could cause condensation.
Corrosive or inflammable gases.
Direct vibrations or shocks.
High intensity electromagnetic fields or static electricity.

If the instrument was transported from a cold to a warm place or vice versa, the formation of condensation can disturb its operation. In this case wait for the temperature of the instrument to reach room temperature before putting it into service.

User obligations

The instrument user must ensure that the following standards and guidelines for treatment of hazardous materials are followed:

CEE directives on job safety
National laws on job safety
Accident prevention regulations

19 ORDER CODES

HD32MT.1 Data logger supplied with: **HD32MTLogger** software downloadable from Delta OHM website (for programming, data downloading, monitoring and data processing on a PC), SD card and operating manual.

The probes, the cables, the optional external modules and the display must be ordered separately. The radio modem option should be requested when ordering.

ACCESSORIES

HD32MT.ALM Sensor that signals the opening of the housing door.

9CPRS232 Null modem cable with 9-pin Sub-D female connector on both sides for connection to the PC RS232C. Cable length 2 m.

C.205 Connection cable with USB connector on PC side and sub-D 9-pole female connector on instrument side. The cable has a built-in RS232/USB converter and connects the data logger directly to the USB port of the PC.

C.205M Connection cable with USB connector on PC side and sub-D 9-pole male connector on Radio Modem side. The cable has a built-in RS232/USB converter and connects the Radio Modem directly to the USB port of the PC.

CP25 Serial connection cable with USB connector on the PC side and 8-pole M12 female connector on the outdoor housing side. The cable has a built-in USB/RS232 converter and connects the HD32.35, HD32.35FP, HD32.36 and HD32.36FP outdoor housings to the PC USB port.

HD32.35 HD32MT.1 data logger integrated in an **AISI 304 stainless steel outdoor housing**. Screen to protect the housing from solar radiation. Powder-coated white. Double locking one of which is a key. Dimensions 450 x 300 x 210 mm. Degree of protection IP66. Supplied with accessories for attachment to the pole diameter 36 ÷ 52 mm. **Provided for 100 ÷ 240 Vac mains power supply**, includes: HD32MT.1 data logger, AC/DC power supply unit with integrated battery charger, 12V rechargeable backup battery, surge protectors, disconnectors, terminal block for power supply distribution and connectors for connecting the external sensors. **Wired and tested.**

HD32.35FP HD32MT.1 data logger **integrated in an AISI 304 stainless steel outdoor housing**. Screen to protect the housing from solar radiation. Powder-coated white. Double locking one of which is a key. Dimensions 450 x 300 x 210 mm. Degree of protection IP66. Supplied with accessories for attachment to the pole diameter 36 ÷ 52 mm. **Provided for power supply from solar panel**, includes: HD32MT.1 data logger, solar charge controller, terminal block for power supply distribution and connectors for connecting the external sensors. **Wired and tested.**

HD32.36 HD32MT.1 data logger integrated in a **fiberglass-reinforced hot-pressed polyester outdoor housing**. Screen to protect the housing from solar radiation, powder-coated anodized aluminum. White. Key lock. Dimensions 415 x 310 x 170 mm. Degree of protection IP66. Supplied with accessories for attachment to the stainless steel pole diameter 36 ÷ 52 mm. **Provided for 100 ÷ 240Vac mains power supply**, includes: HD32MT.1 data logger, AC/DC power supply unit with integrated battery charger, 12V rechargeable backup battery, surge protectors, disconnectors, terminal block for power supply distribution and connectors for connecting the external sensors. **Wired and tested.**

- HD32.36FP** HD32MT.1 data logger integrated in a **fiberglass-reinforced hot-pressed polyester outdoor housing**. Screen to protect the housing from solar radiation, powder-coated anodized aluminum. White. Key lock. Dimensions 415 x 310 x 170 mm. Degree of protection IP66. Supplied with accessories for attachment to the stainless steel pole diameter 36 ÷ 52 mm. **Provided for power supply from solar panel**, includes: HD32MT.1 data logger, solar charge controller, terminal block for power supply distribution and connectors for connecting the external sensors. **Wired and tested.**
- HD32.D** LCD viewer designed for being fixed on outdoor housings HD32.35, HD32.35FP, HD32.36 and HD32.36FP.
- HD32.D.GPS** LCD viewer designed for being fixed on outdoor housings HD32.35, HD32.35FP, HD32.36 and HD32.36FP. With GPS module for automatical time synchronization of the data logger.
- HD2005.20** Tripod with adjustable legs for installing environmental sensors. Material: anodized aluminum. Max. height 225 cm. It can be fixed on a flat base with screws or to the ground with pegs.
- HD2005.20.1** Tripod with adjustable legs for installing environmental sensors. Material: anodized aluminum. Max. height 335 cm. It can be fixed on a flat base with screws or to the ground with pegs.

Delta OHM has a wide range of sensors for measuring environmental physical quantities. Please visit www.deltaohm.com or contact Delta OHM directly.

DELTA OHM metrology laboratories LAT N° 124 are ISO/IEC 17025 accredited by ACCREDIA for Temperature, Humidity, Pressure, Photometry / Radiometry, Acoustics and Air Velocity. They can supply calibration certificates for the accredited quantities.

20 OUTDOOR HOUSINGS DESCRIPTION

HD32.35 OUTDOOR HOUSING

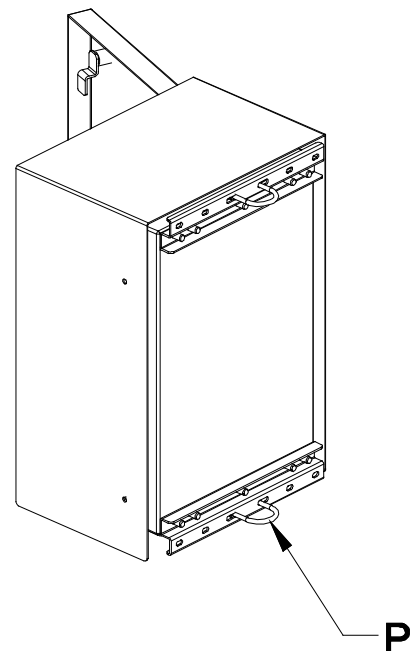
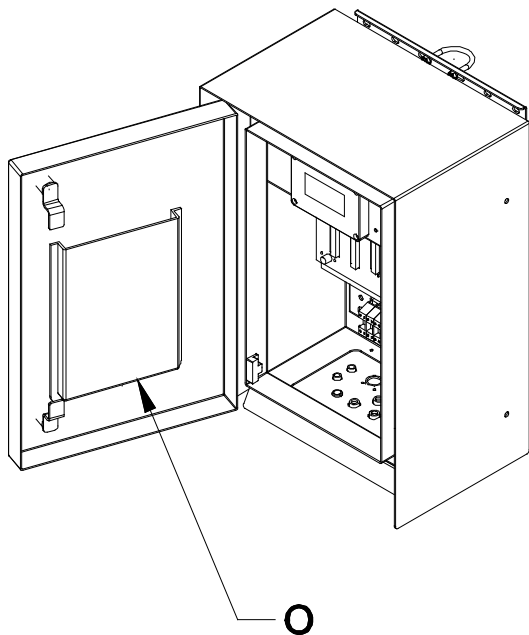
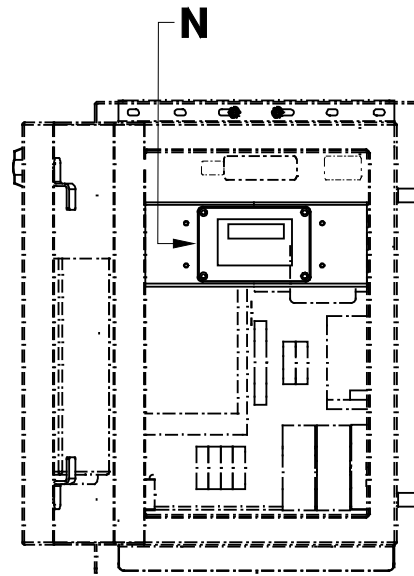
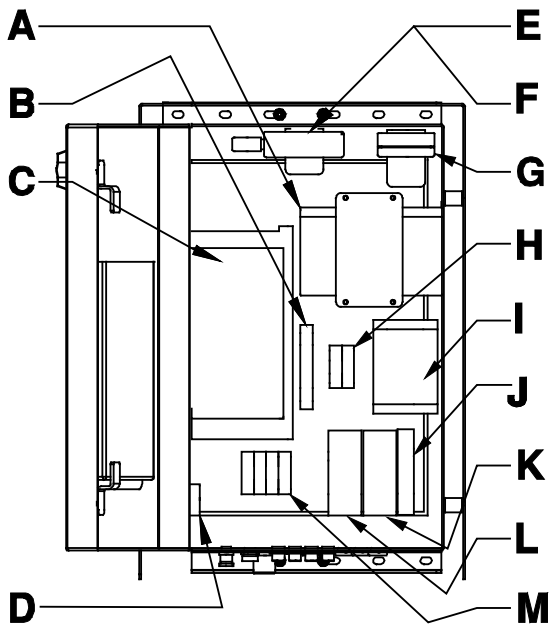

A = Backup battery
B = RS485 surge protector
C = HD32MT.1 Data Logger
D = Door opening alarm (**optional**)
E = GSM/GPRS module (**optional**)
F = Radio Modem (**optional**)
G = Barometric transmitter (**optional**)
H = Terminal block

I = Power supply unit
J = Fuse
K = Disconnecter
L = Power supply surge protector
M = Terminal block
N = Display (**optional**)
O = Documentation holder
P = Hook for attachment to the mast

HD32.35FP OUTDOOR HOUSING

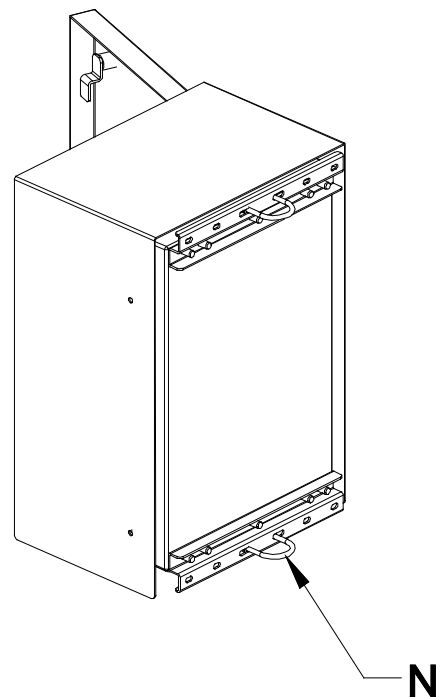
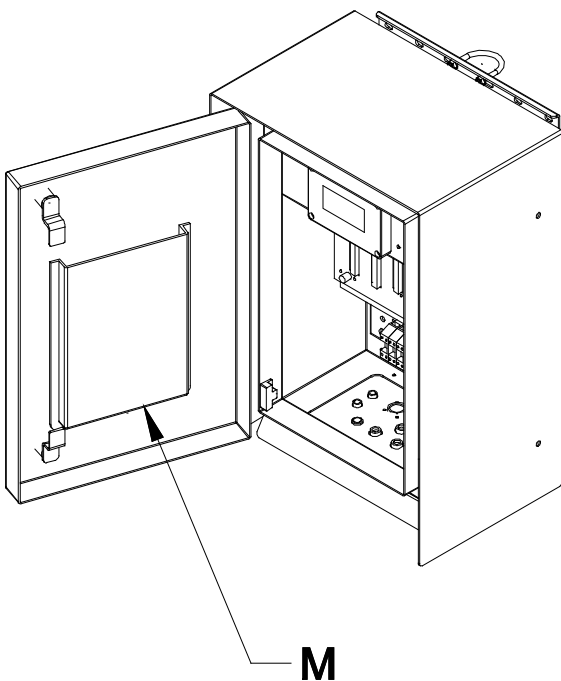
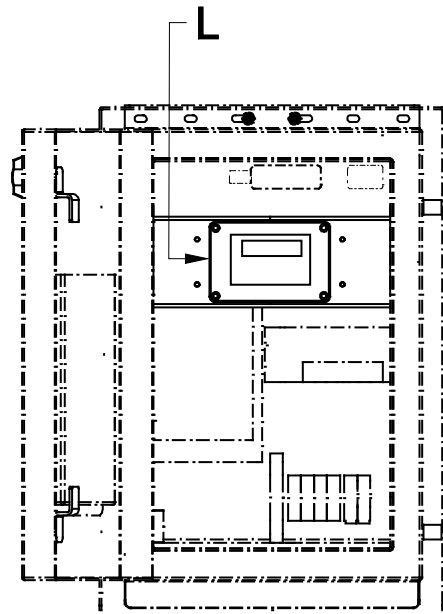
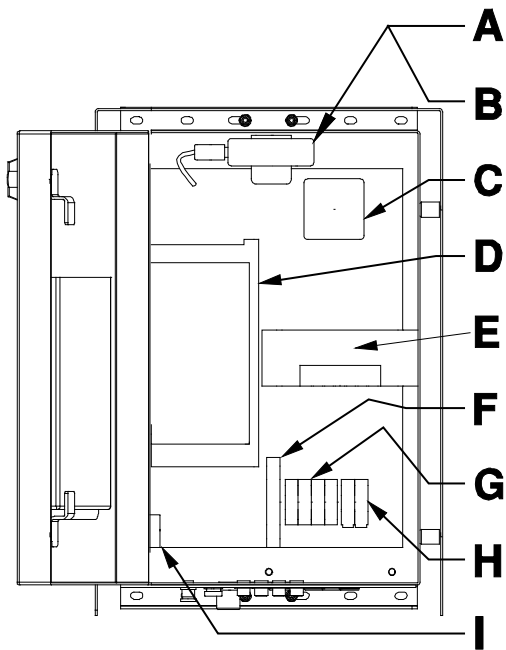

- A = GSM/GPRS module (optional)
- B = Radio Modem (optional)
- C = Barometric transmitter (optional)
- D = HD32MT.1 Data Logger
- E = Charge controller
- F = RS485 surge protector

- G = Terminal block
- H = Terminal block
- I = Door opening alarm (optional)
- L = Display (optional)
- M = Documentation holder
- N = Hook for attachment to the mast

HD32.36 OUTDOOR HOUSING

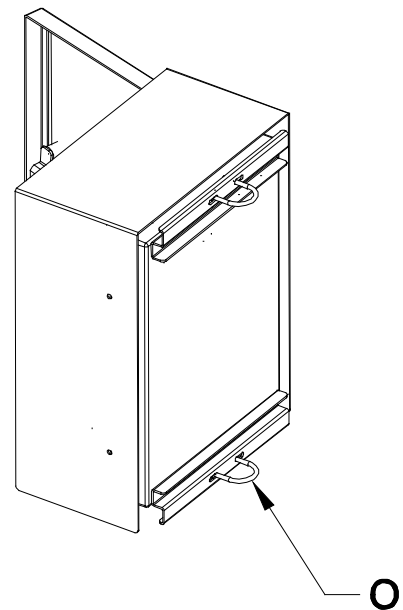
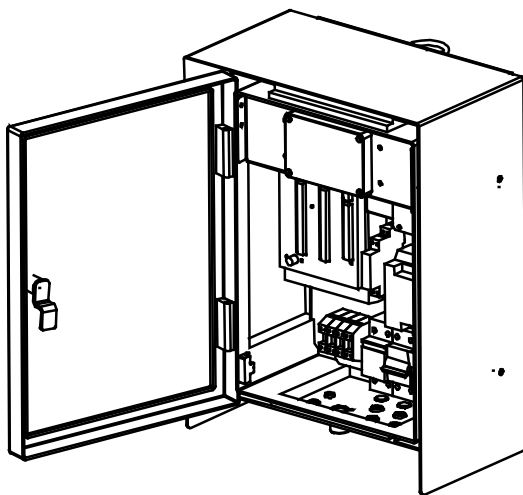
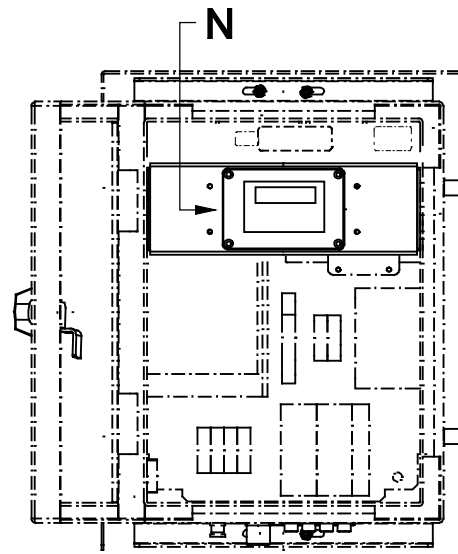
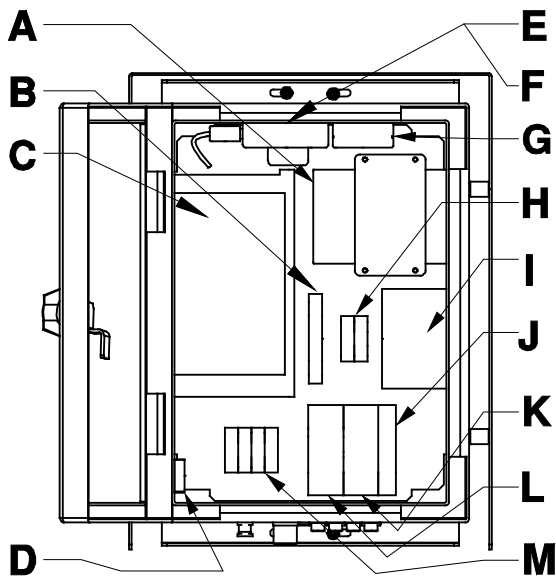

A = Backup battery
B = RS485 surge protector
C = HD32MT.1 Data Logger
D = Door opening alarm (**optional**)
E = GSM/GPRS module (**optional**)
F = Radio Modem (**optional**)
G = Barometric transmitter (**optional**)
H = Terminal block

I = Power supply unit
J = Fuse
K = Disconnecter
L = Power supply surge protector
M = Terminal block
N = Display (**optional**)
O = Hook for attachment to the mast

HD32.36FP OUTDOOR HOUSING

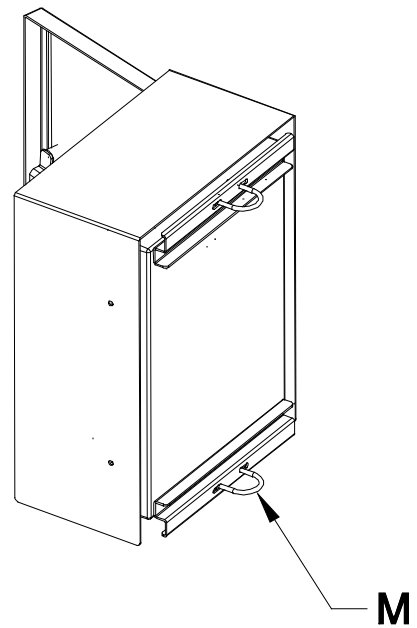
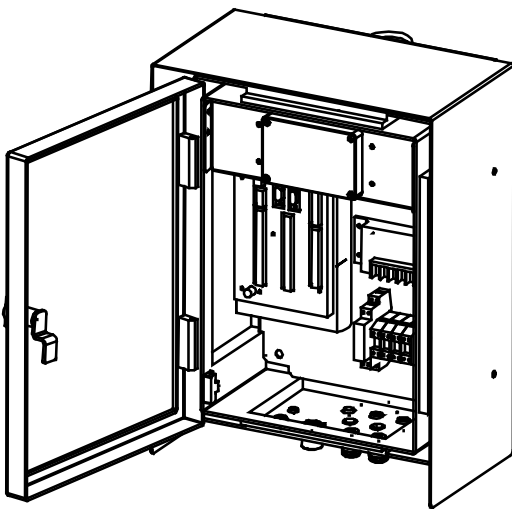
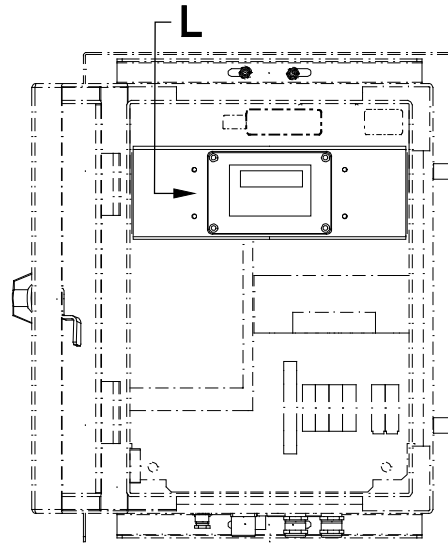
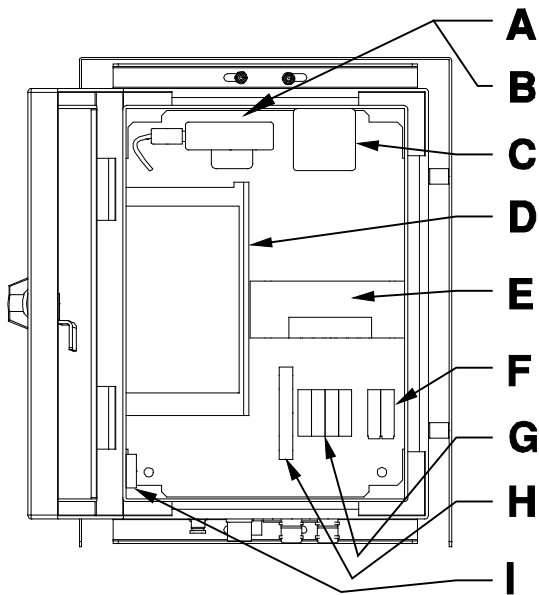

A = GSM/GPRS module (**optional**)
B = Radio Modem (**optional**)
C = Barometric transmitter (**optional**)
D = HD32MT.1 Data Logger
E = Charge controller
F = Terminal block

G = Terminal block
H = RS485 surge protector
I = Door opening alarm (**optional**)
L = Display (**optional**)
M = Hook for attachment to the mast

INSTALLATION OF HD32.3X OUTDOOR HOUSING

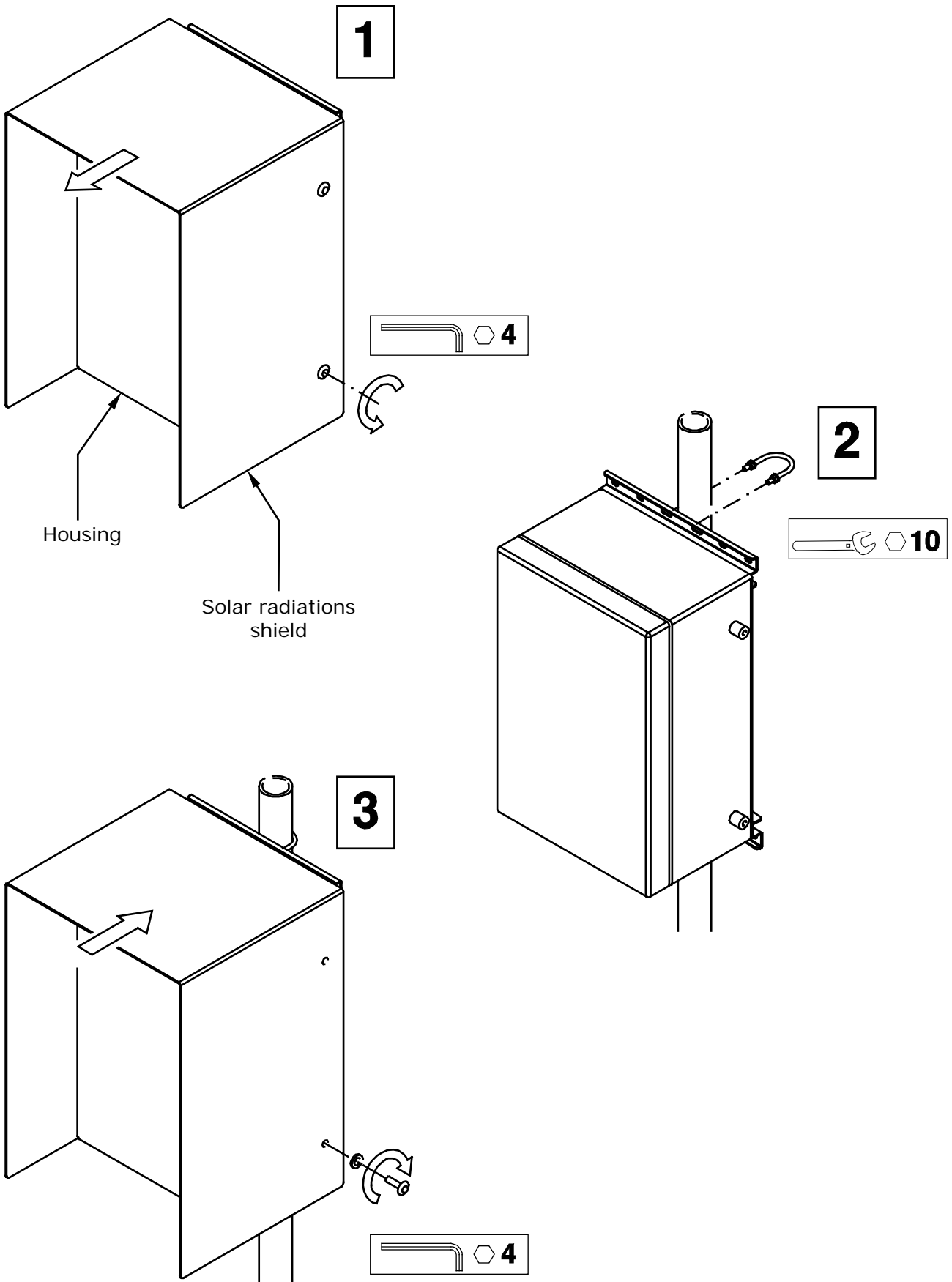

APPENDIX A – ERROR CODES

Error codes	Description
Err 001	Program error or Modbus function code is not valid
Err 002	Program error or Modbus address is not valid
Err 003	Program error or Modbus value is not valid
Err 004	Program error or Modbus sensor malfunction
Err 005	Program error or upload stopped
Err 006	Program error or dumping stopped or Modbus sensor busy
Err 007	Program error or SD activity stopped
Err 008	Program error
Err 009	Program error
Err 010	Program error or sending SMS stopped
Err 011	Program error
Err 012	Program error or Scan Period error
Err 013	Program error or flash memory page counter error
Err 014	Program error or insufficient remaining time for the measurement
Err 015	Program error
Err 016	Program error
Err 017	Program error
Err 018	Ultrasonic anemometer (RS485) measurement error
Err 019	A/D conversion error
Err 020	Counting error
Err 021	DAC error
Err 022	No measurements done
Err 023	Program error
Err 025	RS485 sensors measurements not received
Err 026	Error writing flash memory or Modbus CRC error
Err 027	RS485 sensor header not correct
Err 028	Non-numeric ASCII character (for RS485 anemometers)
Err 029	Program error or number of characters less than the minimum (Modbus sensors)
Err 031	Program error
Err 034	ADC overflow
Err 035	Open circuit (thermocouple)
Err 036	Program error
Err 038	Program error
Err 039	RAM memory corrupted
Err 041	Resistive or thermocouple measurement out of range or non-numeric Modbus value
Err 042	ADC oscillator error
Err 043	Program error
Err 044	Clock circuit error
Err 045	Single quantity of ultrasonic anemometer (RS485) not received
Err 046	ADC (analog inputs) error
Err 047	IO (digital inputs) error
Err 048	RAM clock error
Err 049	Low battery level
Err 050	Program error
Err 051	Register error on power up
Err 057	Program error
Err 090	Flash memory corrupted
Err 091	Flash memory corrupted
Err 092	Flash memory corrupted
Err 095	Internal error
Err 096	Flash memory corrupted
Err 097	RAM memory corrupted
Err 099	Scan Period error

NOTES

**DICHIARAZIONE DI CONFORMITÀ UE
EU DECLARATION OF CONFORMITY****Delta Ohm S.r.L. a socio unico – Via Marconi 5 – 35030 Caselle di Selvazzano – Padova – ITALY**Documento Nr. / Mese.Anno: **5028 / 07.2019**
Document-No. / Month. Year :

Si dichiara con la presente, in qualità di produttore e sotto la propria responsabilità esclusiva, che i seguenti prodotti sono conformi ai requisiti di protezione definiti nelle direttive del Consiglio Europeo:

We declare as manufacturer herewith under our sole responsibility that the following products are in compliance with the protection requirements defined in the European Council directives:

Codice prodotto: **HD32MT.1**
Product identifier :Descrizione prodotto: **Datalogger programmabile**
Product description : **Programmable Data Logger**I prodotti sono conformi alle seguenti Direttive Europee:
The products conform to following European Directives:

Direttive / Directives	
2014/30/EU	Direttiva EMC / <i>EMC Directive</i>
2014/35/EU	Direttiva bassa tensione / <i>Low Voltage Directive</i>
2011/65/EU - 2015/863/EU	RoHS / <i>RoHS</i>

Norme armonizzate applicate o riferimento a specifiche tecniche:
Applied harmonized standards or mentioned technical specifications:

Norme armonizzate / <i>Harmonized standards</i>	
EN 61010-1:2010	Requisiti di sicurezza elettrica / <i>Electrical safety requirements</i>
EN 61326-1:2013	Requisiti EMC / <i>EMC requirements</i>
EN 50581:2012	RoHS / <i>RoHS</i>

Il produttore è responsabile per la dichiarazione rilasciata da:
The manufacturer is responsible for the declaration released by:

Johannes Overhues

Amministratore delegato
Chief Executive Officer

Caselle di Selvazzano, 19/07/2019

Questa dichiarazione certifica l'accordo con la legislazione armonizzata menzionata, non costituisce tuttavia garanzia delle caratteristiche.

This declaration certifies the agreement with the harmonization legislation mentioned, contained however no warranty of characteristics.

WARRANTY

Delta OHM is required to respond to the "factory warranty" only in those cases provided by Legislative Decree 6 September 2005 - n. 206. Each instrument is sold after rigorous inspections; if any manufacturing defect is found, it is necessary to contact the distributor where the instrument was purchased from. During the warranty period (24 months from the date of invoice) any manufacturing defects found will be repaired free of charge. Misuse, wear, neglect, lack or inefficient maintenance as well as theft and damage during transport are excluded. Warranty does not apply if changes, tampering or unauthorized repairs are made on the product. Solutions, probes, electrodes and microphones are not guaranteed as the improper use, even for a few minutes, may cause irreparable damages.

Delta OHM repairs the products that show defects of construction in accordance with the terms and conditions of warranty included in the manual of the product. For any dispute, the competent court is the Court of Padua. The Italian law and the "Convention on Contracts for the International Sales of Goods" apply.

TECHNICAL INFORMATION

The quality level of our instruments is the result of the continuous product development. This may lead to differences between the information reported in the manual and the instrument you have purchased. In case of discrepancies and/or inconsistencies, please write to sales@deltaohm.com. Delta OHM reserves the right to change technical specifications and dimensions to fit the product requirements without prior notice.

DISPOSAL INFORMATION

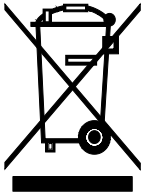

Electrical and electronic equipment marked with specific symbol in compliance with 2012/19/EU Directive must be disposed of separately from household waste. European users can hand them over to the dealer or to the manufacturer when purchasing a new electrical and electronic equipment, or to a WEEE collection point designated by local authorities. Illegal disposal is punished by law.

Disposing of electrical and electronic equipment separately from normal waste helps to preserve natural resources and allows materials to be recycled in an environmentally friendly way without risks to human health.

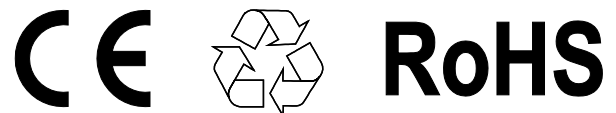

V2.0
03/2022