



KERN & Sohn GmbH

Ziegelei 1
D-72336 Balingen
Courriel : info@kern-sohn.com

Téléphone : +49-[0]7433-9933-0
Télécopie : +49-[0]7433-9933-149
Web: www.kern-sohn.com

Instruction d'installation du support vertical

KERN EOB-A01B-A02B

Version 1.1
12/2016
F

EOB-A01B-A02B-IA-f-1611



KERN EOB-A01B-A02B

Version 1.1 12/2016

Instruction d'installation du support vertical

Sommaire

1	Données techniques	2
2	Éléments livrés	3
3	Aperçu	5



EOB-A01B







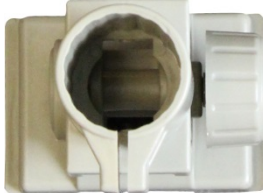

uniquement les plates-formes de 304 x 315 mm

1 Données techniques







KERN	EOB-A01B	EOB-A02B
Hauteur du support	48 cm	100 cm

2 Éléments livrés

EOB-A01B:

 <p>Support</p>	 <p>Anneau de fixation du support</p>
 <p>Pied de support</p>	 <p>1 vis</p>
 <p>Cylindre en plastique</p>	 <p>1 vis avec écrou</p>
 <p>4 vis</p>	 <p>3 guides-fils et 3 vis</p>
 <p>Patin en caoutchouc</p>	 <p>x 3</p>

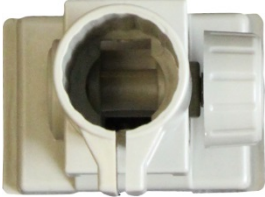
EOB-A02B

 <p>Support</p>	 <p>Pied de support</p>
 <p>Cylindre en plastique</p>	 <p>3 pieds réglables</p>
 <p>Anneau de fixation du support</p>	 <p>3 vis</p>
 <p>1 vis avec écrou</p>	

3 Aperçu

EOB-A01B:

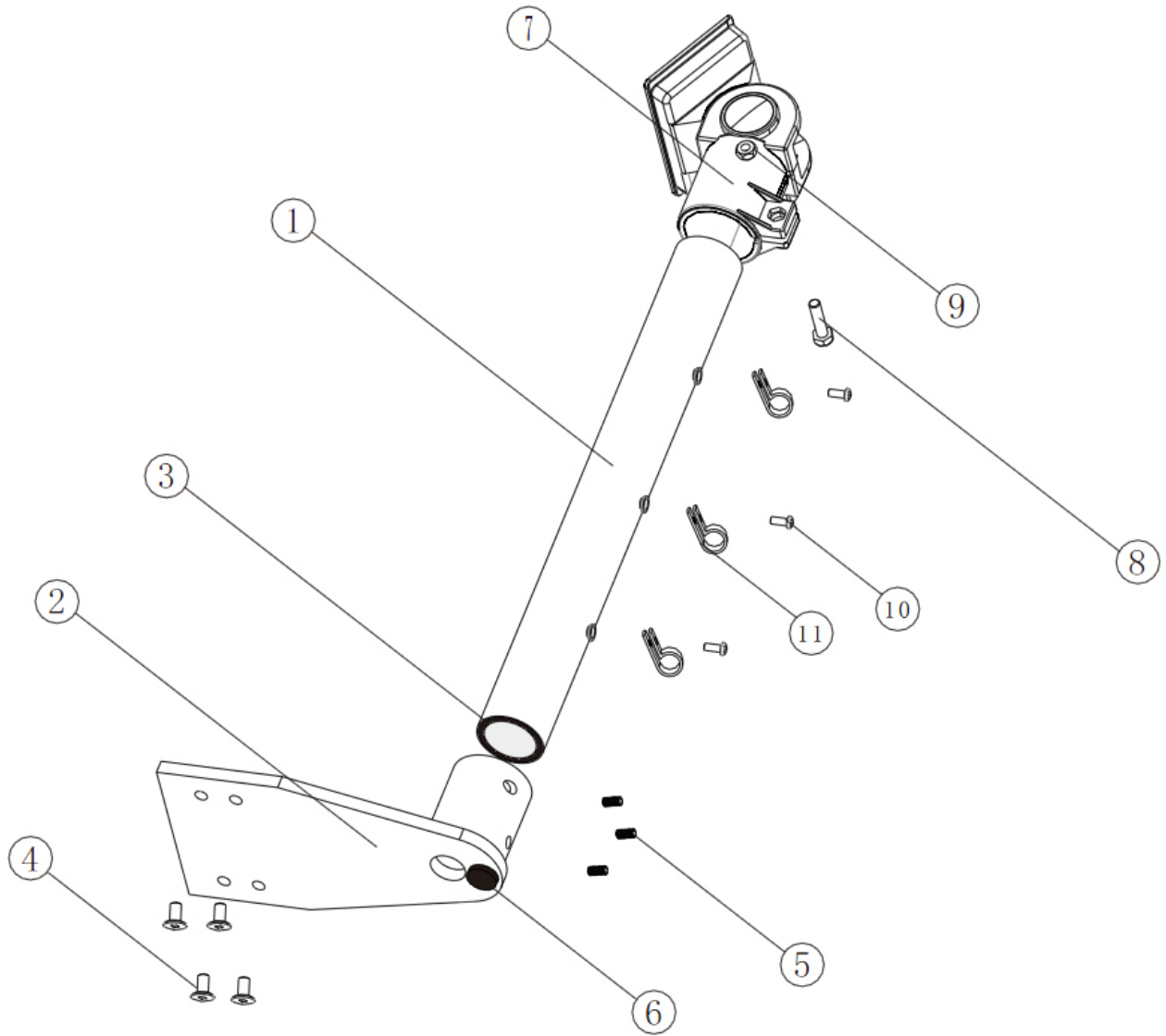

1	Support	7	Anneau de fixation du support
2	Pied de support	8	Vis
3	Cylindre en plastique	9	Vis
4	Vis	10	Vis
5	Vis	11	Gide-fil
6	Patin en caoutchouc		

EOB-A02B

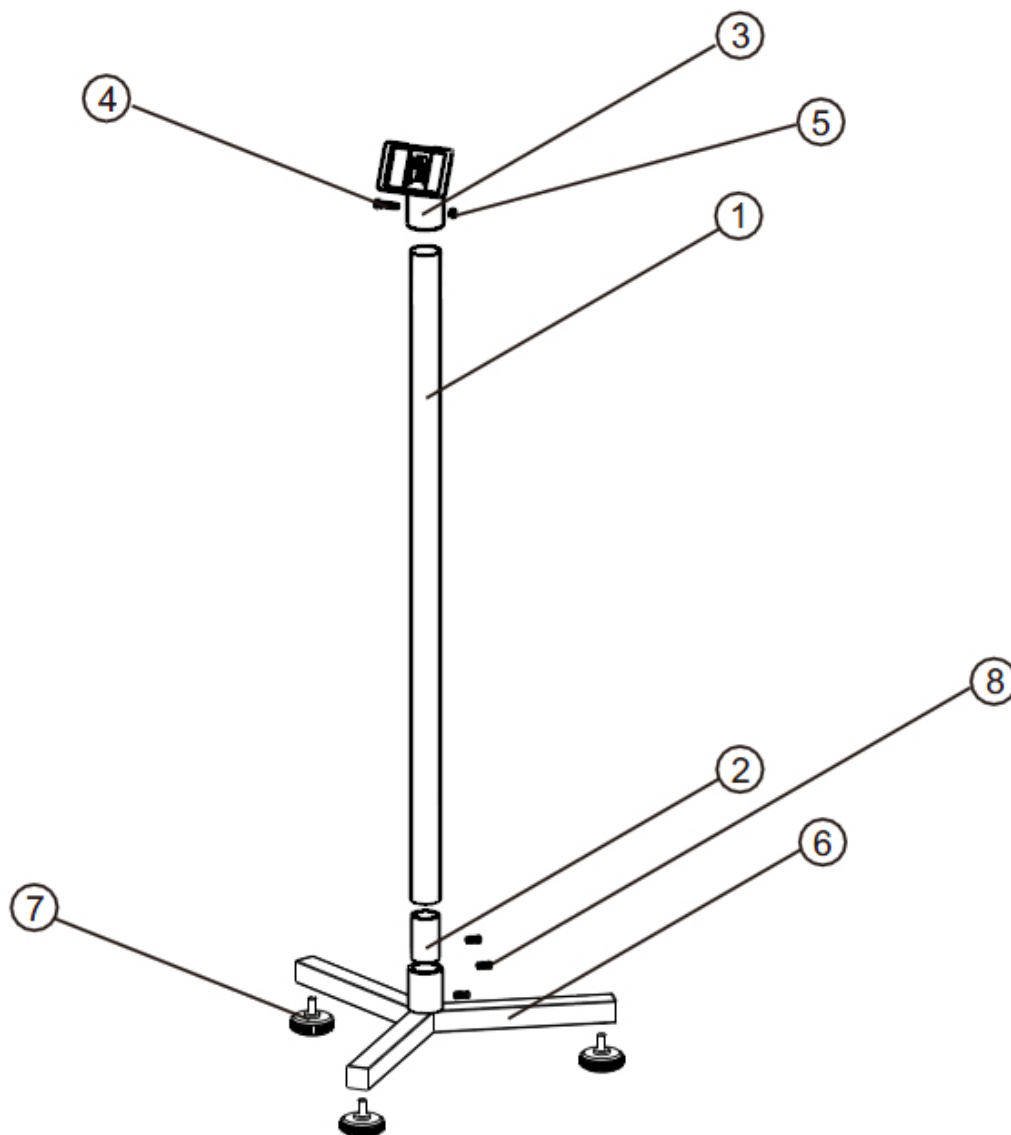

1	Support
2	Cylindre en plastique
3	Anneau de fixation du support
4	Vis
5	Écrou
6	Pied de support
7	Pieds réglable
8	Vis