

User instructions

Video microscope

KERN

OIV-6

OIV 656

Version 1.1
06/2022





KERN OIV-6

Version 1.1 06/2022

Operating instructions

Video microscope

Table of contents

1#	Before use	3#
1.1#	General notes	3#
1.2#	Notes on the electrical system.....	3#
1.3#	Storage.....	4#
1.4#	Maintenance and cleaning.....	5#
2#	Nomenclature	6#
3#	Basic data.....	8#
4#	Assembly and operation	9#
4.1#	Overview	9#
4.2#	Focus, magnification and illumination	10#
5#	Software functions.....	11#
5.1#	Control interface.....	11#
5.1.1#	Lock menu.....	12#
5.1.2#	Focus Mode	12#
5.1.3#	AF ROI (Auto Focus Region of Interest / focusing frame)	13#
5.1.4#	Exposure	13#
5.1.5#	White Balance	14#
5.1.6#	Function	14#
5.1.7#	Crosshair Tool.....	15#
5.1.8#	Photograph.....	17#
5.1.9#	Recording.....	18#
5.1.10#	Open Picture	19#
5.1.11#	Compare Pictures.....	20#
5.1.12#	Time Setting	21#
5.1.13#	Freeze	21#
5.1.14#	Save Graphics.....	22#
5.1.15#	Flip / Mirror	22#
5.1.1#	WDR.....	22#
5.1.2#	Gamma	22#
5.1.3#	FBL.....	22#
5.1.4#	Anti-screen Flicker.....	22#
5.1.5#	Black and White mode	22#
5.1.6#	Default.....	22#
5.2#	Measurement interface	23#
5.2.1#	Assist Tool.....	24#
5.2.2#	Measurement Tool	24#
5.2.4#	Custom Template.....	25#
5.2.5#	Measurement Operation.....	26#
7#	Equipment	30#
8#	Troubleshooting.....	30#
9#	Service	31#
10#	Disposal.....	31#
11#	Further information.....	31#

1 Before use

1.1 General notes

The packaging must be opened carefully to prevent any accessories inside from falling to the floor and breaking.

In general, a microscope should always be handled with great care, as it is a sensitive precision instrument. Avoiding abrupt movements during operation or transport is therefore particularly important, especially to avoid endangering the optical components.

Similarly, you should avoid dirt or fingerprints on the lens surfaces, because in most cases this reduces image clarity.

If the performance of the microscope is to be maintained, it must never be disassembled. Components such as objective lenses and other optical components should therefore be left as they are found at the beginning of operation.

1.2 Notes on the electrical system

Before connecting to a power supply network, it is important to ensure that the correct input voltage is used. The information to select the correct mains cable is located on the device, on the side of the product directly next to the connection socket. You must comply with this information. If you do not comply with these specifications, then fires or other damage to the device could occur.

Likewise, the main switch should be turned off before connecting the mains cable. This prevents an electric shock from being triggered.

If you use an extension cable, the mains cable used must be grounded.

All handling of the units that involves contact with the electrics, such as changing lamps, may only be carried out when the power supply is disconnected.

1.3 Storage

Avoid exposing the unit to direct sunlight, high or low temperatures, shocks, dust and high humidity.

The suitable temperature range is 0 - 40° C and a relative humidity of 85 % should not be exceeded.

The unit should always be on a firm, smooth and horizontal surface.

When the microscope is not being used, you should cover it with the enclosed dust protective cover.

Dust or dirt inside the optics of a microscope can in many cases cause irreversible malfunctions or damage.

The best way to store accessories which consist of optical elements, such as, for example, additional objectives, is in a dry box with desiccant.

1.4 Maintenance and cleaning

In any case, the unit must be kept clean and regularly cleaned of dust. Before wiping down the unit when wet, make sure that the power is switched off.

Glass components should preferably be wiped lightly with a lint-free cloth if contaminated.

To wipe off oil stains or fingerprints from lens surfaces, the lint-free cloth is moistened with a mixture of ether and alcohol (mixing ratio 70 / 30) and then used for cleaning.

Ether and alcohol must always be handled with care as they are highly flammable substances. It is therefore essential to keep them away from naked flames and electrical appliances that are switched on and off, and to use them only in well-ventilated rooms.

However, organic solutions of this type should not be used to clean other components of the unit. This could result in changes to the paintwork. It is sufficient to use a neutral cleaning agent for this purpose.

Other cleaning agents for the optical components include:

- Special cleaner for optical lenses
- Special optical cleaning cloths
- Bellows
- Brush

If handled correctly and checked regularly, the microscope will function smoothly for many years.

Should a repair still be necessary, contact your KERN dealer or our Technical Service.

2 Nomenclature

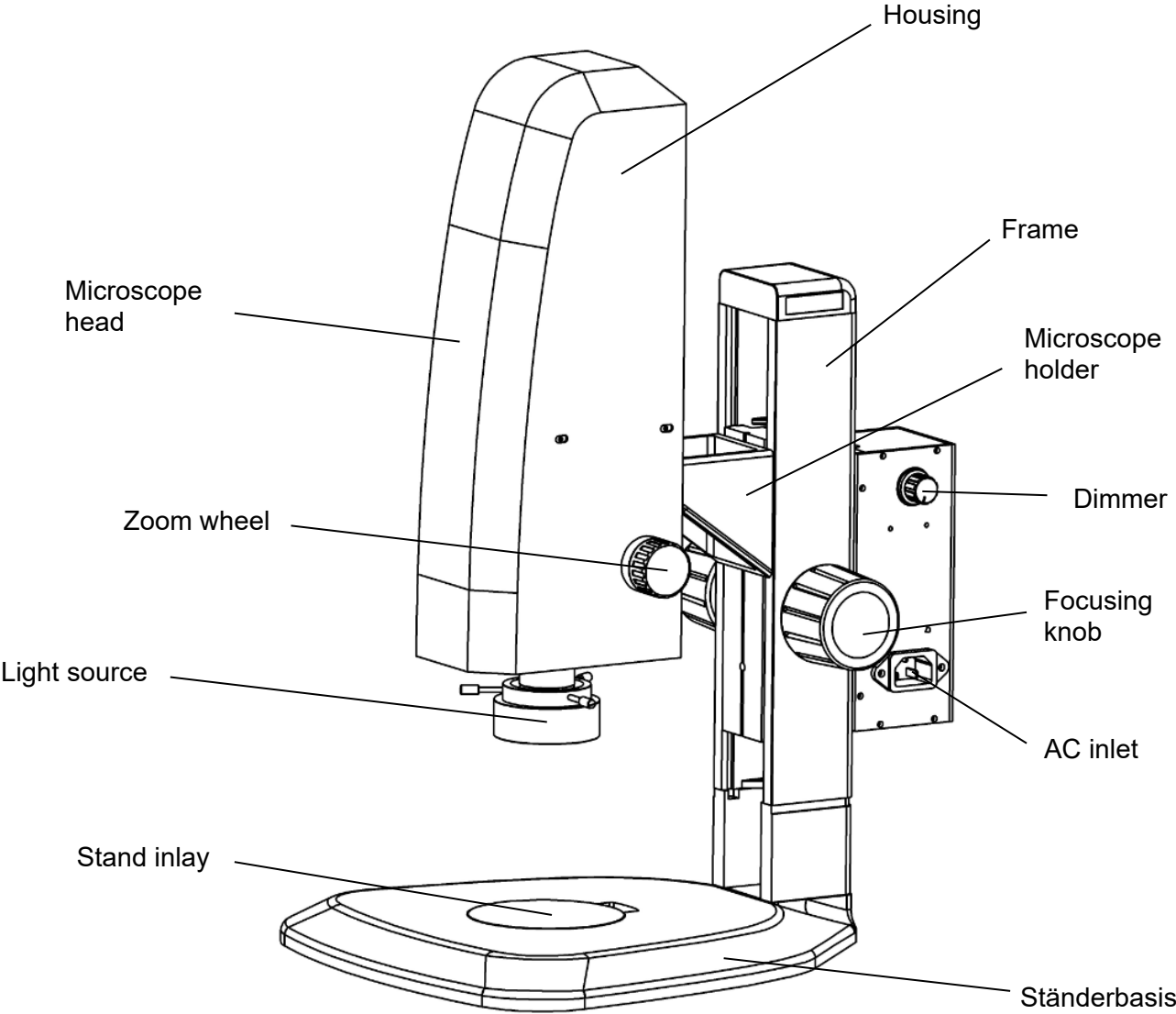

Rear

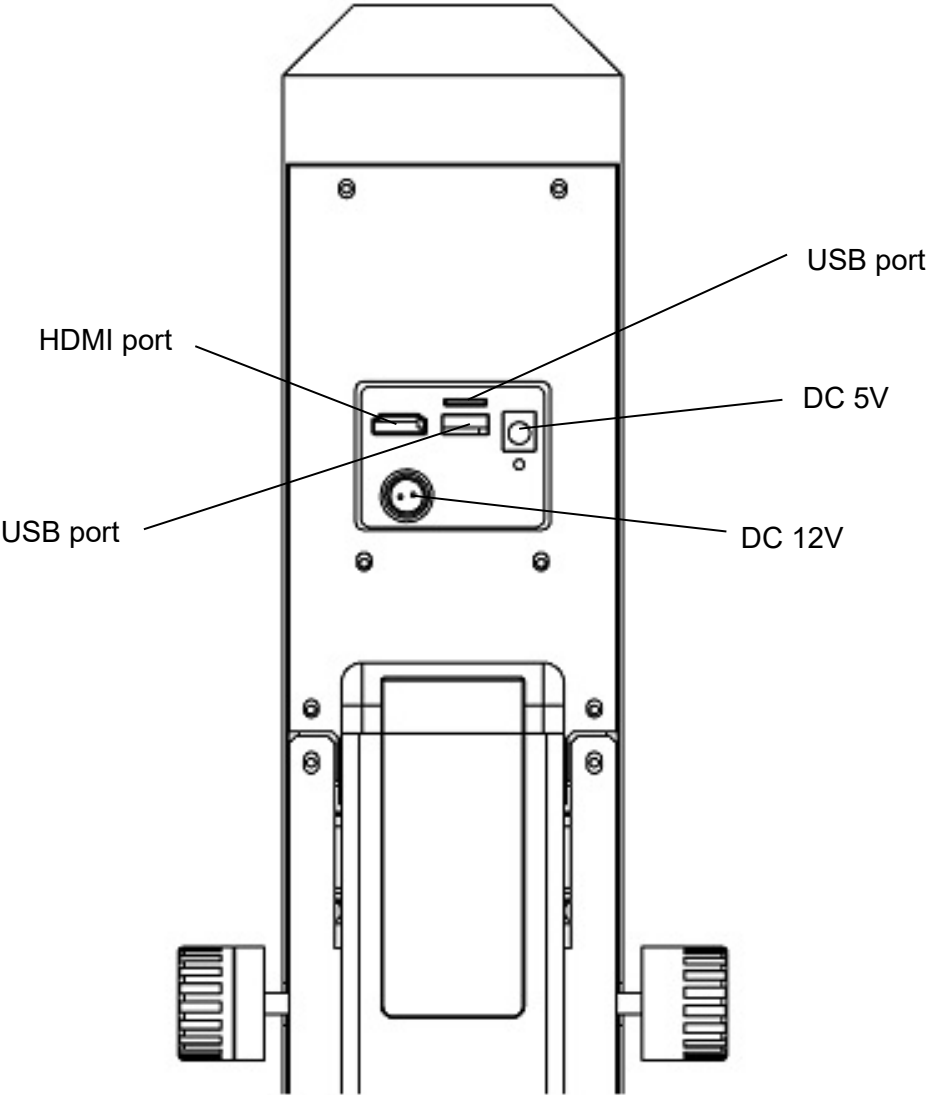

Bottom

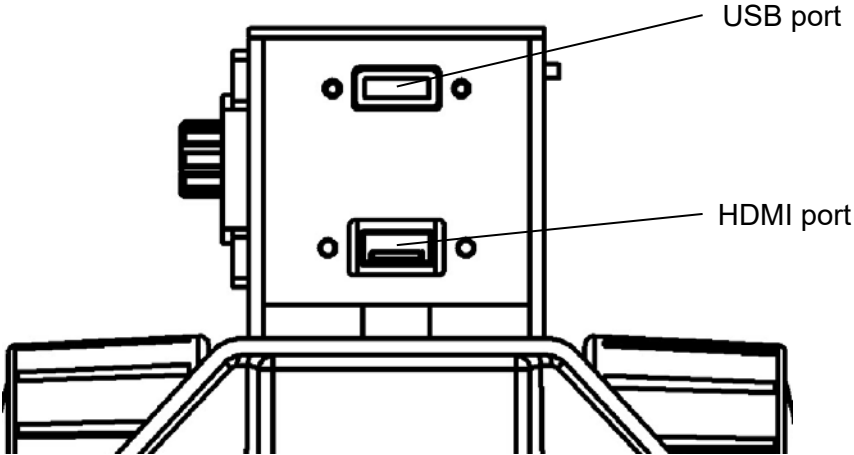

3 Basic data

Optical system	Axial
Lighting	3W LED ring light
Lighting dimmable	Yes
Stand	Mechanical
Optical zoom	0.7x – 4,5x
Magnification ratio	6,5:1
Working distance	91 mm
Maximum sample height	85 mm
Camera resolution	2 MP
Data storage	External via USB (Max 128 GB)
Net weight	7 kg
Dimension product WxDxH	372x285x482 mm
Gross weight	15 kg
Dimension packing WxDxH	420x350x630 mm

Standard configuration

Model	Standard - configuration					
	Resolution camera	Interface	Sensor	Field of view mm	Objective Zoom	Software functions
KERN						
OIV 656	2 MP	HDMI (30 FPS)	CMOS 1/2,8"	Ø 12,64-2,65	0,7x - 4,5x	Images and videos, documentation

4 Assembly and operation

4.1 Overview

#

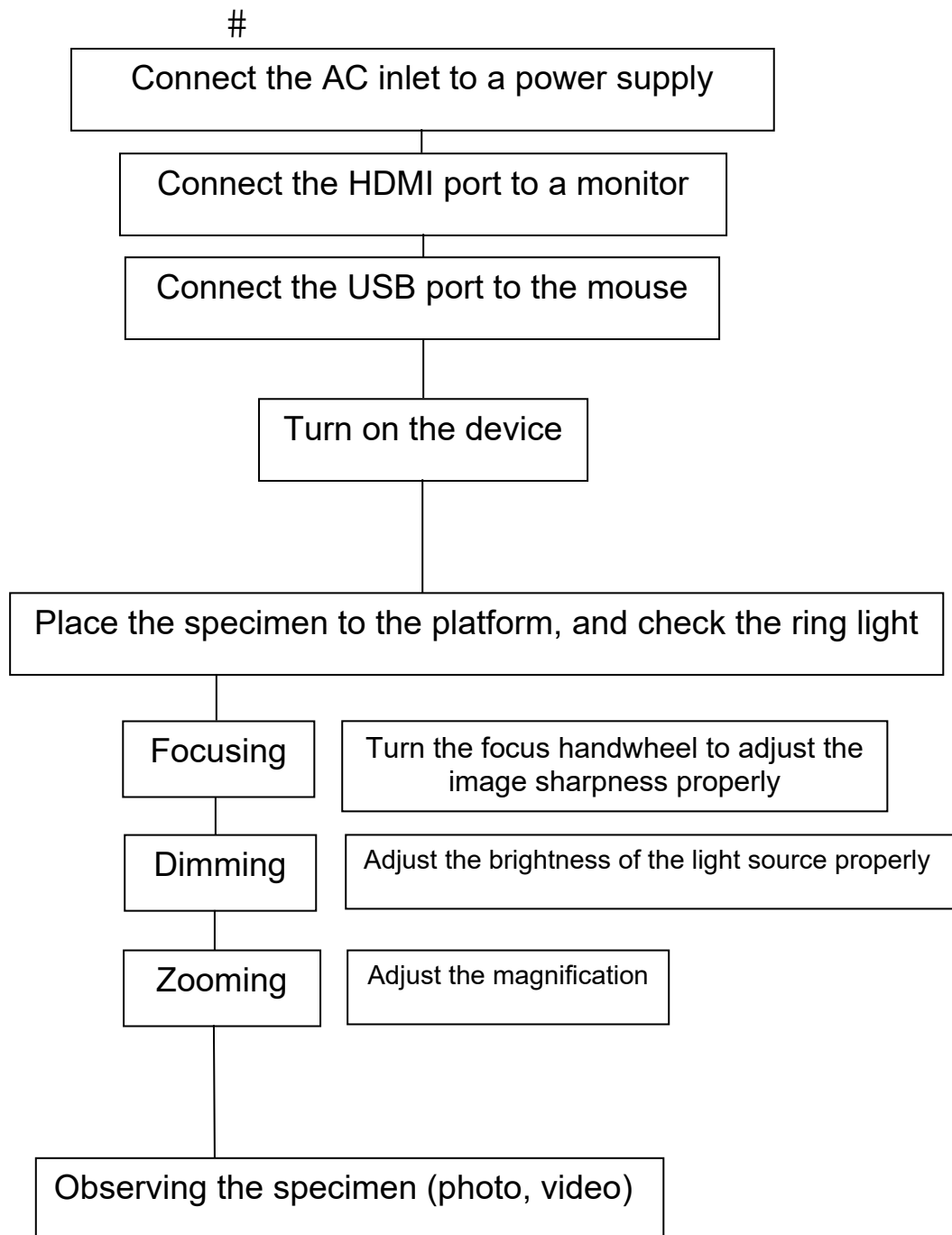

4.2 Focus, magnification and illumination

Attention: Every operation needs to be handled with care.

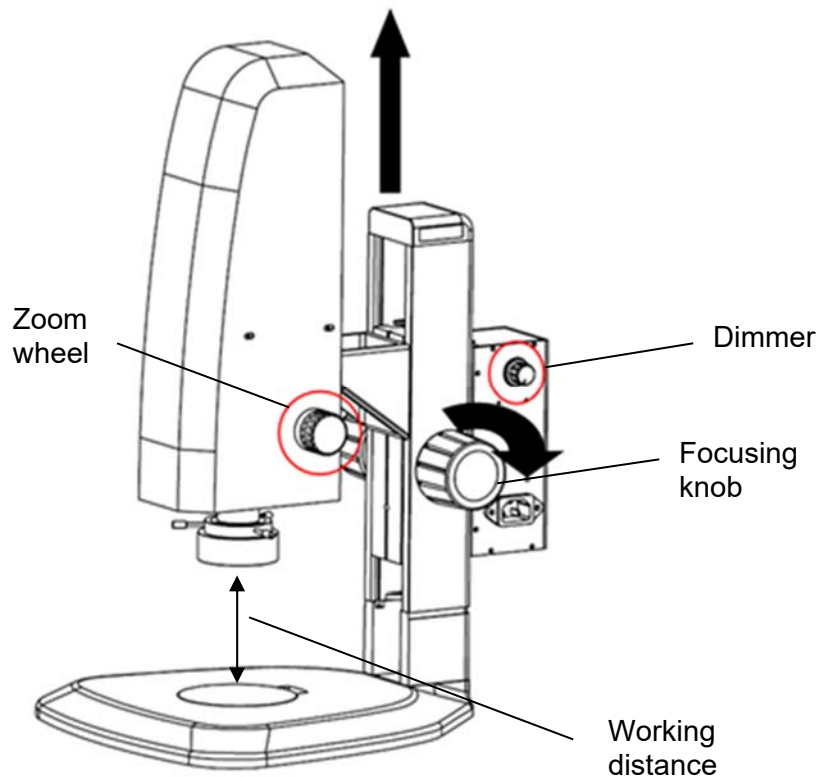

Focusing:

According to the height of the specimen set the right working distance (max. 91 mm) by turning the focusing knob. Subsequently, the auto focus function (standardly activated) will adjust the image to the maximum focus quality automatically.

The focusing area is determined by the colored focusing frame (standardly activated), which can be put to any place on the screen by a left click on the mouse.

Focusing done.

The tension of the focusing knob can be adjusted by turning both knobs in opposite directions at the same time.

Magnification:

Choose the right magnification by turning the zoom wheel.

When changing the magnification level, it might be necessary to adjust the light intensity (turn dimmer) and/or the working distance (turn focusing knob) afterwards.

The zoom wheel has a snap in function for several key magnification levels:

0.7x, 1.0x, 2.0x, 3.0x, 4.0x, 4.5x

Please don't try to turn the zoom wheel any further when set to 0.7x or 4.5x magnification, otherwise it could be damaged irreversibly.

5 Software functions

5.1 Control interface

The screenshot displays a software control interface with two tabs: "Control" (active) and "Measurement". The interface is organized into several sections:

- Focus:** A slider for MF is set to 0. Below it are buttons for "AF" (highlighted in blue), "Click F", and "MF".
- AF ROI:** A dropdown menu for "ROI Size" is set to "Small". Below are sliders for "Hor:" and "Ver:" both set to 0, and a "Set" button.
- Exposure:** Sliders for "Brigh" (set to 0), "Gain" (set to 0), and "Shutter" (set to 0). Below are buttons for "AE" (highlighted in blue) and "ME".
- Color:** Sliders for "Red", "Green", and "Blue" (all set to 0). Below are buttons for "AWB" (highlighted in blue) and "MWB".
- Function:** Sliders for "Contrast", "Sharp", "Saturati", and "Ezoom" (all set to 0). Below are icons for camera, video, folder, image, clock, and a plus sign.
- Photo Path:** A text field containing "/sdcard/img" and a dropdown menu set to ".jpg".
- Naming:** Radio buttons for "Auto" (selected) and "Custom".
- Save graphic:** Radio buttons for "yes" and "no".
- Other options:** Radio buttons for "Flip", "Mirro", and "HDR: 0". Below are buttons for "FBL", "50/60 |", "B&W", and "Default".

5.1.1 Lock menu

Click the lock icon in the upper right corner of the menu to switch the menu display status

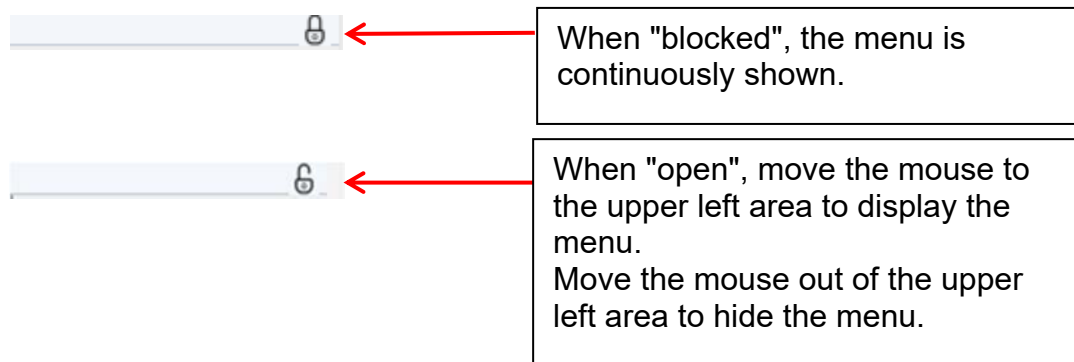

5.1.2 Focus Mode

Auto Focus \ Click Focus \ Manual Focus



Click "AF": Auto Focus. The program sets the focus automatically according to the focusing area (colored frame).

Click "Click F": Semi Auto Focus. Choose the focusing area (colored frame) on the screen by a left click on the mouse. Confirm and set focus by clicking "Click F" again.

Click "MF": Manual Focus. Turn the focusing knob on the microscope and pull the focus progress bar with the mouse in the menu to adjust the focal length and set the right focus.

5.1.3 AF ROI (Auto Focus Region of Interest / focusing frame)

ROI Size \ Focus position

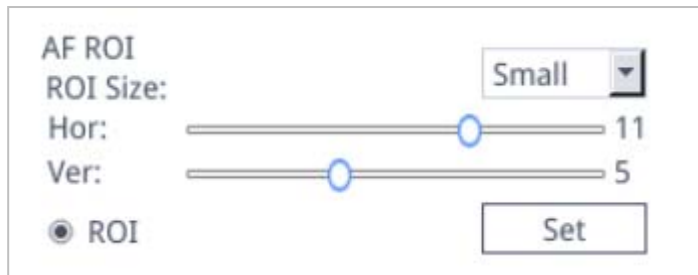

You can activate or deactivate the focusing frame by checking the "ROI".
If it is activated, you can select the ROI size and drag the progress bar to adjust the horizontal or vertical position of the focus frame.
After changing the area size or focus position, click "Set" to save the settings.

5.1.4 Exposure

Auto \ Manual

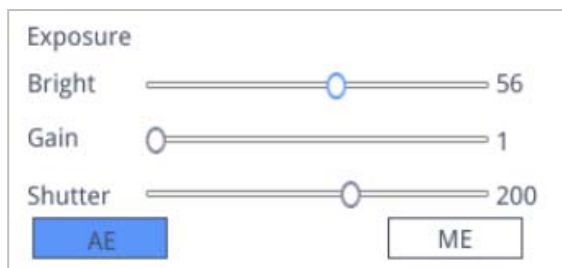

Click "AE": Set the automatic brightness target by dragging the "Bright" progress bar.

Click "ME": Set the optimum exposure by dragging the "Gain" progress bar and "Shutter" / "Exposure time" progress bar

You can go back to default auto exposure settings by clicking "Default" on the bottom of the menu.

5.1.5 White Balance

Auto \ Manual

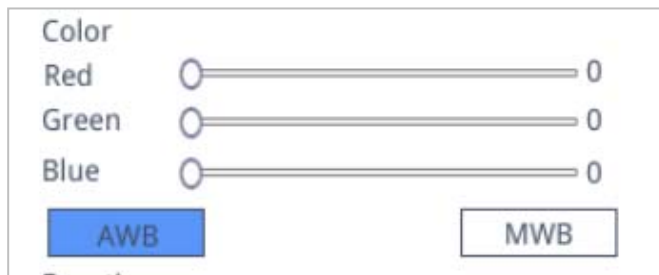

Click "AWB": Automatic white balance can be achieved under different color temperatures.

Click "MWB": You can pull the "Red / Green / Blue" progress bar to adjust the red, green, and blue color value.

5.1.6 Function

Contrast \ Sharpness \ Saturation \ Zoom



There are four more image adjustment tools.
Drag the progress bars to achieve the right settings.

5.1.7 Crosshair Tool



Click the crosshair tool

The following window shows up:

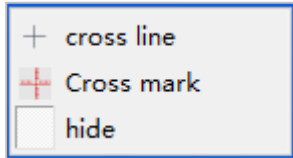

1. Select "cross line"



Set the number of horizontal and vertical lines

After the setting is complete, select "display" to set the lines on the screen, and select "delete" to hide previously set lines.

Set crosshair lines:

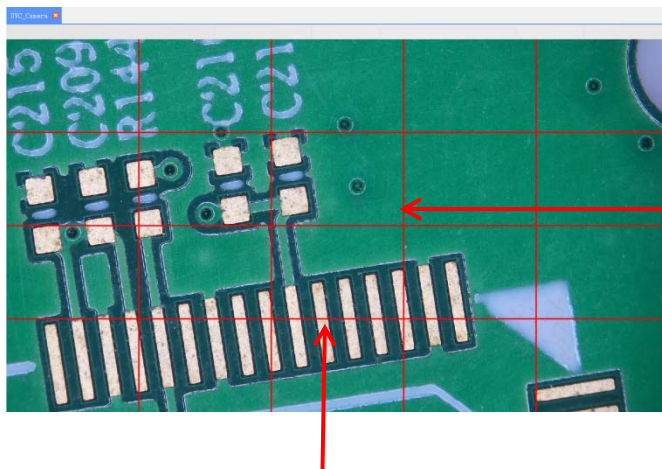

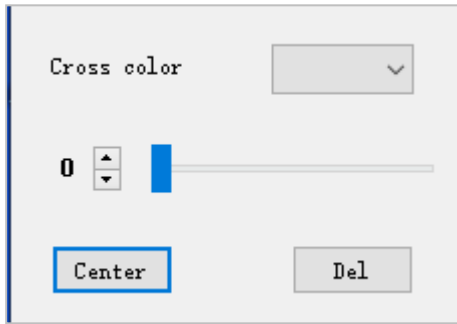

Double click of the horizontal and vertical lines to get to the settings of each line. Note: ROI has to be deactivated

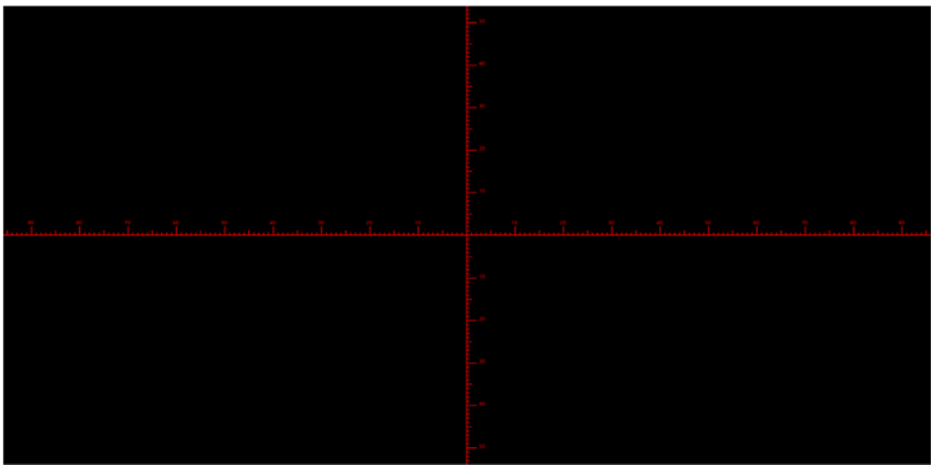

Set crosshair color and position, center and delete lines

- Click Crosshair tool , select "Cross Mark". Tick marks will appear along the crosshair lines.



- Click Crosshair tool , select "Hide". All cross lines or cross tick marks will be hidden in the image area.

- Click on the set crosshair color tool . Pull down to set the crosshair color. After the color is set, draw the crosshair again to take effect. The color of the crosshair drawn before does not change.

5.1.8 Photograph

5.1.8.1 Photograph Operation

First confirm whether the U disk is inserted successfully.



After inserting the USB flash drive for a few seconds, the icon of the successful insertion of the USB flash drive is displayed in the upper right corner of the display. Now you are able to take photos.

Click on the "photo"  icon, after about 3 seconds a photo has been captured. Pictures are automatically saved in a fixed path on the USB flash drive.

5.1.8.2 Photo Path

The photo save path is the fixed path of the camera, and it is saved in the `/mnt/sdcard/img` folder of the U disk

Photo path

5.1.8.3 Photo Format

Click on the photo format drop-down to select the photo format. There are two formats to choose: `.jpg` / `.bmp`.

5.1.8.4 Photo Naming Rules

Naming Auto Custom

Select "Auto" to name the photo according to the time, select "custom" to enter a name to save.

Input file name:

5.1.9 Recording

Click on the “record”  icon, the interface prompts "Capture start"
→ click "OK" to start recording:

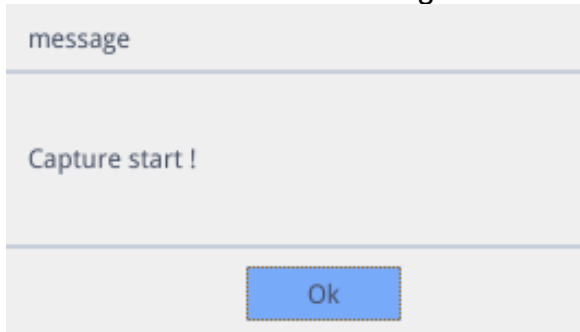

A “Rec”  symbol in the lower right corner of the screen flashes during recording.

Click on the “record”  icon again, the interface prompts "Capture stop"
→ click "OK" to stop recording

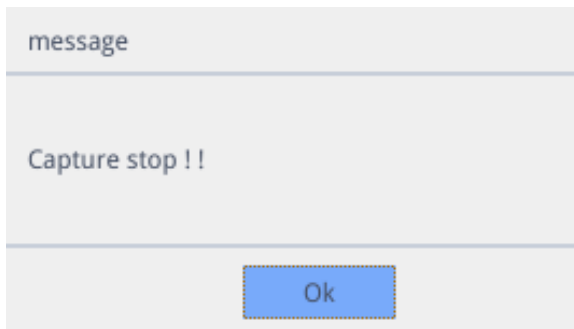

Remark: The recorded videos are named according to the date and are automatically saved in the U disk with the format of H264. The maximum length of a single recording is about 2 hours, and the size is about 4 GB. If it exceeds 2 hours, it will automatically stop recording.





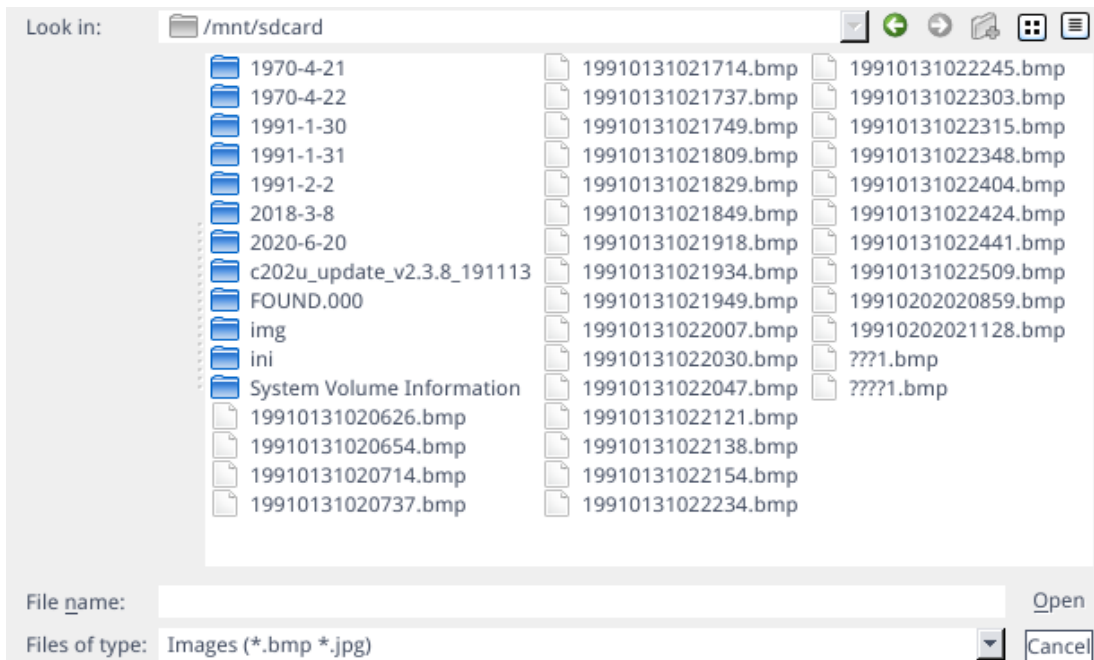

5.1.10 Open Picture

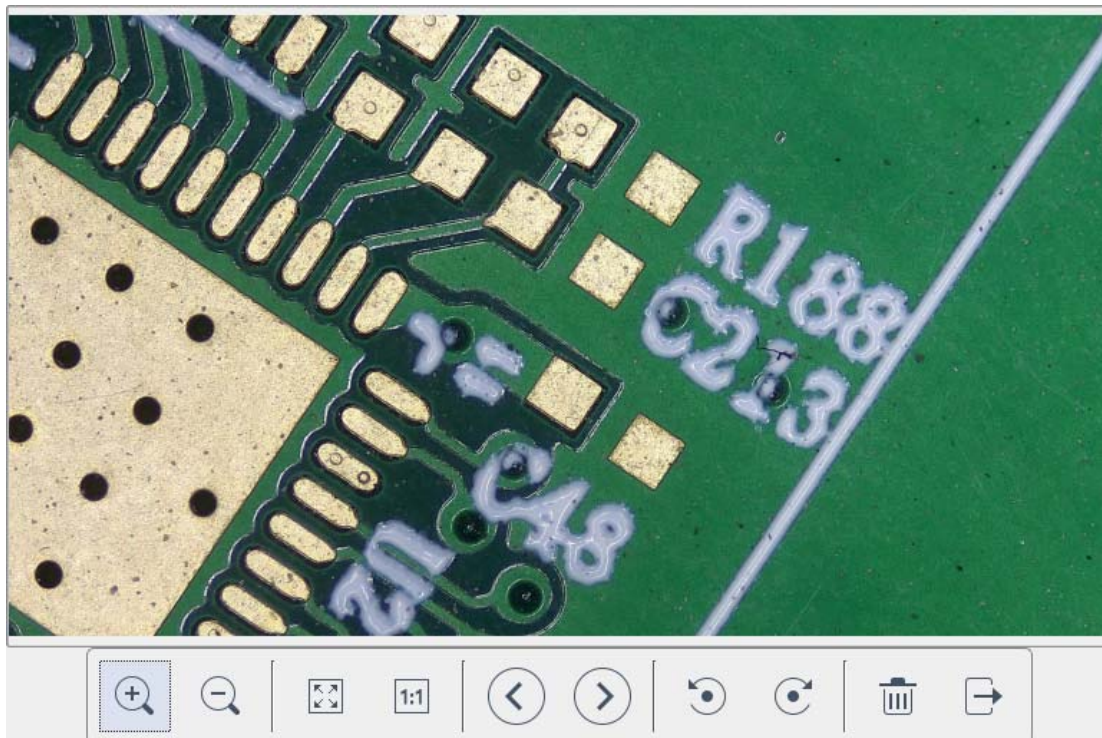
Click on the “open”  icon, the interface pops up to select the picture interface:



Select the picture you want and pop up the picture interface (Double click).



1. Click on the “scaling” tool  , to zoom in and out of pictures
2. Click on the “full screen” tool  , the picture interface displays the entire picture
3. Click on the “1:1” tool  , the picture interface displays a part of the picture. Press and hold the left mouse button to move the picture position
4. Click on the “browse” tool  , to go to previous and next pictures
5. Click on the “rotate” tool  , to change the picture direction clockwise or counterclockwise
6. Click on the “delete” tool  , to delete the current picture
7. Click on the “return” tool  , to close the current picture interface

5.1.11 Compare Pictures

Click on the “compare picture”  icon, the interface pops out to select the picture.

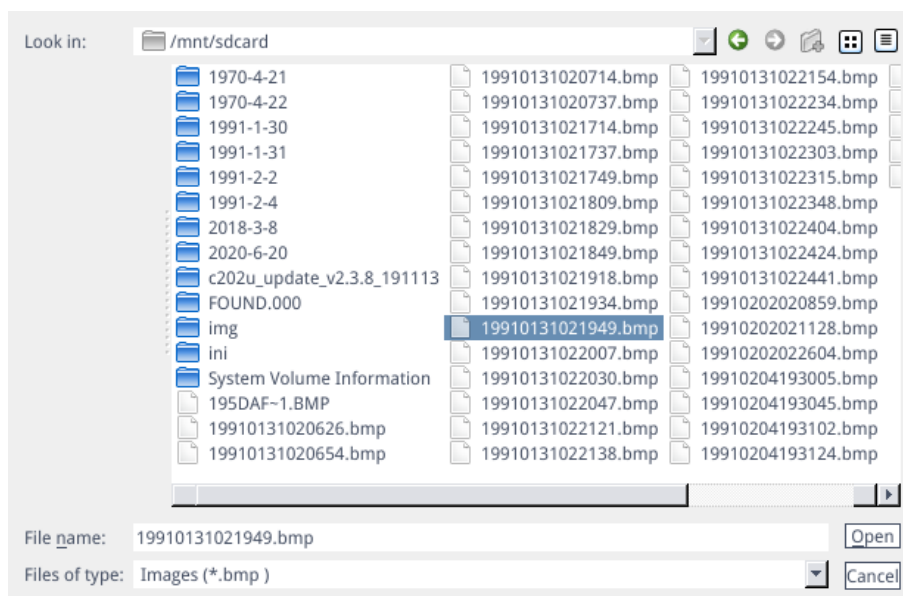

Select the picture you want to compare and pop up the comparison picture interface (Double click).

The left side of the screen is the real-time video interface, and the right side is the selected picture.

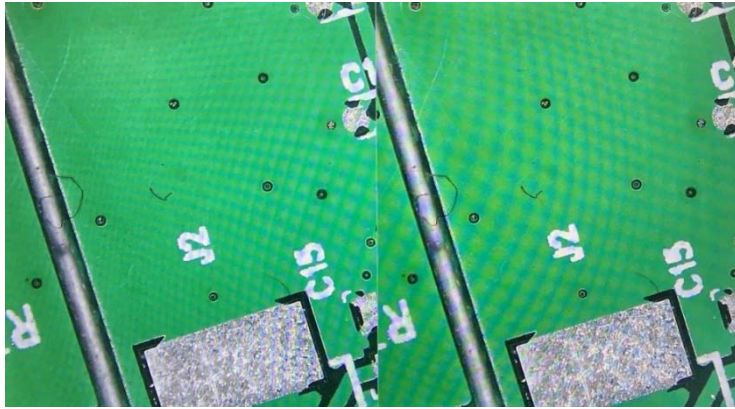

Realtime picture

Compare picture

Click on the “compare picture”  icon again to close the “compare picture” function. **Remark:** Only pictures in .bmp format are supported.

5.1.12 Time Setting

Click “Time setting”  icon, time setting interface will pop up.

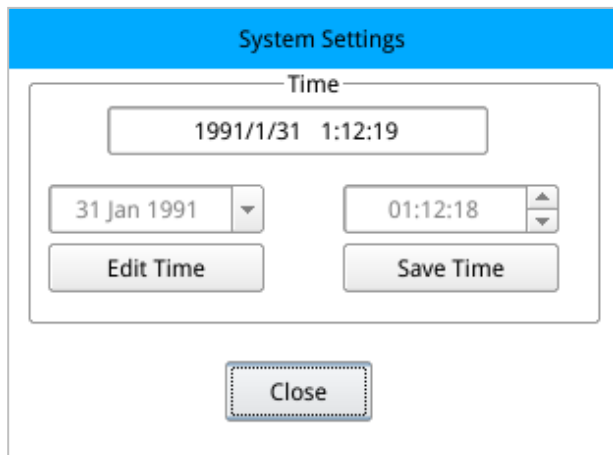

Click on “Edit Time” then click the date drop-down box to set the date. Select the hour, minute, and second to modify the time. After each time is set, you need to click on “Save Time” to save successfully. Click on “Close” to close the time setting interface.

5.1.13 Freeze

By clicking on the “Freeze”  icon, the current image interface can be frozen, and the image window remains static, which makes it easy to observe the measured object.

After freezing, the icon becomes , click  icon again to restore the real-time display interface.

5.1.14 Save Graphics

Save graphic yes no

When "Yes" is checked, the measurements / comments are saved in the picture.

If "No" is checked, only the picture will be saved.

5.1.15 Flip / Mirror

Flip Mirror

Check the "Flip":

The vertical direction of the view on the screen is the opposite of the actual.

Check the "Mirror":

The horizontal direction of the view on the screen is the opposite of the actual.

5.1.16 WDR

WDR

WDR: Check the "WDR" to reduce possible overexposures.

5.1.17 Gamma

Gamma1

Gamma settings: Values adjustable between 0-3.

5.1.18 FBL

The sensor inside the camera is able to move up and down for 16mm.

Click on "FBL" to fix the sensor to the middle position.

5.1.19 Anti screen flicker

50/60 HZ Anti-screen flicker effect is achieved after checking.

5.1.20 Black and White mode

B&W Check the "B&W" for black and white mode, default is color mode.

5.1.21 Default

Click "Default" to restore various parameters to factory settings.

5.2 Measurement interface

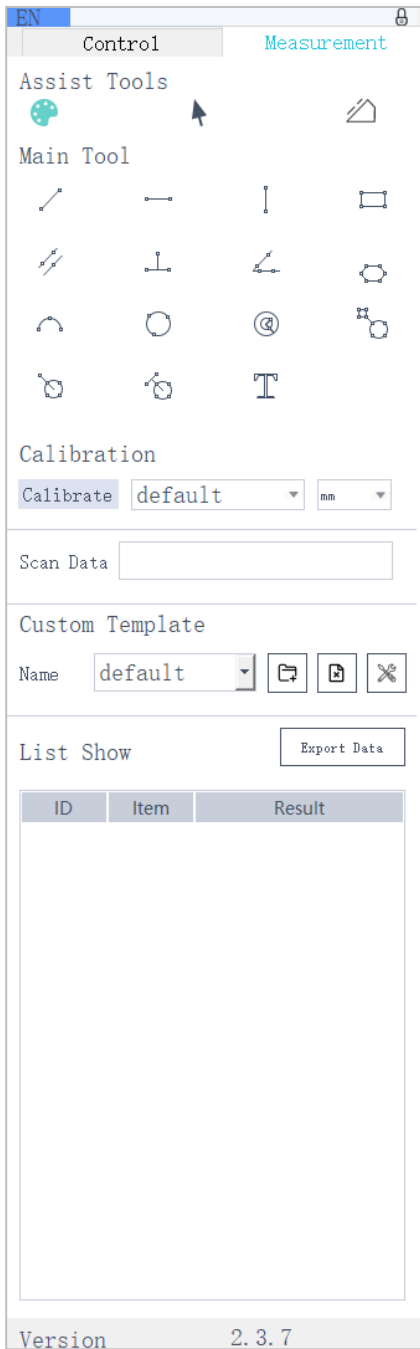

To open the measurement interface, click “Measurement” to carry out the measurement operations.

If you want to display the menu again after a measurement operation is completed, click the right mouse button in the image area and move the mouse to the menu area.

5.2.1 Assist Tool

5.2.1.1 Color Settings

Click on the “color setting”  icon, the setting interface will pop up.

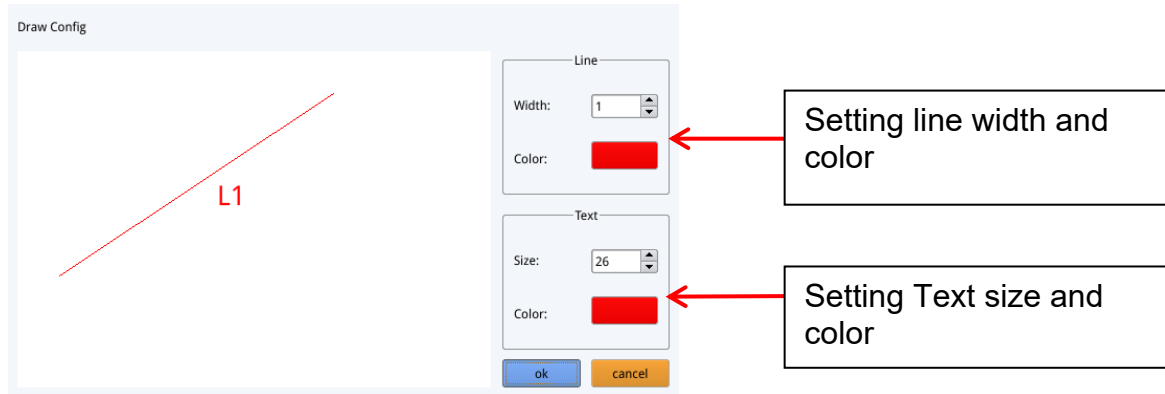



5.2.1.2 Measurement Mode

After operating the measurement, the measurement icon  automatically becomes selected and the program automatically enters the measurement mode.

The focus mode and focus area can no longer be operated. Click the measurement symbol  again with the left mouse button to operate the focus mode and focus area.

5.2.1.3 Edge Detection

Click on the “Edge Detection”  icon. When selected, the icon turns blue . When measuring a picture, it will automatically find the edges. Move your mouse near an edge and press the left mouse button. It will automatically jump to the edge.

5.2.2 Measurement Tool

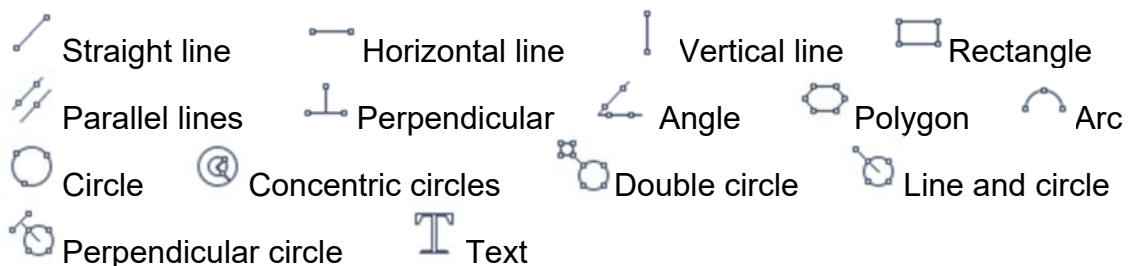

5.2.4 Custom Template

After drawing the template layout by using the measurement tools in the image area, click the “New”  icon and the window "whether Convert primitives to a template" pops up.

Click "Ok" to create a new template.

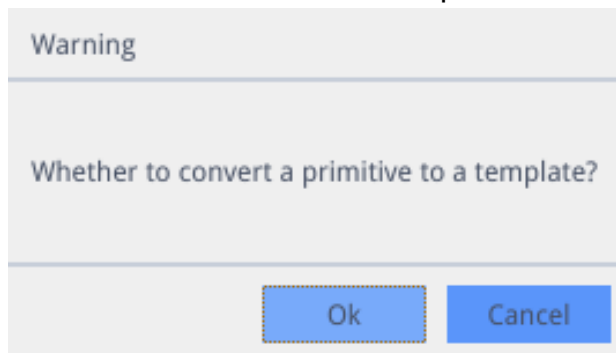



After entering a name in the name window, click the “save”  icon to save the template.

Click the “delete”  icon, to delete this template.

Click the “edit”  icon to modify the template.

Click the “save”  icon again to save the modified template.

Click the “save as”  icon to create a (modified) copy under another name.

If clicking the “back”  icon it will not save the modified template.

5.2.5 Measurement Operation

5.2.5.1 Calibration

1. Click on the calibration tool drop down.

Line Calibration, H Calibrate or Circle Calibrate can be chosen.

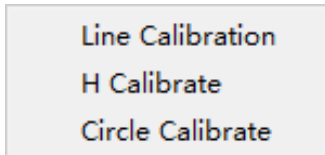

2. Drag the marking line to align with the engraved line of your calibration scale, input name and length, select the unit and complete the calibration.

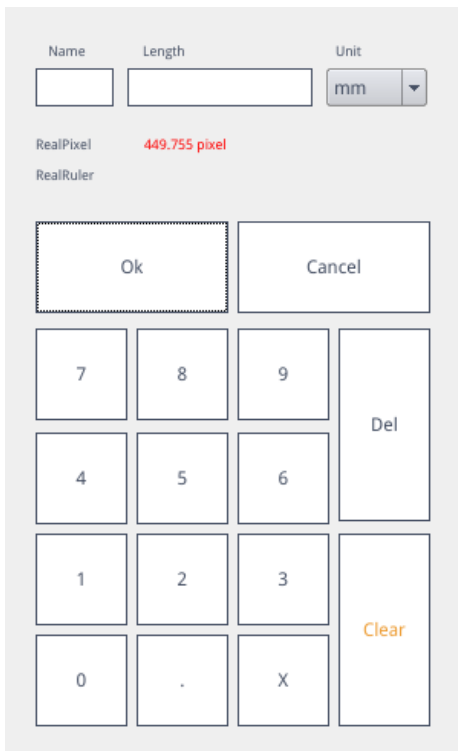

Delete calibration:

Click the drop down calibration list, select the calibration to be deleted, and click the delete icon to delete this calibration.



5.2.5.2 Measuring

The measurement tool includes a variety of stitch measurements. Depending on the specific application, you can first select the appropriate calibration and unit.

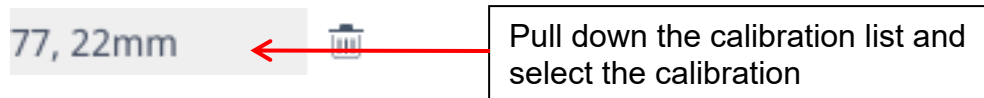

Then select the appropriate tool for measurement. When measuring, the first click is the anchor point of the measurement. After moving the mouse and clicking again the end point or further anchor points are created. After finishing a measurement, the measurement data is displayed in the measurement data list area.

ID	Item	Result
1	Circle	Rad=136.400pixel CLen=857.027pixel Area=58449.156pixel

A callout box with a red arrow pointing to the table above. The callout box contains the text: 'List of measurement data'.

After all measurements are completed, you can export the data in the measurement data list. Click “Export Data”, and the data will automatically be saved in a .csv file on the USB flash drive. The user can input the file name.

A dialog box titled 'Input file name:'. It contains a text input field, an 'Ok' button, and a 'Cancel' button.

Delete measurement data:

In the measurement data list, select the data you want to delete with a right-click, you will be prompted to delete one item of the data list, or the whole data list.

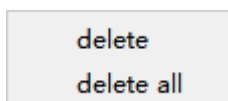

5.2.5.3 Select Measurement Data

Click the data in the measurement data list with the left mouse button. The selected item (incl. measurement data) is highlighted in the image display area with the reverse of the set color.

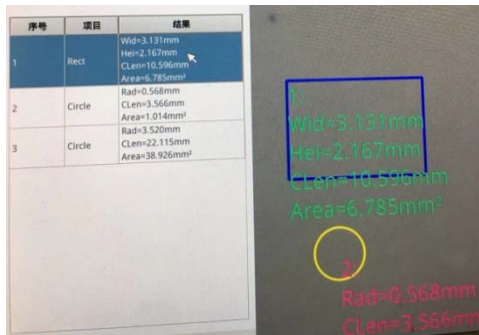

When the data in the measurement data list is selected, the image color becomes the inverse color of the set color

5.2.5.4 Selected item

Double-click the data in the measurement data list with the left mouse button and the selected item data will pop up in a dialog box.

You can modify the color and line width of the item and lock it. The locked item can no longer be operated in the image display area.

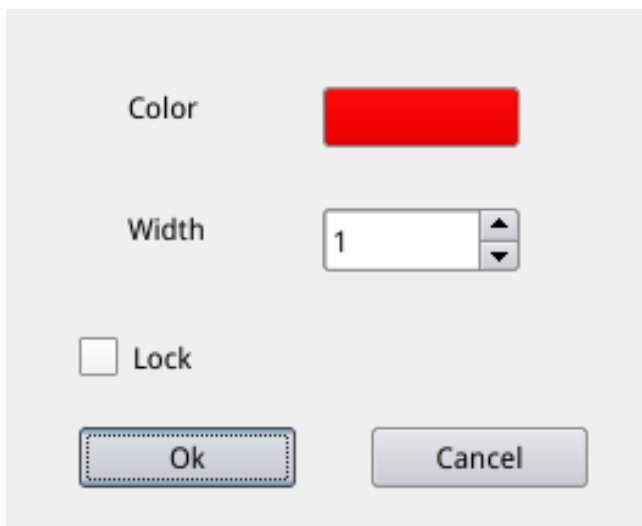

5.2.5.5 Detailed Data

Double-click the “List Show”  icon with the left mouse button to pop up the detailed data dialog box to view all the current detailed measurement data.

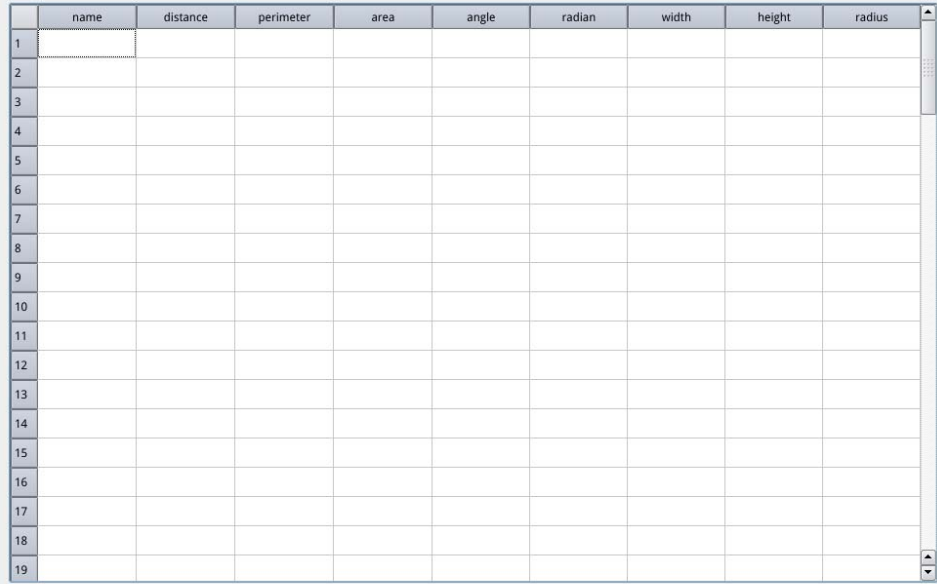

	name	distance	perimeter	area	angle	radian	width	height	radius
1									
2									
3									
4									
5									
6									
7									
8									
9									
10									
11									
12									
13									
14									
15									
16									
17									
18									
19									

5.2.5.6 Mark Tool

Click “Text”  icon.

Draw an arrow at the position to be marked in the image area, enter the comment content in the pop-up window, and click "OK" to complete the marking.



Please enter the comment content:

7 Optional equipment

Accessories	
Attachment lens 0.5x	OZB-A6101
Attachment lens 2.0x	OZB-A6102

8 Troubleshooting

NO.	Problems	Cause	Solutions
1	Poor visibility	- Some dirt on the lens or dirty surface - Focus is not correct	- Clean the lens and surfaces - Adjust the focus
2	In the process of observation, the microscope head slides down automatically, the image is not clear	Focusing knob is too loose	Appropriately adjust tension of the focusing knob
3	Illumination does not work	Power supply connection is bad	Check the power connections
4	No image on the monitor	HDMI cable	Check the HDMI cable connection
5	Incorrect image zoom	Monitor resolution settings	Set the appropriate resolution in the monitor menu
7	Focus adjustment is too coarse	Focusing knob is too tight	Appropriately adjust tension of the focusing knob

9 Service

If, despite studying these operating instructions, you still have questions about commissioning or operation, or if, contrary to expectations, a problem should occur, please contact your specialist dealer. The unit may only be opened by trained service technicians authorised by KERN.

10 Disposal

The packaging is made of environmentally friendly materials that you can dispose of at local recycling points. Disposal of the storage box and unit must be carried out by the operator in accordance with the valid national or regional law of the user's location.

11 Further information

The illustrations may differ slightly from the product.

The descriptions and illustrations in these operating instructions are subject to change without notice. Further developments to the unit may entail such changes.



All language versions include a non-binding translation.
The original German document is binding.

