

# **Automation PC 3100**

## **User's manual**

Version: **2.13 (November 2021)**  
Order no.: **MAAPC3100-ENG**

**Translation of the original documentation**

## **Publishing information**

B&R Industrial Automation GmbH

B&R Strasse 1

5142 Eggelsberg

Austria

Telephone: +43 7748 6586-0

Fax: +43 7748 6586-26

[office@br-automation.com](mailto:office@br-automation.com)

## **Disclaimer**

All information in this manual is current as of its creation. The contents of this manual are subject to change without notice. B&R Industrial Automation GmbH assumes unlimited liability in particular for technical or editorial errors in this manual only (i) in the event of gross negligence or (ii) for culpably inflicted personal injury. Beyond that, liability is excluded to the extent permitted by law. Liability in cases in which the law stipulates mandatory unlimited liability (such as product liability) remains unaffected. Liability for indirect damage, consequential damage, business interruption, loss of profit or loss of information and data is excluded, in particular for damage that is directly or indirectly attributable to the delivery, performance and use of this material.

B&R Industrial Automation GmbH notes that the software and hardware designations and brand names of the respective companies used in this document are subject to general trademark, brand or patent protection.

Hardware and software from third-party suppliers referenced in this manual is subject exclusively to the respective terms of use of these third-party providers. B&R Industrial Automation GmbH assumes no liability in this regard. Any recommendations made by B&R Industrial Automation GmbH are not contractual content, but merely non-binding information for which no liability is assumed. When using hardware and software from third-party suppliers, the relevant manuals of these third-party suppliers must additionally be consulted and, in particular, the safety guidelines and technical specifications contained therein must be observed. The compatibility of the products from B&R Industrial Automation GmbH described in this manual with hardware and software from third-party suppliers is not contractual content unless this has been separately agreed in individual cases; in this respect, warranty for such compatibility is excluded in any case, and it is the sole responsibility of the customer to verify this compatibility in advance.

<b>1 Introduction.....</b>	<b>9</b>
1.1 Manual history.....	9
1.2 Information about this document.....	10
1.2.1 Organization of safety notices.....	10
1.2.2 Guidelines.....	10
<b>2 General safety guidelines.....</b>	<b>11</b>
2.1 Intended use.....	11
2.2 Protection against electrostatic discharge.....	11
2.2.1 Packaging.....	11
2.2.2 Regulations for proper ESD handling.....	11
2.3 Regulations and measures.....	12
2.4 Transport and storage.....	12
2.5 Installation.....	12
2.6 Operation.....	12
2.6.1 Protection against contact with electrical parts.....	12
2.6.2 Ambient conditions - Dust, moisture, aggressive gases.....	13
2.6.3 Programs, viruses and malicious programs.....	13
2.7 Cybersecurity disclaimer for products.....	13
<b>3 System overview.....</b>	<b>14</b>
3.1 Information about this user's manual.....	14
3.2 Optimized mid-range performance.....	14
3.3 Versatility through modularity.....	14
3.4 Broad performance spectrum.....	14
3.5 Features.....	15
3.6 Configuration.....	16
3.7 Overview.....	18
<b>4 Technical data.....</b>	<b>20</b>
4.1 Complete system.....	20
4.1.1 Connection options.....	20
4.1.1.1 SDL operation.....	20
4.1.1.2 DVI operation.....	22
4.1.1.3 SDL4 operation.....	24
4.1.2 Product information.....	25
4.1.2.1 Identification.....	25
4.1.3 Mechanical properties.....	26
4.1.3.1 Dimensions.....	26
4.1.3.2 Drilling template.....	26
4.1.3.3 Spacing for air circulation.....	27
4.1.3.4 Mounting orientations.....	28
4.1.3.5 Weight specifications.....	29
4.1.4 Environmental properties.....	30
4.1.4.1 Temperature specifications.....	30
4.1.4.2 Relative humidity.....	35
4.1.4.3 Vibration and shock.....	35
4.1.4.4 Degree of protection.....	35
4.1.5 Electrical properties.....	36
4.1.5.1 System units - Block diagram.....	36
4.1.5.2 Power calculation.....	37
4.1.6 Device interfaces and slots.....	39
4.1.6.1 Device interface overview.....	39
4.1.6.2 +24 VDC power supply.....	40
4.1.6.3 Grounding.....	40
4.1.6.4 Ethernet interfaces.....	41
4.1.6.5 USB interfaces.....	42

4.1.6.6 CFast slots.....	43
4.1.6.7 Power and reset buttons.....	43
4.1.6.8 LED status indicators.....	44
4.1.6.9 Battery.....	45
4.1.6.10 SDL/DVI-D interface.....	46
4.1.6.11 IF option 1 slot.....	48
4.1.6.12 IF option 2 slot.....	49
4.1.6.13 IF option 3 slot.....	50
4.1.6.14 Trusted Platform Module (TPM).....	51
4.2 Individual components.....	52
4.2.1 System units.....	52
4.2.1.1 5APC3100.KBUx-000.....	52
4.2.2 Main memory.....	56
4.2.2.1 5MMDDR.xxxx-04.....	56
4.2.3 Graphics options.....	57
4.2.3.1 5ACCLI02.DPO0-000.....	57
4.2.3.2 5ACCLI02.SDL0-000.....	59
4.2.3.3 5ACCLI02.SD40-000.....	62
4.2.4 Interface options.....	64
4.2.4.1 5AC901.I232-00.....	64
4.2.4.2 5AC901.I485-00.....	66
4.2.4.3 5AC901.ICAN-00.....	69
4.2.4.4 5AC901.ICAN-01.....	72
4.2.4.5 5AC901.IHDA-00.....	75
4.2.4.6 5AC901.ISRM-00.....	77
4.2.4.7 5AC901.IPLK-00.....	79
4.2.4.8 5AC901.IRDY-00.....	81
4.2.4.9 5AC901.ISIO-00.....	82
4.2.4.10 5AC901.IETH-00.....	84
4.2.4.11 5ACCIF02.CANE-000.....	86
4.2.4.12 5ACCIF02.FPLK-000.....	90
4.2.4.13 5ACCIF02.FPLS-000.....	93
4.2.4.14 5ACCIF02.FPSC-000.....	96
4.2.4.15 5ACCIF02.ISS0-000.....	101
4.2.4.16 5ACCIF04.FPLK-000.....	104
4.2.5 Mass storage options.....	106
4.2.5.1 5ACCMS01.MDT2-000.....	106
4.2.5.2 5ACCMSM2.xxxx-000.....	108
4.2.6 Uninterruptible power supply (UPS).....	110
4.2.6.1 Requirements.....	110
4.2.6.2 5AC901.IUPS-00.....	111
4.2.6.3 5AC901.IUPS-01.....	113
4.2.6.4 5AC901.BUPS-00.....	115
4.2.6.5 5AC901.BUPS-01.....	119
4.2.6.6 5CAUPS.xxxx-01.....	123
4.2.7 Front covers.....	125
4.2.7.1 5ACFF01.0000-00x.....	125
4.2.8 Key covers.....	126
4.2.8.1 5ACBC01.0000-00x.....	126
4.2.9 CFast cards.....	127
<b>5 Installation and wiring.....</b>	<b>128</b>
5.1 Basic information.....	128
5.1.1 Installing the Automation PC.....	130
5.1.1.1 Procedure.....	130
5.1.2 Installation information for individual deliveries / individual components.....	130
5.2 Connecting to the power grid.....	131

5.2.1 Installing the DC power cable.....	131
5.2.1.1 Wiring.....	131
5.2.2 Connecting the power supply to a B&R device.....	132
5.2.3 Grounding concept - Functional ground.....	132
5.2.4 Connecting cables.....	133
<b>6 Commissioning.....</b>	<b>134</b>
6.1 Basic information.....	134
6.2 Switching on the device for the first time.....	134
6.2.1 General information before switching on the device.....	134
6.2.2 Switching on the device.....	134
6.3 General instructions for the temperature test procedure.....	135
6.3.1 Procedure.....	135
6.3.2 Evaluating temperatures in Windows operating systems.....	135
6.3.2.1 Evaluating with the ADI Control Center.....	135
6.3.2.2 Evaluation with BurnInTest from PassMark.....	136
6.3.3 Evaluating the measurement results.....	137
6.4 Known problems / Characteristics.....	137
<b>7 Software.....</b>	<b>138</b>
7.1 UEFI BIOS options.....	138
7.1.1 General information.....	138
7.1.1.1 Adaptation for touch operation.....	138
7.1.1.2 Overview of BIOS description.....	138
7.1.2 BIOS Setup and startup procedure.....	140
7.1.2.1 Input options.....	140
7.1.3 Boot menu.....	142
7.1.4 Boot manager.....	143
7.1.5 Device manager.....	144
7.1.5.1 Intel® Rapid Storage Technology.....	144
7.1.6 Setup utility.....	146
7.1.6.1 Main.....	146
7.1.6.2 Advanced.....	148
7.1.6.3 Security.....	172
7.1.6.4 Power.....	174
7.1.6.5 Boot.....	175
7.1.6.6 Exit.....	178
7.2 Upgrade information.....	179
7.2.1 UEFI BIOS upgrade.....	179
7.2.1.1 BIOS upgrade.....	179
7.2.1.2 Procedure in the EFI shell.....	179
7.2.2 PC firmware upgrade.....	180
7.2.2.1 Procedure in Windows (ADI Control Center).....	180
7.2.2.2 Procedure in the EFI shell.....	180
7.2.2.3 Automatic firmware upgrade.....	180
7.2.3 Automation Panel firmware upgrade.....	182
7.2.3.1 Procedure in Windows (ADI Control Center).....	182
7.2.3.2 Procedure in the EFI shell.....	182
7.3 RAID configuration.....	183
7.3.1 Legacy RAID.....	184
7.3.1.1 Configuring a SATA RAID volume with the internal RAID controller.....	184
7.3.1.2 Create RAID volume.....	186
7.3.1.3 Delete RAID volume.....	187
7.3.1.4 Recovery volume options.....	188
7.3.1.5 Reset disks to non-RAID.....	189
7.3.2 UEFI RAID.....	190
7.3.2.1 Configuring a SATA RAID volume with the internal RAID controller.....	190

7.3.2.2 Create RAID volume.....	191
7.3.2.3 Delete RAID volume.....	193
7.3.2.4 Recovery volume options.....	194
7.3.2.5 Reset disks to non-RAID.....	195
7.4 Operating systems.....	196
7.4.1 Windows 10 IoT Enterprise 2019 LTSC.....	196
7.4.1.1 General information.....	196
7.4.1.2 Order data.....	196
7.4.1.3 Overview.....	196
7.4.1.4 Features.....	196
7.4.1.5 Installation.....	197
7.4.1.6 Drivers.....	197
7.4.1.7 Activation.....	198
7.4.1.8 Supported display resolutions.....	198
7.4.2 Windows 10 IoT Enterprise 2016 LTSC.....	199
7.4.2.1 General information.....	199
7.4.2.2 Order data.....	199
7.4.2.3 Overview.....	199
7.4.2.4 Features.....	199
7.4.2.5 Installation.....	200
7.4.2.6 Drivers.....	200
7.4.2.7 Activation.....	200
7.4.2.8 Characteristics, limitations.....	201
7.4.2.9 Supported display resolutions.....	201
7.4.3 B&R Linux 10 (GNU/Linux).....	202
7.4.3.1 General information.....	202
7.4.3.2 Order data.....	202
7.4.3.3 Overview.....	202
7.4.3.4 Features.....	202
7.4.3.5 Installation.....	202
7.4.3.6 Drivers.....	202
7.4.4 B&R Linux 9 (GNU/Linux).....	203
7.4.4.1 General information.....	203
7.4.4.2 Order data.....	203
7.4.4.3 Overview.....	203
7.4.4.4 Features.....	203
7.4.4.5 Installation.....	203
7.4.4.6 Drivers.....	204
7.5 Automation software.....	205
7.5.1 Licensing.....	205
7.5.2 Order data.....	205
7.5.3.1 Support.....	205
7.5.4 Automation Runtime.....	206
7.5.4.1 General information.....	206
7.5.4.2 Minimum versions.....	206
7.5.4.3 Information about operation with Automation Runtime.....	207
7.5.5 B&R Hypervisor.....	208
7.5.6 mapp Technology.....	209
7.6 Automation Device Interface (ADI).....	210
7.6.1 ADI driver.....	210
7.6.1.1 Installation.....	210
7.6.1.2 ADI Control Center.....	210
7.6.2 ADI Development Kit.....	211
7.6.3 ADI .NET SDK.....	212
7.6.4 ADI OPC UA Server.....	213
7.7 Key Editor.....	214
7.8 KCF Editor.....	215

7.9 HMI Service Center.....	216
7.9.1 General information.....	216
7.9.2 Order data.....	216
<b>8 Maintenance.....</b>	<b>217</b>
8.1 Changing the battery.....	217
8.1.1 Changing the battery.....	217
8.2 Replacing CFast cards.....	219
8.3 Installing the interface option and DDR4 SDRAM.....	220
8.3.1 Installing M.2 mass storage devices.....	224
8.4 Installing and connecting the UPS battery unit.....	225
8.4.1 Permissible mounting orientations.....	226
8.5 Repairs/Complaints and replacement parts.....	227
<b>9 Accessories.....</b>	<b>228</b>
9.1 General information.....	228
9.1.1 Order data.....	228
9.2 Installation accessories.....	228
9.2.1 Order data.....	228
9.3 OTB103.9x.....	229
9.3.1 General information.....	229
9.3.2 Order data.....	229
9.3.3 Technical data.....	229
9.4 Terminal block ready relay.....	230
9.4.1 OTB2104.8000.....	230
9.4.1.1 General information.....	230
9.4.1.2 Order data.....	230
9.4.1.3 Technical data.....	230
9.5 Replacement CMOS batteries.....	231
9.5.1 0AC201.91 / 4A0006.00-000.....	231
9.5.1.1 General information.....	231
9.5.1.2 Order data.....	231
9.5.1.3 Technical data.....	231
9.6 USB mass storage device.....	232
9.7 Cables.....	232
<b>10 International and national certifications.....</b>	<b>233</b>
10.1 Directives and declarations.....	233
10.1.1 CE marking.....	233
10.1.2 EMC Directive.....	233
10.2 Certifications.....	234
10.2.1 UL certification.....	234
10.2.2 EAC.....	234
10.2.3 KC.....	234
10.2.4 RCM.....	234
10.2.5 DNV certification.....	235
10.2.6 UL Haz. Loc. certification.....	236
10.2.6.1 General safety guidelines.....	236
10.2.6.2 Assembly and installation.....	236
10.2.6.3 Operation.....	236
10.2.6.4 Servicing, disturbances and disassembly.....	237
10.2.6.5 USB connection with the Automation PC 3100.....	238
10.2.6.6 USB connection with optional DisplayPort graphics option.....	240
<b>11 Environmentally friendly disposal.....</b>	<b>242</b>
11.1 Separation of materials.....	242

<b>Appendix A Maintenance Controller Extended (MTCX)</b> .....	<b>243</b>
<b>Appendix B Reading LED status indicators</b> .....	<b>244</b>
<b>Appendix C Cable data</b> .....	<b>245</b>
C.1 RS232 - Bus length and cable type.....	245
C.2 RS422 - Bus length and cable type.....	245
C.3 RS485 - Bus length and cable type.....	246
C.4 CAN - Bus length and cable type.....	246
<b>Appendix D POWERLINK</b> .....	<b>247</b>
D.1 LED "S/E" (status/error LED).....	247
D.1.1 Ethernet mode.....	247
D.1.2 POWERLINK V2 mode.....	247
D.1.3 System stop error codes.....	249
D.1.4 POWERLINK V2.....	249
<b>Appendix E Abbreviations</b> .....	<b>250</b>



# 1 Introduction

## Information:

B&R makes every effort to keep documents as current as possible. The most current versions can be downloaded from the B&R website ([www.br-automation.com](http://www.br-automation.com)).

## 1.1 Manual history

Version	Date	Comment <sup>1)</sup>
2.13	November 2021	<ul style="list-style-type: none"> <li>Updated document.</li> </ul>
2.12	November 2021	<ul style="list-style-type: none"> <li>Updated document.</li> <li>EN 60950 replaced by IEC 61010-2-201.</li> <li>Updated "UEFI BIOS options" on page 138.</li> <li>Updated the CAN interface description, see sections "Interface options" on page 64 and "Cable data" on page 245.</li> </ul>
2.11	October 2021	<ul style="list-style-type: none"> <li>Updated document.</li> <li>Updated "Uninterruptible power supply (UPS)" on page 110.</li> <li>Updated "Interface options" on page 64.</li> <li>Updated "Automation software" on page 205.</li> <li>Updated "Maximum ambient temperature for worst-case operation" on page 30, "DNV certification " on page 235 and "UL Haz. Loc. certification " on page 236.</li> <li>Updated "Maintenance" on page 217.</li> </ul>
2.10	January 2021	<ul style="list-style-type: none"> <li>Updated document.</li> </ul>
2.05	December 2020	<ul style="list-style-type: none"> <li>Updated document.</li> <li>Updated "5ACCMS01.MDT2-000" on page 106, "5ACCMSM2.xxxx-000" on page 108 and "5ACCIF04.F-PLK-000" on page 104.</li> <li>Updated "B&amp;R Linux 10 (GNU/Linux)" on page 202 and "Windows 10 IoT Enterprise 2019 LTSC" on page 196.</li> <li>Updated "BIOS options" on page 138.</li> </ul>
2.00	November 2019	<ul style="list-style-type: none"> <li>Updated document.</li> <li>Updated interface options "5ACCIF02.ISS0-000" on page 101, "5ACCIF02.FPLS-000" on page 93 and "5ACCIF02.FPSC-000" on page 96.</li> <li>Updated section "BIOS options" on page 138.</li> <li>Updated section "System units - Block diagram" on page 36.</li> </ul>
1.00	September 2018	<ul style="list-style-type: none"> <li>First official version. <ul style="list-style-type: none"> <li>Updated section "Product information" on page 25.</li> <li>Updated interface options "5AC901.I232-00" on page 64, "5ACCIF02.CANE-000" on page 86 and "5ACCIF02.FPLK-000" on page 90.</li> <li>Updated sections "BIOS options" on page 138 and "RAID configuration" on page 183.</li> <li>Updated sections "Windows 10 IoT Enterprise 2016 LTSC" on page 199, "B&amp;R Linux 9 (GNU/Linux)" on page 203, "Automation Runtime" on page 206, "B&amp;R Hypervisor" on page 208 and "mapp Technology" on page 209.</li> <li>Updated section "Installing the interface option and DDR4 SDRAM" on page 220.</li> </ul> </li> </ul>

1) Editorial corrections are not listed.

## 1.2 Information about this document

**This document is not intended for end customers! The safety guidelines required for end customers must be incorporated into the operating instructions for end customers in the respective national language by the machine manufacturer or system provider.**

### 1.2.1 Organization of safety notices

Safety notices in this manual are organized as follows:

Safety notice	Description
<b>Danger!</b>	Failure to observe these safety guidelines and notices can result in death, severe injury or substantial damage to property.
<b>Warning!</b>	Failure to observe these safety guidelines and notices can result in severe injury or substantial damage to property.
<b>Caution!</b>	Failure to observe these safety guidelines and notices can result in injury or damage to property.
<b>Information:</b>	These instructions are important for avoiding malfunctions.

Table 1: Description of the safety notices used in this documentation

### 1.2.2 Guidelines

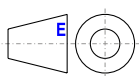

European dimension standards apply to all dimension diagrams.

**All dimensions in millimeters.**

Unless otherwise specified, the following general tolerances apply:

Nominal dimension range	General tolerance per DIN ISO 2768 medium
Up to 6 mm	±0.1 mm
Over 6 to 30 mm	±0.2 mm
Over 30 to 120 mm	±0.3 mm
Over 120 to 400 mm	±0.5 mm
Over 400 to 1000 mm	±0.8 mm

Table 2: Nominal dimension ranges

## 2 General safety guidelines

---

### 2.1 Intended use

In all cases, it is necessary to observe and comply with applicable national and international standards, regulations and safety measures!

The B&R products described in this manual are intended for use in industry and industrial applications. The intended use includes control, operation, monitoring, drive and HMI tasks as part of automation processes in machines and systems.

B&R products are only permitted to be used in their original condition. Modifications and extensions are only permitted if they are described in this manual.

B&R excludes liability for damage of any kind resulting from the use of B&R products in any intended way.

B&R products have not been designed, developed and manufactured for use that involves fatal risks or hazards that could result in death, injury, serious physical harm or other loss without the assurance of exceptionally stringent safety precautions.

B&R products are explicitly not intended for use in the following applications:

- Monitoring and control of thermonuclear processes
- Weapon systems control
- Flight and traffic control systems for passenger and freight transport
- Health monitoring and life support systems

### 2.2 Protection against electrostatic discharge

Electrical assemblies that can be damaged by electrostatic discharge (ESD) must be handled accordingly.

#### 2.2.1 Packaging

- **Electrical assemblies with housing:**  
Do not require special ESD packaging but must be handled properly (see "Electrical assemblies with housing").
- **Electrical assemblies without housing:**  
Are protected by ESD-suitable packaging.

#### 2.2.2 Regulations for proper ESD handling

##### Electrical assemblies with housing

- Do not touch the connector contacts of connected cables.
- Do not touch the contact tips on circuit boards.

##### Electrical assemblies without housing

The following applies in addition to "Electrical assemblies with housing":

- All persons handling electrical assemblies and devices in which electrical assemblies are installed must be grounded.
- Assemblies are only permitted to be touched on the narrow sides or front plate.
- Always place assemblies on suitable surfaces (ESD packaging, conductive foam, etc.). Metallic surfaces are not suitable surfaces!
- Assemblies must not be subjected to electrostatic discharges (e.g. due to charged plastics).

- A minimum distance of 10 cm from monitors or television sets must be maintained.
- Measuring instruments and devices must be grounded.
- Test probes of floating potential measuring instruments must be discharged briefly on suitable grounded surfaces before measurement.

### Individual components

- ESD protective measures for individual components are implemented throughout B&R (conductive floors, shoes, wrist straps, etc.).
- The increased ESD protective measures for individual components are not required for handling B&R products at customer locations.

## 2.3 Regulations and measures

Electronic devices are generally not failsafe. If the programmable logic controller, operating or control device or uninterruptible power supply fails, the user is responsible for ensuring that connected devices (such as motors) are brought to a safe state.

When using programmable logic controllers as well as when using operating and monitoring devices as control systems in conjunction with a Soft PLC (e.g. B&R Automation Runtime or similar product) or Slot PLC (e.g. B&R LS251 or similar product), the safety measures that apply to industrial controllers (protection by protective equipment such as emergency stops) must be observed in accordance with applicable national and international regulations. This also applies to all other connected devices, such as drives.

All work such as installation, commissioning and servicing are only permitted to be carried out by qualified personnel. Qualified personnel are persons who are familiar with the transport, installation, assembly, commissioning and operation of the product and have the appropriate qualifications for their job (e.g. IEC 60364). National accident prevention regulations must be observed.

The safety guidelines, information about connection conditions (nameplate and documentation) and limit values specified in the technical data must be read carefully before installation and commissioning and must be strictly observed.

## 2.4 Transport and storage

During transport and storage, devices must be protected against undue stress (mechanical stress, temperature, humidity, aggressive atmosphere).

## 2.5 Installation

- The devices are not ready for use and must be installed and wired according to the requirements of this documentation in order to comply with EMC limit values.
- Installation must be carried out according to the documentation using suitable equipment and tools.
- Devices are only permitted to be installed in a voltage-free state and by qualified personnel. The control cabinet must first be disconnected from the power supply and secured against being switched on again.
- General safety regulations and national accident prevention regulations must be observed.
- The electrical installation must be carried out in accordance with relevant regulations (e.g. line cross section, fuse protection, protective ground connection).

## 2.6 Operation

### 2.6.1 Protection against contact with electrical parts

In order to operate programmable logic controllers, operating and monitoring devices and uninterruptible power supplies, it is necessary for certain components to carry dangerous voltages over 42 VDC. Touching one of these components can result in a life-threatening electric shock. There is a risk of death, serious injury or damage to property.

Before switching on programmable logic controllers, operating and monitoring devices and uninterruptible power supplies, it must be ensured that the housing is properly connected to ground potential (PE rail). Ground connections must also be made if the operating and monitoring device and uninterruptible power supply are only connected for testing purposes or only operated for a short time!

Before switching on, live parts must be securely covered. All covers must be kept closed during operation.

## 2.6.2 Ambient conditions - Dust, moisture, aggressive gases

The use of operating and monitoring devices (e.g. industrial PCs, Power Panels, Mobile Panels) and uninterruptible power supplies in dusty environments must be avoided. This can otherwise result in dust deposits that affect the functionality of the device, especially in systems with active cooling (fans), which may no longer ensure sufficient cooling.

The presence of aggressive gases in the environment can also result in malfunctions. In combination with high temperature and relative humidity, aggressive gases – for example with sulfur, nitrogen and chlorine components – trigger chemical processes that can very quickly impair or damage electronic components. Blackened copper surfaces and cable ends in existing installations are indicators of aggressive gases.

When operated in rooms with dust and condensation that can endanger functionality, operating and monitoring devices such as Automation Panels or Power Panels are protected on the front against the ingress of dust and moisture when installed correctly (e.g. cutout installation). The back of all devices must be protected against the ingress of dust and moisture, however, or the dust deposits must be removed at suitable intervals.

## 2.6.3 Programs, viruses and malicious programs

Any data exchange or installation of software using data storage media (e.g. floppy disk, CD-ROM, USB flash drive) or via networks or the Internet poses a potential threat to the system. It is the direct responsibility of the user to avert these dangers and to take appropriate measures such as virus protection programs and firewalls to protect against them and to use only software from trustworthy sources.

## 2.7 Cybersecurity disclaimer for products

B&R products communicate via a network interface and were developed for secure connection with internal and, if necessary, other networks such as the Internet.

### Information:

**In the following, B&R products are referred to as "product" and all types of networks (e.g. internal networks and the Internet) are referred to as "network".**

It is the sole responsibility of the customer to establish and continuously ensure a secure connection between the product and the network. In addition, appropriate security measures must be implemented and maintained to protect the product and entire network from any security breaches, unauthorized access, interference, digital intrusion, data leakage and/or theft of data or information.

B&R Industrial Automation GmbH and its subsidiaries are not liable for damages and/or losses in connection with security breaches, unauthorized access, interference, digital intrusion, data leakage and/or theft of data or information.

The aforementioned appropriate security measures include, for example:

- Segmentation of the network (e.g. separation of the IT network from the control network<sup>1)</sup>)
- Use of firewalls
- Use of authentication mechanisms
- Encryption of data
- Use of anti-malware software

Before B&R releases products or updates, they are subjected to appropriate functional testing. Independently of this, we recommend that our customers develop their own test processes in order to be able to check the effects of changes in advance. Such changes include, for example:

- Installation of product updates
- Significant system modifications such as configuration changes
- Deployment of updates or patches for third-party software (non-B&R software)
- Hardware replacement

These tests should ensure that implemented security measures remain effective and that systems in the customer's environment behave as expected.

<sup>1)</sup> The term "control network" refers to computer networks used to connect control systems. The control network can be divided into zones, and there can be several separate control networks within a company or site. The term "control systems" refers to all types of B&R products such as controllers (e.g. X20), HMI systems (e.g. Power Panel T30), process control systems (e.g. APROL) and supporting systems such as engineering workstations with Automation Studio.

## 3 System overview

---

### 3.1 Information about this user's manual

This user's manual contains all the necessary information for a functioning Automation PC 3100 panel mount device.

#### Information:

All specifications in dimension diagrams and associated tables are in millimeters [mm].

### 3.2 Optimized mid-range performance

The Automation PC 3100 family of products combines the advantages of a compact system with very powerful Core i-series processors from the latest generation. The Automation PC 3100 needs little space in the control cabinet for this and simultaneously provides innovative modularity.



### 3.3 Versatility through modularity

Automation PC 3100 devices offer a variety of modular interface options. Up to three slots can accommodate cards for serial interfaces, Ethernet, CAN and POWERLINK. The slots can also be used for a UPS solution or audio interfaces.

A PCIe/SATA interface provides an SDL4 graphics option in addition to the onboard SDL/DVI connector or a second POWERLINK managing node for data acquisition from two separate networks.

In addition to the industry standard slots for two data storage media in CFast format with up to 256 GB per data storage medium, it is also possible to use high-performance M.2 mass storage devices on the APC3100. For even better performance or higher protection against failure, the CFast cards can also be operated as a RAID volume.

### 3.4 Broad performance spectrum

The processors are based on Intel's Core-i technology. They can be scaled over a very wide range, from Celeron to Core i7. This allows the processing power to be adapted exactly as needed to the respective application. All variants are fanless, which means that the Automation PC 3100 has no rotating parts at all. This makes maintenance tasks like replacing air filters a thing of the past. The scalable memory options range from 4 to 32 GB. This means that this PC generation can also handle very demanding applications.









## 3.5 Features

- Intel Core-i processor technology
- Powerful Intel HD graphics
- 2x Gigabit Ethernet
- 4x USB 3.0
- 2x CFast slot
- Fanless operation
- TPM 2.0 security
- +24 VDC supply voltage
- Up to 32 GB main memory
- Compact design
- Onboard SDL/DVI
- 1x USB 2.0 for Technology Guard
- Battery-backed RTC
- 3x interface option slots
- Additional graphics options (DP/DVI/SDL/SDL4)
- Up to 1024 GB M.2 mass storage





### 3.6 Configuration

The following individual components are mandatory for operation:

- System unit
- Main memory
- CFAST card or M.2 mass storage device for the operating system
- Operating system

APC3100 configuration			
<b>System units</b>			Select 1
	<b>System unit</b>		<b>Processor</b>
	5APC3100.KBU0-000		Intel C-3965U
	5APC3100.KBU1-000		Intel i3-7100U
	5APC3100.KBU2-000		Intel i5-7300U
	5APC3100.KBU3-000		Intel i7-7600U
		<b>Processor - Clock frequency</b>	<b>Cores</b>
		2200 MHz	2
		2400 MHz	2
		2600 MHz	2
		2800 MHz	2
<b>Covers</b>			Select 1 each
	<b>Front cover<sup>1)</sup></b>		
	5ACCCF01.0000-000		
	5ACCCF01.0000-001		
	5ACCCF01.0000-002		
<b>Key cover<sup>2)</sup></b>			
5ACCCBC01.0000-000			
5ACCCBC01.0000-001			
<b>Main memory</b>			Select max. 2
	5MMDDR.4096-04		
	5MMDDR.8192-04		
	5MMDDR.016G-04		
<b>Mass storage devices</b>			
	<b>CFAST cards</b>		Optional, select max. 2
	5CFAST.2048-00		5CFAST.032G-10 5CFAST.064G-10 5CFAST.128G-10 5CFAST.256G-10
	5CFAST.4096-00		
	5CFAST.8192-00		
	5CFAST.016G-00		
	5CFAST.032G-00		
<b>Interfaces</b>			
	<b>Graphics options<sup>3)</sup></b>		Optional, select max. 1
	5ACCLI02.DPO0-000		
	5ACCLI02.SDL0-000		
	5ACCLI02.SD40-000		
	<b>Mass storage options<sup>3)</sup></b>		Optional, select 1 of each
	<b>Adapter card</b>		<b>M.2 mass storage device</b>
	5ACCMS01.MDT2-000		5ACCMSM2.0512-000
			5ACCMSM2.1024-000
	<b>Interface options</b>		Optional, select max. 2
	5AC901.I232-00	5AC901.IHDA-00	5ACCF02.CANE-000
	5AC901.I485-00	5AC901.IPLK-00	5ACCF02.FPLK-000
	5AC901.ICAN-00	5AC901.IRDY-00	5ACCF02.FPLS-000
	5AC901.ICAN-01	5AC901.ISIO-00	5ACCF02.FPSC-000
	5AC901.IETH-00	5AC901.ISRM-00	5ACCF02.ISS0-000
	5ACCF04.FPLK-000		
	<b>UPS<sup>4)</sup></b>		Optional, select 1 of each
	<b>UPS module</b>		<b>Cables</b>
	5AC901.IUPS-00	<b>Battery unit</b>	5CAUPS.0005-01
	5AC901.IUPS-01	5AC901.BUPS-00	5CAUPS.0010-01
		5AC901.BUPS-01	5CAUPS.0013-01
			5CAUPS.0030-01
<b>Accessories</b>			Optional selection
	5MMUSB.2048-01		
	5MMUSB.4096-01		
	5MMUSB.032G-02		



<b>Terminal blocks</b>				Select 1
	<b>Power supply connectors</b> 0TB103.9 0TB103.91			
<b>Operating systems</b>				Select 1
  	<b>Windows 10</b> 5SWW10.0653-MUL 5SWW10.0655-MUL 5SWW10.0753-MUL 5SWW10.0755-MUL 5SWW10.1000-MUL 5SWW10.1100-MUL	<b>B&amp;R Linux 10</b> 5SWLIN.0853-MUL  <b>B&amp;R Linux 9</b> 5SWLIN.0753-MUL 5SWLIN.0755-MUL	<b>Automation Runtime</b> 0TG1000.01 0TG1000.02 1TG4600.10-5 1TG4601.06-5	

- 1) 1) If no front cover is selected during device configuration, then front cover 5ACCF01.0000-000 (orange with B&R logo) is installed and delivered by default.
- 2) If no key cover is selected during device configuration, then front cover 5ACCBC01.0000-000 (orange) is installed and delivered by default.
- 3) Select a graphics option or mass storage option.
- 4) The UPS module can only be operated in the IF option 1 slot, and the battery unit compatible with the UPS module must be used.

## 3.7 Overview

Order number	Short description	Page
	<b>Accessories</b>	
0TB103.9	Connector 24 VDC - 3-pin, female - Screw clamp terminal block 3.31 mm <sup>2</sup>	229
0TB103.91	Connector 24 VDC - 3-pin, female - Cage clamp terminal block 3.31 mm <sup>2</sup>	229
5SWUTI.0001-000	HMI Service Center USB flash drive - Hardware diagnostic software - For APC910/PPC900 - For PPC1200 - For APC2100/PPC2100 - For APC2200/PPC2200 - For APC3100/PPC3100 - For APC mobile - For AP800/AP900 - For AP9x3/AP9xD - For AP1000/AP5000	216
	<b>B&amp;R Linux 10</b>	
5SWLIN.0853-MUL	B&R Linux 10 - 64-bit - Multilingual - APC3100 Kaby Lake (UEFI boot) - Installation - Only available with a new device	202
	<b>B&amp;R Linux 9</b>	
5SWLIN.0753-MUL	B&R Linux 9 - 64-bit - Multilingual - APC3100 Kaby Lake (UEFI boot) - Installation - Only available with a new device	203
5SWLIN.0755-MUL	B&R Linux 9 - 64-bit - Multilingual - APC3100 Kaby Lake (Legacy boot) - Installation - Only available with a new device	203
	<b>Batteries</b>	
0AC201.91	Lithium batteries 4 pcs., 3 V / 950 mAh button cell	231
4A0006.00-000	Lithium battery, 3 V / 950 mAh, button cell	231
	<b>Front covers</b>	
5ACCF01.0000-000	APC3100 front cover - Orange - With B&R logo	125
5ACCF01.0000-001	APC3100 front cover - Dark gray - Without logo	125
5ACCF01.0000-002	APC3100 front cover - Orange - Without logo	125
	<b>Graphics options</b>	
5ACCLI02.DPO0-000	Graphics option - 1x DisplayPort transmitter (version 1.2) - For APC3100/PPC3100	57
5ACCLI02.SD40-000	Graphics option - 1x SDL4 transmitter (max. 1920 x 1080) - For APC3100/PPC3100	62
5ACCLI02.SDL0-000	Graphics option - 1x SDL/DVI transmitter - For APC3100/PPC3100	59
	<b>Hypervisor</b>	
1TC4700.00	License for B&R Hypervisor (TC). One license per target system is required.	205
	<b>Interface options</b>	
5AC901.I232-00	Interface card - 1x RS232 interface - For APC910/PPC900/APC3100/PPC3100	64
5AC901.I485-00	Interface card - 1x RS232/RS422/RS485 interface - For APC910/PPC900/APC3100/PPC3100	66
5AC901.ICAN-00	Interface card - 1x CAN interface - For APC910/PPC900/APC3100/PPC3100	69
5AC901.ICAN-01	Interface card - 1x CAN interface (SJA1000) - For APC910/PPC900/APC3100/PPC3100	72
5AC901.IETH-00	Interface card - 1x ETH 10/100/1000 - For APC910/PPC900/APC3100/PPC3100	84
5AC901.IHDA-00	Interface card - 1x audio interface (1x MIC / 1x Line In / 1x OUT) - For APC910/PPC900/APC3100/PPC3100	75
5AC901.IPLK-00	Interface card - 1x POWERLINK interface - 2 MB SRAM - For APC910/PPC900/APC3100/PPC3100	79
5AC901.IRDY-00	Interface card - Ready relay - For APC910/PPC900/APC3100/PPC3100	81
5AC901.ISIO-00	Interface card - System I/O - For APC910/PPC900/APC3100/PPC3100	82
5AC901.ISRM-00	Interface card - 2 MB SRAM - For APC910/PPC900/APC3100/PPC3100	77
5ACCIF02.CANE-000	Interface card - 1x CAN interface (SJA1000) - 1x ETH 10/100/1000 - For APC3100/PPC3100	86
5ACCIF02.FPLK-000	Interface card - 1x POWERLINK interface - 2 MB SRAM - Integrated 2-port hub - Ring redundancy - POWERLINK managing or controlled node - PRC function - For APC3100/PPC3100	90
5ACCIF02.FPLS-000	Interface card - 2 MB SRAM - 1x RS232 interface - 1x POWERLINK interface - For APC3100/PPC3100	93
5ACCIF02.FPSC-000	Interface card - 2 MB SRAM - 1x RS232 interface - 1x CAN interface - 1x POWERLINK interface - 1x X2X - For APC3100/PPC3100	96
5ACCIF02.ISS0-000	Interface card - 2x RS232/RS422/RS485 interface - For APC3100/PPC3100	101
5ACCIF04.FPLK-000	Interface card - 1x POWERLINK interface - For APC3100/PPC3100	104
	<b>Key covers</b>	
5ACCBC01.0000-000	APC3100 key cover - Orange	126
5ACCBC01.0000-001	APC3100 key cover - Dark gray	126
	<b>Main memory</b>	
5MMDDR.016G-04	SO-DIMM DDR4, 16384 MB	56
5MMDDR.4096-04	SO-DIMM DDR4, 4096 MB	56
5MMDDR.8192-04	SO-DIMM DDR4, 8192 MB	56
	<b>Mass storage options</b>	
5ACCMS01.MDT2-000	Adapter card for M.2 mass storage device - For APC3100/PPC3100	106
5ACCMSM2.0512-000	512 GB M.2 SSD MLC - Innodisk - SATA	108
5ACCMSM2.1024-000	1 TB M.2 SSD MLC - Innodisk - SATA	108
	<b>Other</b>	
5ACCRHMI.0006-000	HMI installation tool for control cabinet - 1x torque wrench ESD 0.3 - 1.2 Nm - 1x hex-head bit 2.5, length 89 mm - 1x hex-head bit 3.0, length 89 mm - 1x hex-head bit 5.0, length 89 mm - 1x Torx 10 bit, length 90 mm - 1x Torx 20 bit, length 89 mm	228
	<b>Runtime</b>	
1TC4601.06-5	License for Automation Runtime Embedded (TC). One license per target system is required.	205
	<b>System units</b>	
5APC3100.KBU0-000	APC3100 system unit - Intel Celeron 3965U 2.2 GHz - Dual core	53
5APC3100.KBU1-000	APC3100 system unit - Intel Core i3 7100U 2.4 GHz - Dual core	53
5APC3100.KBU2-000	APC3100 system unit - Intel Core i5 7300U 2.6 GHz - Dual core	53
5APC3100.KBU3-000	APC3100 system unit - Intel Core i7 7600U 2.8 GHz - Dual core	53
	<b>Technology Guard</b>	
0TG1000.01	Technology Guard (MSD)	205
0TG1000.02	Technology Guard (HID)	205
0TGF016.01	Technology Guard (MSD) with integrated flash drive, 16 GB (MLC)	205
1TG4600.10-5	Automation Runtime Windows TG license	205

Order number	Short description	Page
1TG4601.06-5	Automation Runtime Embedded, TG license	205
1TG4601.06-T	Automation Runtime Embedded Terminal TG license	205
1TG4700.00	B&R Hypervisor	205
<b>Terminal blocks</b>		
0TB2104.8000	Connector 24 VDC - 4-pin female - Screw clamp terminal block 2.5 mm <sup>2</sup>	230
<b>Uninterruptible power supply</b>		
5AC901.BUPS-00	Battery unit 4.5 Ah - For UPS 5AC901.IUPS-00	115
5AC901.BUPS-01	Battery unit 2.2 Ah - For UPS 5AC901.IUPS-01	119
5AC901.IUPS-00	UPS - For 4.5 Ah battery	111
5AC901.IUPS-01	UPS - For 2.2 Ah battery	113
5CAUPS.0005-01	UPS cable - 0.5 m - For 5AC901.IUPS-xx	123
5CAUPS.0010-01	UPS cable - 1 m - For 5AC901.IUPS-xx	123
5CAUPS.0013-01	UPS cable - 1.3 m - For 5AC901.IUPS-xx	123
5CAUPS.0030-01	UPS cable - 3 m - For 5AC901.IUPS-xx	123
<b>Windows 10 IoT Enterprise 2016 LTSB</b>		
5SWW10.0653-MUL	Windows 10 IoT Enterprise 2016 LTSB - 64-bit - Value - Multilingual - APC3100 Kaby Lake (UEFI boot) - CPU Celeron/Core i3/Core i5 - License - Only available with a new device	199
5SWW10.0655-MUL	Windows 10 IoT Enterprise 2016 LTSB - 64-bit - Value - Multilingual - APC3100 Kaby Lake (Legacy BIOS boot) - CPU Celeron/Core i3/Core i5 - License - Only available with a new device	199
5SWW10.0753-MUL	Windows 10 IoT Enterprise 2016 LTSB - 64-bit - High End - Multilingual - APC3100 Kaby Lake (UEFI boot) - CPU Core i7 - License - Only available with a new device	199
5SWW10.0755-MUL	Windows 10 IoT Enterprise 2016 LTSB - 64-bit - High End - Multilingual - APC3100 Kaby Lake (Legacy BIOS boot) - CPU Core i7 - License - Only available with a new device	199
<b>Windows 10 IoT Enterprise 2019 LTSC</b>		
5SWW10.1000-MUL	Windows 10 IoT Enterprise 2019 LTSC: - 64-bit - Value - Multilingual - License - Only available with a new device	196
5SWW10.1100-MUL	Windows 10 IoT Enterprise 2019 LTSC: - 64-bit - High End - Multilingual - License - Only available with a new device	196

# 4 Technical data

## 4.1 Complete system

### 4.1.1 Connection options

An Automation Panel can be connected to the Automation PC via the onboard DVI-D/SDL interface and via an optional graphics option. The connection options described in the following provide an overview of the operating modes and possible limitations.

#### 4.1.1.1 SDL operation

##### 4.1.1.1.1 SDL operation without USB cable (mode 1)

With this connection option, all communication between the Automation Panel and B&R industrial PC takes place via a single SDL cable.

In addition to the display data, information from the touch screen, matrix keys, LEDs and service/diagnostic data is transferred. The Automation Panel can be installed up to 40 m away from the B&R industrial PC. USB 1.1 is also transferred over this distance and fully integrated into SDL. External adapter modules are not required.

The brightness of the display can be set via the ADI Control Center, for example.

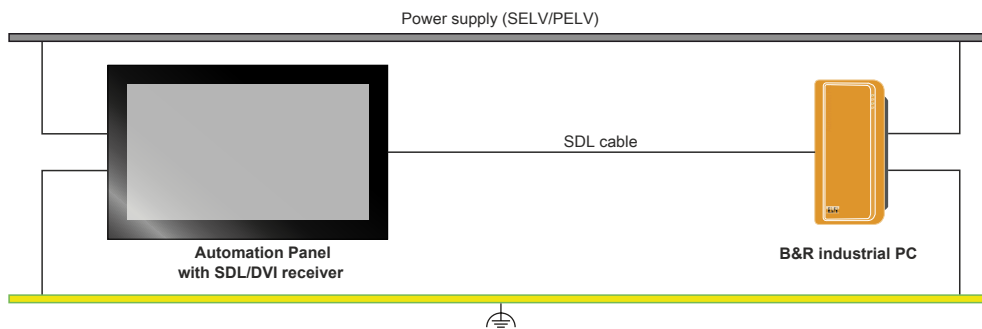

#### Availability of the interfaces on the Automation Panel with SDL/DVI receiver:

Panel In	✓	USB In	✗	Power supply	✓	Brightness controls	✗
USB1, USB2	✓	COM interface for touch screen	✗	Grounding	✓		
		USB 1.1					

Maximum cable length: 40 m

#### Requirements

- Automation Panel with SDL/DVI receiver
- B&R industrial PC with SDL interface
- SDL cable

#### 4.1.1.1.2 SDL operation with USB cable (mode 2)

With this connection option, communication between the Automation Panel and B&R industrial PC takes place via an SDL cable that is connected to interface "Panel In" and a USB type A/B cable that is connected to interface "USB In".

Display data as well as information from the resistive touch screen keys, matrix keys, LEDs and service/diagnostic data is transferred via the SDL cable. The touch screen data from the multi-touch screen is transferred via the USB type A/B cable. The Automation Panel can be installed up to 5 m (USB specification) away from the B&R industrial PC. USB 2.0 can be transferred over this distance via the USB type A/B cable. External adapter modules are not required.

The brightness of the display can be set via the ADI Control Center, for example.

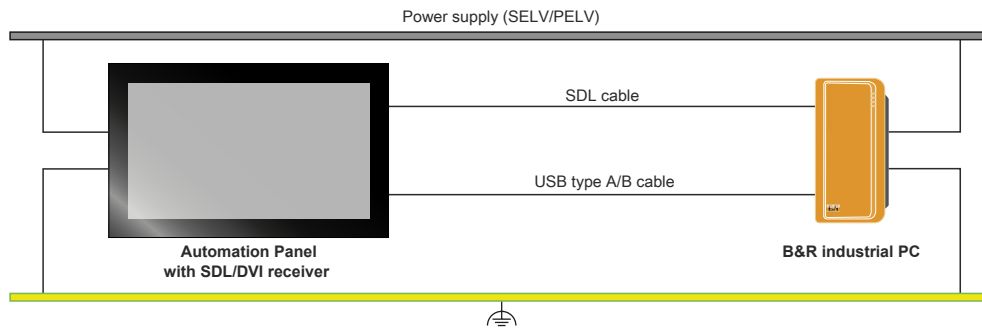

**Availability of the interfaces on the Automation Panel with SDL/DVI receiver:**

Panel In	✓	USB In	✓	USB 2.0	✓	Power supply	✓	Brightness controls	✗
USB1, USB2	✓	USB 2.0	✗	COM interface for touch screen	✗	Grounding	✓		

Maximum cable length: 5 m

**Requirements**

- Automation Panel with SDL/DVI receiver
- B&R industrial PC with SDL interface
- SDL cable, USB type A/B cable

### 4.1.1.2 DVI operation

In DVI operation, all signals needed to operate the Automation Panel are transferred via a separate cable. The brightness of the display can be set using the brightness buttons.

#### 4.1.1.2.1 DVI operation with single-touch Automation Panel

If an Automation Panel with resistive touch screen (single-touch) is operated with DVI, a DVI, USB type A/B and RS232 cable must be connected.

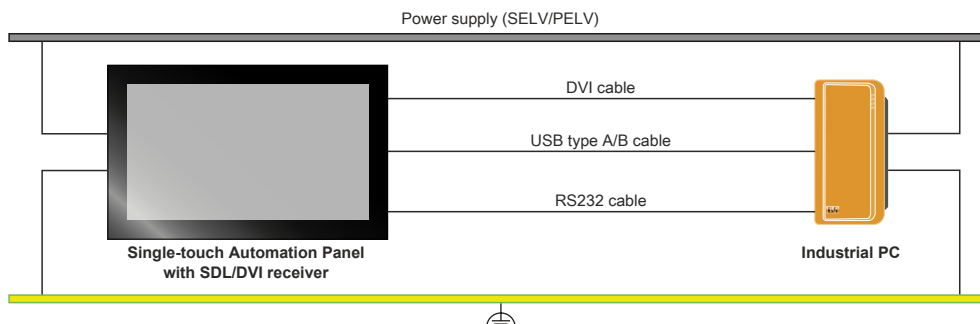

**Availability of the interfaces on the Automation Panel with SDL/DVI receiver:**

Panel In	✓	USB In	✓ USB 2.0	Power supply	✓	Brightness controls	✓
USB1, USB2	✓ USB 2.0	COM interface for touch screen	✓	Grounding	✓		

Maximum cable length: 5 m

**Requirements**

- Automation Panel with SDL/DVI receiver
- Industrial PC with DVI interface
- DVI cable, USB type A/B cable, RS232 cable

#### 4.1.1.2.2 DVI operation with multi-touch Automation Panel

If an Automation Panel with PCT touch screen (multi-touch) is operated with DVI, a DVI and USB type A/B cable must be connected.

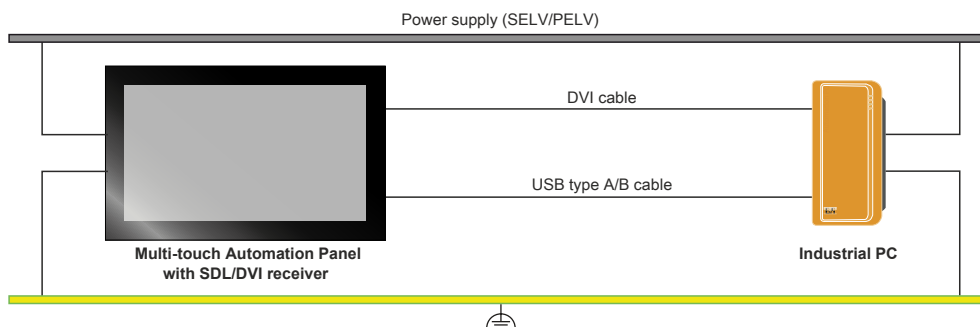

**Availability of the interfaces on the Automation Panel with SDL/DVI receiver:**

Panel In	✓	USB In	✓ USB 2.0	Power supply	✓	Brightness controls	✓
USB1, USB2	✓ USB 2.0	COM interface for touch screen	x	Grounding	✓		

Maximum cable length: 5 m

**Requirements**

- Automation Panel with SDL/DVI receiver
- Industrial PC with DVI interface
- DVI cable, USB type A/B cable

#### 4.1.1.2.3 General limitations

- Key and LED data is not transferred.
- Service and diagnostic data is not transferred.

- Updating the firmware of Automation Panels is not possible.
- The maximum cable length is limited to 5 m.

### 4.1.1.3 SDL4 operation

Smart Display Link 4 (SDL4) technology transfers all communication channels between a B&R industrial PC and panel up to 100 m over a standard Ethernet cable (min. Cat 6a). An RJ45 connector is used for the device connection, which is ideal for confined spaces in feed-throughs and swing arm systems.

#### 4.1.1.3.1 SDL4 operation with SDL4 transmitter

In SDL4 operation with an SDL4 transmitter in the B&R industrial PC, all communication between the Automation Panel and B&R industrial PC takes place via a single SDL4 cable.

In addition to the display data, information from the touch screen, matrix keys, LEDs and service/diagnostic data is transferred. The Automation Panel can be installed up to 100 m away from the B&R industrial PC. USB 2.0 is also transferred over this distance and fully integrated into SDL4. External adapter modules are not required.

The brightness of the display can be set via the ADI Control Center, for example.

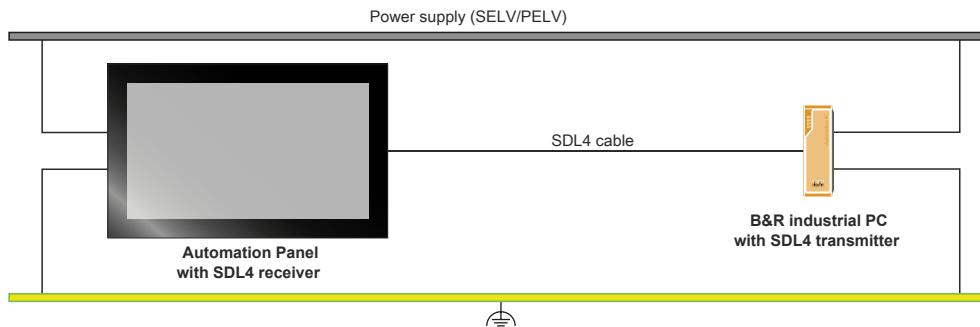

**Availability of the interfaces on the Automation Panel with SDL4 receiver:**

SDL4 interface ✓      USB1, USB2 ✓      USB 2.0      Power supply ✓      Grounding ✓

Maximum cable length for SDL4: 100 m

#### Requirements

- Automation Panel with SDL4 receiver
- B&R industrial PC with SDL4 interface
- SDL3/SDL4 cable

#### 4.1.1.3.2 General limitations

- USB 2.0 transfer is limited to 150 Mbit/s with SDL4.
- A display is always emulated by the SDL4 transmitter using EDID data and hot plug detection, so DVI-compatible operation is possible. For this reason, the following behavior may occur during operation with multiple displays.

In the operating system, a connected panel is reported by the video driver even in the following situations:

- No SDL3/SDL4 cable is connected.
- There is no connection established yet between the SDL4 link module and SDL4 transmitter.

This behavior can be avoided by appropriate configuration in BIOS or via the graphics driver.



### 4.1.2 Product information

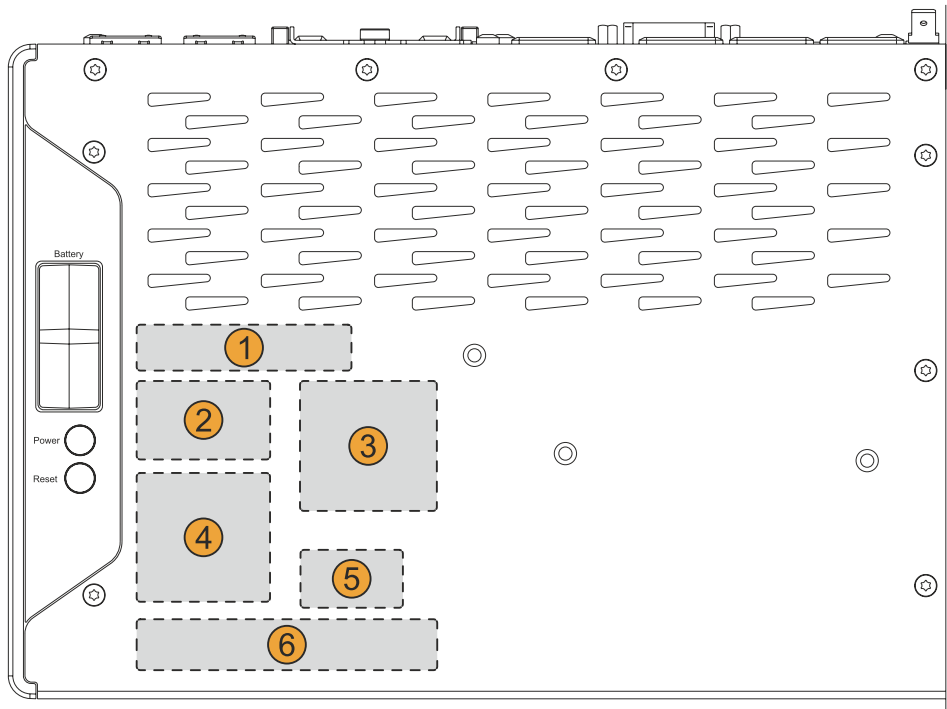

Position	Description
1	Specifications for the device family and electrical properties
2	Device-specific specifications, serial numbers and MAC addresses, see <a href="#">Identification</a> .
3	Valid test and conformity ID for the product, see section " <a href="#">Technical data</a> " on page 20
4	Safety notices, warnings and information about the product
5	License adhesive label for operating systems (configuration-dependent)
6	Space for individual customer information (configuration-dependent)

#### 4.1.2.1 Identification

Figure (symbolic)	Identification	
	1	Device number
	2	Serial number
	3	MAC addresses
		-

The device number can be retrieved from the B&R website ([www.br-automation.com](http://www.br-automation.com)) using the serial number of the device (login required). Information (serial number, material number, revision, delivery date and end of warranty) about all components installed in the system can be retrieved using the device number.

### 4.1.3 Mechanical properties

#### 4.1.3.1 Dimensions

##### Information:

All specifications in dimension diagrams and associated tables are in millimeters [mm].

2D and 3D diagrams (DXF and STEP formats) can be downloaded from the B&R website ([www.br-automation.com](http://www.br-automation.com)).

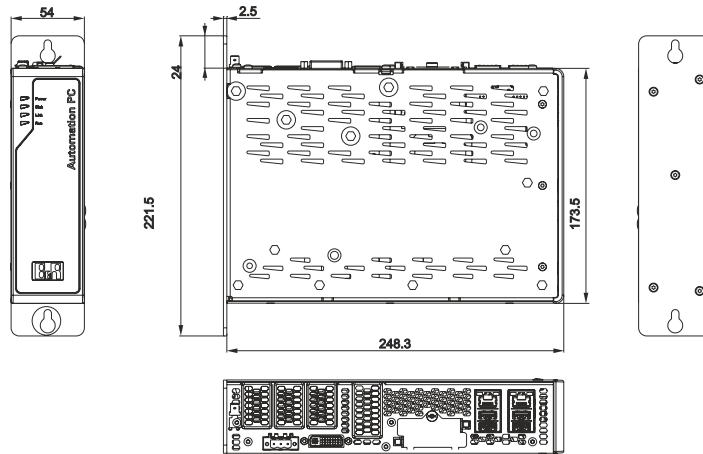

#### 4.1.3.2 Drilling template

##### Information:

When installing the Automation PC 3100, spacing for air circulation and additional free space for operating and servicing the device must be taken into account.

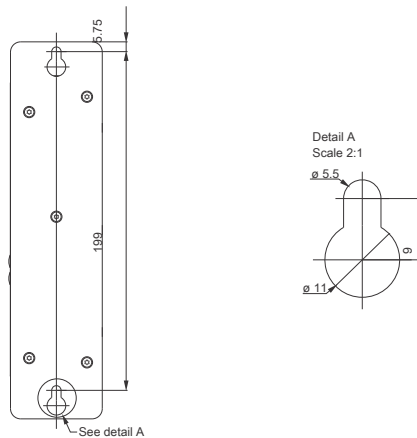

### 4.1.3.3 Spacing for air circulation

To ensure sufficient air circulation, a specified clearance must be provided above, below, to the side and behind the device. For the minimum specified clearance, see the following diagrams. This is valid for all variants.

#### Information:

The following figure and table exclusively show the thermal view of the complete system. If additional space is required for operating or servicing the device, this must be taken into account during installation.

The air inlet and air outlet are shown in the following figure.

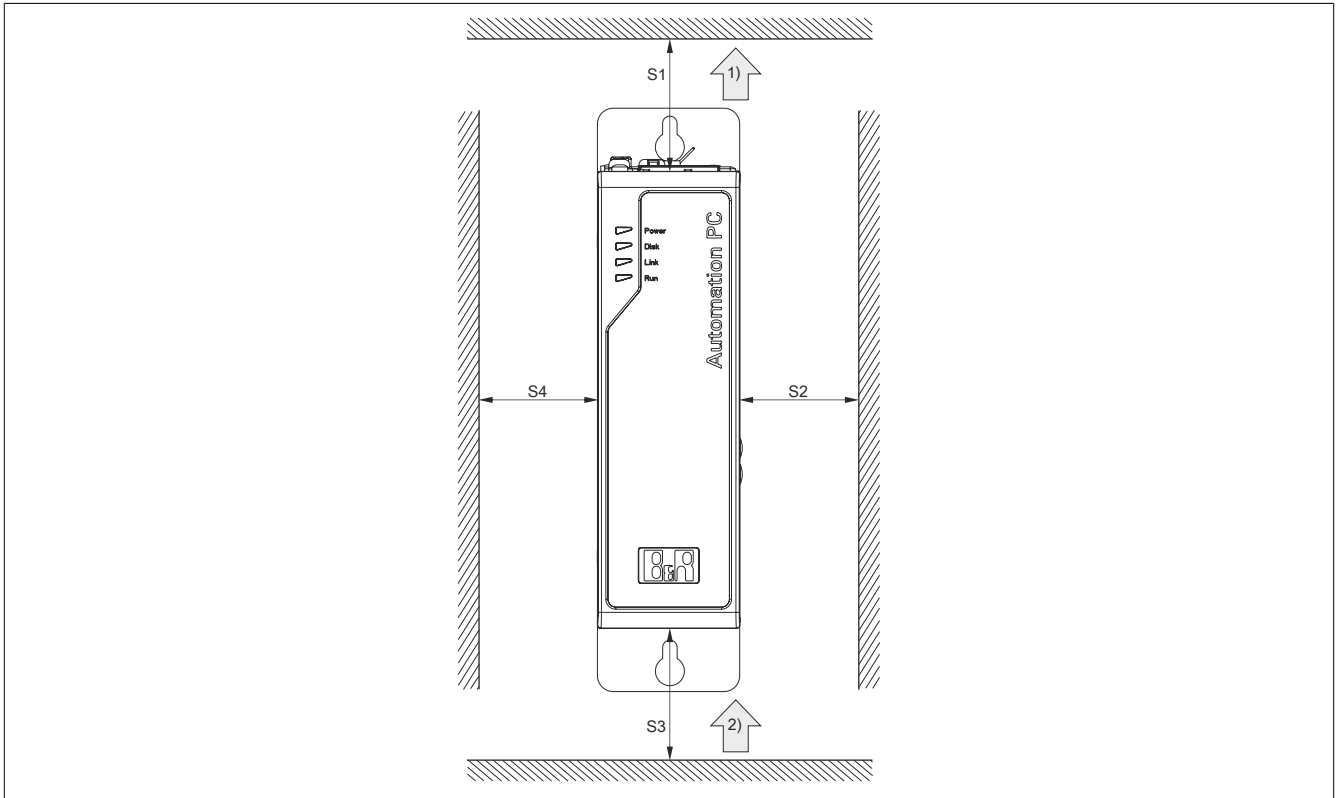

#### Legend

Name	Minimum spacing [mm]	Name	Minimum spacing [mm]
S1	≥ 100	S2	≥ 50
S3	≥ 100	S4	≥ 50

#### Caution!

The specified spacing for air circulation is based on worst-case operation at the maximum specified ambient temperature. The maximum specified ambient temperature is not permitted to be exceeded!

If the specified spacing for air circulation cannot be maintained, the maximum specified temperatures of the temperature sensors (see ["Temperature sensor positions" on page 34](#)) must be monitored in the application and appropriate measures taken if these values are exceeded.

### 4.1.3.4 Mounting orientations

During installation, it is important to make sure that the spacing as described in section "Spacing for air circulation" on page 27 is observed in order to achieve natural air circulation.

#### Rear mounting plate

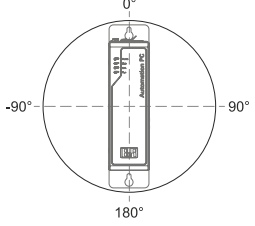
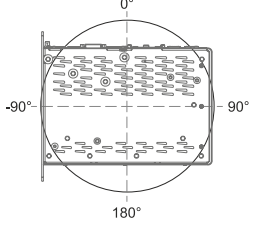
	Inclination [°]	Derating [°C]		Inclination [°]	Derating
	0 to ±5	No limitation		0 to ±5	No limitation
	±5 to ±175	-5		5 to 175	Not allowed!
	±175 to ±180	No limitation		-5 to -175	-5
				±175 to ±180	No limitation

### 4.1.3.5 Weight specifications

#### System units and components

Type	Order number	Weight [g]
System units	5APC3100.KBUx-000	1380
CFast cards	5CFAST.xxxx-00	10
	5CFAST.xxxx-10	10
Graphics options	5ACCLI02.DPO0-000	27
	5ACCLI02.SDLO-000	27
	5ACCLI02.SD40-000	38
Interface options	5AC901.I232-00	30
	5AC901.I485-00	34
	5AC901.ICAN-00	33
	5AC901.ICAN-01	33
	5AC901.IHDA-00	21
	5AC901.IRDY-00	30
	5AC901.IPLK-00	35
	5AC901.ISIO-00	30
	5AC901.ISRM-00	20
	5AC901.IETH-00	35
	5ACCIF02.CANE-000	100
	5ACCIF02.FPLK-000	100
	5ACCIF02.FPLS-000	100
	5ACCIF02.FPSC-000	100
	5ACCIF02.ISS0-000	100
	5ACCIF04.FPLK-000	100
	Mass storage options <sup>1)</sup>	5ACCMS01.MDT2-000

1) Without mass storage device.

## 4.1.4 Environmental properties

### 4.1.4.1 Temperature specifications

Because it is possible to combine different system units with a graphics option and interface option, the following tables provide a component-dependent overview of the maximum, minimum and typical possible ambient temperatures resulting from these combinations.

#### Information:

The minimum and maximum specified ambient temperatures were determined under worst-case conditions for operation. Experience has shown that higher ambient temperatures can be achieved with typical applications in Microsoft Windows, for example. The relevant test and assessment must be carried out individually by the user on site (reading out the temperatures in BIOS or using the ADI Control Center, for example).

#### Information about worst-case conditions

- Thermal Analysis Tool (TAT V5) from Intel for simulating processor utilization (100% CPU, 100% graphics , 100% memory)
- BurnInTest V7.1 Pro from PassMark Software for simulating 100% interface utilization using loopback adapters (100% network)
- 4x 1 A USB load
- Maximum expansion and power consumption of the system

#### 4.1.4.1.1 Maximum ambient temperature for worst-case operation

All temperature specifications in degrees Celsius [°C] at 500 m above sea level, <b>non-condensing</b> .		Maximum worst-case ambient temperature (system unit 5APC3100.KBUx-000)			
The respective ambient temperature is derated approx. 1°C per 1000 meters starting at 500 m above sea level.		5APC3100.KBU0-000 (C-3965U 2.2 GHz)	5APC3100.KBU1-000 (i3-7100U 2.4 GHz)	5APC3100.KBU2-000 (i5-7300U 2.6 GHz)	5APC3100.KBU3-000 (i7-7600U 2.8 GHz)
		60	55	50	50
<b>Maximum ambient temperature (accessories)</b>					
<b>CFast cards</b>	5CFAST.xxxx-00	✓	✓	✓	✓
	5CFAST.xxxx-10	✓	✓	✓	✓
<b>Graphics options</b>	5ACCLI02.DPO0-000	✓	✓	✓	✓
	5ACCLI02.SDL0-000	✓	✓	✓	✓
	5ACCLI02.SD40-000	55	✓	✓	✓
<b>Interface options</b>	5AC901.I232-000	✓	✓	✓	✓
	5AC901.I485-000	55	✓	✓	✓
	5AC901.ICAN-000	✓	✓	✓	✓
	5AC901.ICAN-001	✓	✓	✓	✓
	5AC901.IHDA-000	55	✓	✓	✓
	5AC901.IRDY-000	✓	✓	✓	✓
	5AC901.IPLK-000	55	✓	✓	✓
	5AC901.ISIO-000	✓	✓	✓	✓
	5AC901.ISRM-000	55	✓	✓	✓
	5AC901.IETH-000	55	✓	✓	✓
	5ACCIF02.CANE-000	55	✓	✓	✓
	5ACCIF02.FPLK-000	55	✓	✓	✓
	5ACCIF02.FPLS-000	55	✓	✓	✓
	5ACCIF02.FPSC-000	55	✓	✓	✓
	5ACCIF02.ISS0-000	✓	✓	✓	✓
5ACCIF04.FPLK-000	55	✓	✓	✓	
<b>Mass storage options<sup>1)</sup></b>	5ACCMS01.MDT2-000	55	✓	✓	✓

1) These values can be limited by the mass storage device used.

#### Information:

It may be necessary to limit the max. ambient temperature in certain applications (e.g. UL HazLoc) (for additional information, see "[International and national certifications](#)" on page 233).

#### 4.1.4.1.2 Minimum ambient temperature for worst-case operation

The minimum ambient temperature for non-condensing operation is 0°C.

### 4.1.4.1.3 Maximum ambient temperature for typical operation

#### Information about typical conditions

- BurnInTest V7.1 from PassMark Software for simulating moderate system and interface utilization using loopback adapters
- No permanent 100% processor utilization and graphics utilization
- 2x Gigabit Ethernet
- The total power of all USB interfaces on the system unit is limited to 4 W.
- The power consumption of the complete system is limited to 25 W. For the power consumption of individual components, see "Power calculation" on page 37.

All temperature specifications in degrees Celsius [°C] at 500 m above sea level, <b>non-condensing</b> .		Maximum ambient temperature for typical operation (system unit 5APC3100.KBUx-000)			
		5APC3100.KBU0-000 <sup>1)</sup> (C-3965U 2.2 GHz)	5APC3100.KBU1-000 <sup>1)</sup> (i3-7100U 2.4 GHz)	5APC3100.KBU2-000 <sup>2)</sup> (i5-7300U 2.6 GHz)	5APC3100.KBU3-000 <sup>2)</sup> (i7-7600U 2.8 GHz)
The maximum ambient temperature is typically derated 1°C per 1000 meters starting at 500 m above sea level.		60	60	55	55
<b>Maximum ambient temperature (accessories)</b>					
<b>CFAST cards</b>	5CFAST.xxxx-00	✓	✓	✓	✓
	5CFAST.xxxx-10	✓	✓	✓	✓
<b>Graphics options</b>	5ACCLI02.DPO0-000	✓	✓	✓	✓
	5ACCLI02.SDL0-000	✓	✓	✓	✓
	5ACCLI02.SD40-000	55	55	✓	✓
<b>Interface options</b>	5AC901.I232-000	✓	✓	✓	✓
	5AC901.I485-000	55	55	✓	✓
	5AC901.ICAN-000	✓	✓	✓	✓
	5AC901.ICAN-001	✓	✓	✓	✓
	5AC901.IHDA-000	55	55	✓	✓
	5AC901.IRDY-000	✓	✓	✓	✓
	5AC901.IPLK-000	55	55	✓	✓
	5AC901.ISIO-000	✓	✓	✓	✓
	5AC901.ISRM-000	55	55	✓	✓
	5AC901.IETH-000	55	55	✓	✓
	5ACCIF02.CANE-000	55	55	✓	✓
	5ACCIF02.FPLK-000	55	55	✓	✓
	5ACCIF02.FPLS-000	55	55	✓	✓
	5ACCIF02.FPSC-000	55	55	✓	✓
	5ACCIF02.ISS0-000	✓	✓	✓	✓
5ACCIF04.FPLK-000	55	55	✓	✓	
<b>Mass storage options<sup>3)</sup></b>	5ACCMS01.MDT2-000	55	55	✓	✓

- 1) Max. 15 W without USB
- 2) Max. 17 W without USB
- 3) These values can be limited by the mass storage device used.

#### 4.1.4.1.4 Determining the ambient temperature

1. Select the system unit.
2. The columns specify the maximum or minimum temperature in worst-case operation or the maximum temperature in typical operation of the complete system depending on the respective system unit.

#### **Information:**

**The maximum and typical temperature specifications correspond to a specification at 500 meters above sea level. The respective ambient temperature is derated approx. 1°C per 1000 meters starting at 500 m above sea level.**

3. If expansion options and CFast cards are additionally installed in the APC3100 system, they may result in a temperature limitation.
  - If a "✓" (check mark) is entered for the installed component, it can be operated without any problems.
  - If the installed component has a temperature specification (e.g. "45[°C]"), the ambient temperature of the complete system is not permitted to exceed this value.
4. Possible limitations may arise due to the mounting orientation of the APC3100. For additional information, see section "[Mounting orientations](#)" on page 28.
5. The relevant test and assessment must be carried out individually by the user on site (reading out the temperatures in BIOS or using the ADI Control Center). See section "[Information about typical conditions](#)" on page 31.



#### 4.1.4.1.5 Ambient temperature for storage and transport

The following table provides an overview of the minimum and maximum ambient temperatures for storing and transporting the complete system. Limitations are possible due to individual components.

##### System units and components

Type	Order number	Storage [°C]	Transport [°C]
System unit	5APC3100.KBUx-000	-20 to 60	-20 to 60
CFast card	5CFAST.xxxx-00	-50 to 100	-50 to 100
	5CFAST.xxxx-10	-40 to 85	-40 to 85
Graphics option	5ACCLI02.DPO0-000	-20 to 60	-20 to 60
	5ACCLI02.SDL0-000	-20 to 60	-20 to 60
	5ACCLI02.SD40-000	-20 to 60	-20 to 60
Interface option	5AC901.I232-00	-20 to 60	-20 to 60
	5AC901.I485-00	-20 to 60	-20 to 60
	5AC901.ICAN-00	-20 to 60	-20 to 60
	5AC901.ICAN-01	-20 to 60	-20 to 60
	5AC901.IHDA-00	-20 to 60	-20 to 60
	5AC901.IRDY-00	-20 to 60	-20 to 60
	5AC901.IPLK-00	-20 to 60	-20 to 60
	5AC901.ISIO-00	-20 to 60	-20 to 60
	5AC901.ISRM-00	-20 to 60	-20 to 60
	5AC901.IETH-00	-20 to 60	-20 to 60
	5ACCIF02.CANE-000	-20 to 60	-20 to 60
	5ACCIF02.FPLK-000	-20 to 60	-20 to 60
	5ACCIF02.FPLS-000	-20 to 60	-20 to 60
	5ACCIF02.FPSC-000	-20 to 60	-20 to 60
	5ACCIF02.ISS0-000	-20 to 60	-20 to 60
	5ACCIF04.FPLK-000	-20 to 60	-20 to 60
Mass storage option <sup>1)</sup>	5ACCMS01.MDT2-000	-20 to 60	-20 to 60

1) These values can be limited by the mass storage device used.

#### 4.1.4.1.6 Temperature monitoring

Sensors monitor temperature values at various areas in the APC3100. For the position of temperature sensors, see section "[Temperature sensor positions](#)" on page 34. The values specified there represent the defined maximum temperature at this measuring point. If the temperature is exceeded, no alarm is triggered.

Temperatures<sup>1)</sup> can be read out in different ways in approved operating systems:

- BIOS (see "[Baseboard](#)" on page 151)
- ADI Control Center
- ADI Development Kit
- ADI .NET SDK
- B&R HMI Service Center
- B&R HMI Report
- ADI OPC UA Server
- Automation Runtime library

The CFast cards available from B&R are equipped with S.M.A.R.T support<sup>2)</sup>. Various parameters (e.g. temperature) can be read out in approved Microsoft Windows or B&R Linux operating systems.

<sup>1)</sup> The measured temperature is a guide value for the immediate ambient temperature, but it may have been influenced by neighboring components.

<sup>2)</sup> Self-Monitoring, Analysis and Reporting Technology

### 4.1.4.1.7 Temperature sensor positions

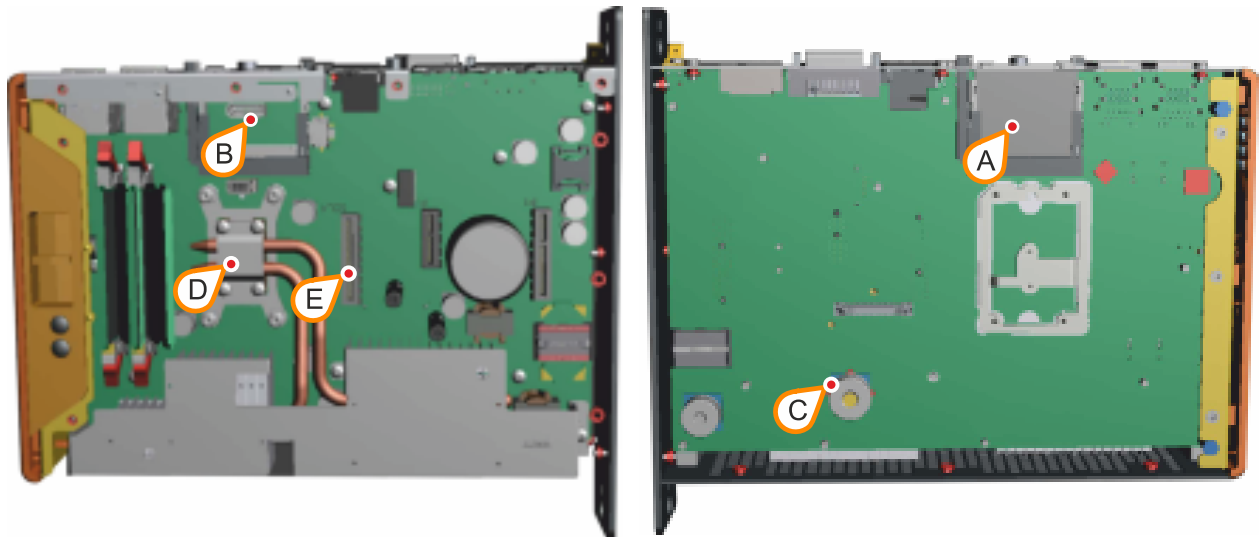

ADI sensors	Position	Measuring point for	Measurement	Max. specified
System unit sensor 1	A	CFast 2	Temperature of the CFast 2 area	90°C
System unit sensor 2	B	CFast 1	Temperature of the CFast 1 area	90°C
System unit sensor 3	C	MTCX	Temperature of the MTCX processor	90°C
System unit sensor 4	D	CPU	Temperature of the processor	95°C
IF option 3 slot	E	Graphics option	Temperature of a graphics option (sensor integrated on the graphics option)	Depends on the graphics option

#### 4.1.4.2 Relative humidity

The following tables show the minimum and maximum relative humidity (at 30°C, non-condensing) of the individual components that are relevant for limiting the humidity of the complete system. The smallest or largest value must always be used for this determination. For more detailed information, see technical data or temperature/humidity diagrams of the individual components.

Component	Order number	Operation [%]	Storage [%]	Transport [%]
System units	5APC3100.KBUx-000	5 to 90	5 to 95	5 to 95
CFast cards	5CFAST.xxxx-00	Max. 85% at 85°C	Max. 85% at 85°C	Max. 85% at 85°C
	5CFAST.xxxx-10	Max. 85% at 85°C	Max. 85% at 85°C	Max. 85% at 85°C
Graphics options	5ACCLI02.DPO0-000	5 to 90	5 to 95	5 to 95
	5ACCLI02.SDL0-000	5 to 90	5 to 95	5 to 95
	5ACCLI02.SD40-000	5 to 90	5 to 95	5 to 95
Interface options	5AC901.I232-00	5 to 90	5 to 95	5 to 95
	5AC901.I485-00	5 to 90	5 to 95	5 to 95
	5AC901.ICAN-00	5 to 90	5 to 95	5 to 95
	5AC901.ICAN-01	5 to 90	5 to 95	5 to 95
	5AC901.IHDA-00	5 to 90	5 to 95	5 to 95
	5AC901.IRDY-00	5 to 90	5 to 95	5 to 95
	5AC901.IPLK-00	5 to 90	5 to 95	5 to 95
	5AC901.ISIO-00	5 to 90	5 to 95	5 to 95
	5AC901.ISRM-00	5 to 90	5 to 95	5 to 95
	5AC901.IETH-00	5 to 90	5 to 95	5 to 95
	5ACCIF02.CANE-000	5 to 90	5 to 95	5 to 95
	5ACCIF02.FPLK-000	5 to 90	5 to 95	5 to 95
	5ACCIF02.FPLS-000	5 to 90	5 to 95	5 to 95
	5ACCIF02.FPSC-000	5 to 90	5 to 95	5 to 95
	5ACCIF02.ISS0-000	5 to 90	5 to 95	5 to 95
	5ACCIF04.FPLK-000	5 to 90	5 to 95	5 to 95
	Mass storage options <sup>1)</sup>	5ACCMS01.MDT2-000	5 to 90	5 to 95

1) These values can be limited by the mass storage device used.

#### 4.1.4.3 Vibration and shock

The following table provides an overview of the maximum vibrations and shock values of the complete system. Limitations are possible due to individual components.

Vibration				
Automation PC	Operation <sup>1)</sup>		Storage <sup>1)3)</sup>	Transport <sup>1)3)</sup>
With CFast card	Continuous 2 to 9 Hz: 1.75 mm amplitude 9 to 200 Hz: 0.5 g	Periodic 2 to 9 Hz: 3.5 mm amplitude 9 to 200 Hz: 1 g	2 to 8 Hz: 7.5 mm amplitude 8 to 200 Hz: 2 g 200 to 500 Hz: 4 g	2 to 8 Hz: 7.5 mm amplitude 8 to 200 Hz: 2 g 200 to 500 Hz: 4 g
Shock				
Automation PC	Operation <sup>2)</sup>		Storage <sup>2)3)</sup>	Transport <sup>2)3)</sup>
With CFast card	15 g, 11 ms		30 g, 6 ms	30 g, 6 ms

1) Testing is performed per EN 60068-2-6.

2) Testing is performed per EN 60068-2-27.

3) The specification refers to a device in its original packaging.

#### 4.1.4.4 Degree of protection

Under the following conditions, the Automation PC 3100 offers IP20 protection per EN 60529:

- Correct installation of the Automation PC 3100 (see "[Installation and wiring](#)" on page 128)
- Installation of all covers or components on interfaces and slots
- Compliance with all ambient conditions

### 4.1.5 Electrical properties

#### 4.1.5.1 System units - Block diagram

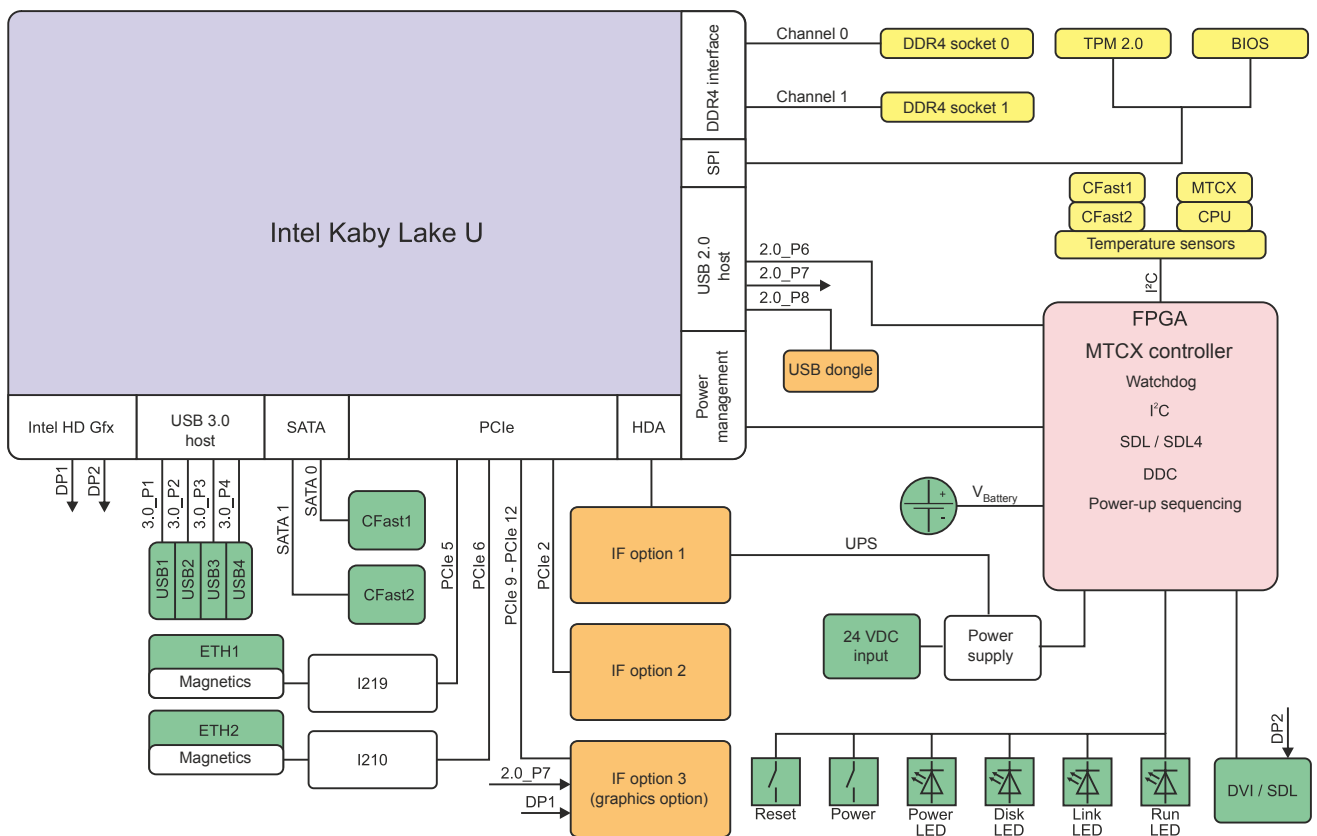

Legend			
<span style="background-color: yellow; border: 1px solid black; display: inline-block; width: 10px; height: 10px;"></span>	Internal interface	2.0_Px	USB 2.0 port x
<span style="background-color: lightgreen; border: 1px solid black; display: inline-block; width: 10px; height: 10px;"></span>	External interface	3.0_Px	USB 3.0 port x
<span style="background-color: orange; border: 1px solid black; display: inline-block; width: 10px; height: 10px;"></span>	Internal interface, removable/configurable		-

#### 4.1.5.2 Power calculation

In order to calculate the total power of the Automation PC 3100, the power ratings of the system unit used all other installed components must be added together.

### Information:

Unless otherwise stated, the following specified maximum values and additional consumers are not taken into account.

#### System units

Type	Order number	Total power consumption of the system unit
APC3100 C-3965U 2C 2.2 GHz	5APC3100.KBU0-000	Max. 19 W (without USB consumer) Max. 39 W (with USB consumer)
APC3100 i3-7100U 2C 2.4 GHz	5APC3100.KBU1-000	Max. 20 W (without USB consumer) Max. 40 W (with USB consumer)
APC3100 i5-7300U 2C 2.6 GHz	5APC3100.KBU2-000	Max. 23 W (without USB consumer) Max. 43 W (with USB consumer)
APC3100 i7-7600U 2C 2.8 GHz	5APC3100.KBU3-000	Max. 23 W (without USB consumer) Max. 43 W (with USB consumer)

#### Main memory

Type	Order number	Total power consumption
4 GB RAM	5MMDDR.4096-04	2.5 W
8 GB RAM	5MMDDR.8192-04	3.0 W
16 GB RAM	5MMDDR.016G-04	3.5 W

#### M.2 mass storage option

Type	Order number (adapter card)	Order number (M.2 SSD)	Total power consumption
M.2 mass storage option	5ACCMS01.MDT2-000	5ACCMSM2.0512-000	5.0 W
		5ACCMSM2.1024-000	5.0 W

### Information:

This information applies exclusively to the M.2 mass storage devices available from B&R. If third-party mass storage devices are used, refer to the manufacturer's documentation.

#### Graphics options

Type	Order number	+5 V	+3.3 V	+12 V	Total power consumption
DisplayPort transmitter	5ACCLI02.DPO0-000	2.7 W	0.3 W	-	3 W
SDL/DVI transmitter	5ACCLI02.SDL0-000	0.25 W	0.75 W	-	1 W
SDL4 transmitter	5ACCLI02.SD40-000	2.5 W	2 W	-	4.5 W

#### Interface options

Type	Order number	+5 V	+3.3 V	+12 V	Total power consumption
RS232 IF option	5AC901.I232-00	1 W	-	-	1 W
RS232/RS422/RS485 IF option	5AC901.I485-00	1 W	-	-	1 W
CAN IF option	5AC901.ICAN-00	1 W	-	-	1 W
CAN IF option	5AC901.ICAN-01	0.5 W	-	-	0.5 W
Audio IF option	5AC901.IHDA-00	0.2 W	0.2 W	-	0.4 W
Ready relay IF option	5AC901.IRDY-00	0.2 W	-	-	0.2 W
POWERLINK IF option	5AC901.IPLK-00	-	1.5 W	-	1.5 W
System I/O IF option	5AC901.ISIO-00	-	0.5 W	-	0.5 W
SRAM IF option	5AC901.ISRM-00	-	2 W	-	2 W
Gigabit Ethernet IF option	5AC901.IETH-00	-	1 W	-	1 W
Ethernet + CAN IF option	5ACCIF02.CANE-000	0.5 W	1 W	-	1.5 W
2x POWERLINK IF option	5ACCIF02.FPLK-000	-	2 W	-	2 W
SRAM POWERLINK RS232 IF option	5ACCIF02.FPLS-000	-	1.75 W	-	1.75 W
SRAM POWERLINK CAN X2X RS232 IF option	5ACCIF02.FPSC-000	0.6 W	1.4 W	-	2 W
2x RS232/RS422/RS485 IF option	5ACCIF02.ISS0-000	1.5 W	-	-	1.5 W
POWERLINK IF option	5ACCIF04.FPLK-000	-	1.5 W	-	1.5 W

**CFast cards**

Type	Order number	+5 V	+3.3 V	+12 V	Total power consumption
SLC technology	5CFAST.xxxx-00	-	0.7 W read 0.7 W write 0.3 W idle	-	0.7 W read 0.7 W write 0.3 W idle
MLC technology	5CFAST.032G-10 5CFAST.064G-10	-	1.1 W read 1 W write 0.25 W idle	-	1.1 W read 1 W write 0.25 W idle
	5CFAST.128G-10	-	1.1 W read 1.4 W write 0.25 W idle	-	1.1 W read 1.4 W write 0.25 W idle
	5CFAST.256G-10	-	1.2 W read 1.9 W write 0.25 W idle	-	1.2 W read 1.9 W write 0.25 W idle

**4.1.5.2.1 Calculation examples**

System unit 5APC3100.KBU1-000	40 W (with USB consumers)	40 W
Main memory module 5MMDDR.4096-04	2.5 W	2.5 W
Interface option 5AC901.ISRM-00	2 W	4 W
M.2 mass storage option 5ACCMSM0.MDT2-000 <sup>1)</sup>	5 W	5 W
CFast card 5CFAST.128G-10	1.4 W (write)	1.4 W
<b>Total max.:</b>		<b>52.9 W</b>

Table 3: Power calculation with example configuration 1

1) With M.2 SSD 5ACCMSM2.xxxx-000.

System unit 5APC3100.KBU3-000	43 W (with USB consumers)	43 W
2x main memory module 5MMDDR.016G-04	2x 3.5 W	7 W
Audio IF option 5AC901.IHDA-00	0.2 W + 0.2 W	0.4 W
Ethernet + CAN IF option 5ACCIF02.CANE-000	0.5 W + 1 W	1.5 W
Graphics option 5ACCLI01.SD40-000	2.5 W + 2 W	4.5 W
2x CFast card 5CFAST.256G-10	2x 1.9 W (write)	3.8 W
<b>Total max.:</b>		<b>60.2 W</b>

Table 4: Power calculation with example configuration 2

## 4.1.6 Device interfaces and slots

### 4.1.6.1 Device interface overview

#### Information:

The interfaces available on the device or module are numbered for the purpose of clear differentiation. The numbering used by the operating system may deviate, however.

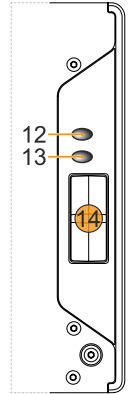
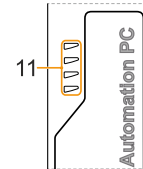
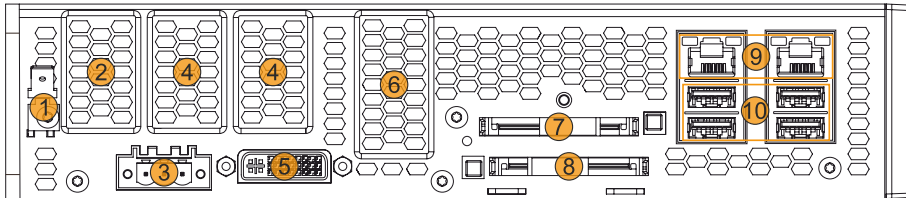

#### Legend

1	"Grounding" on page 40	8	"CFast slots" on page 43
2	"IF option 1 slot" on page 48	9	Ethernet interfaces
3	" +24 VDC power supply" on page 40	10	"USB interfaces" on page 42
4	"IF option 2 slot" on page 49	11	"LED status indicators" on page 44
5	"SDL/DVI-D interface" on page 46	12	"Power button" on page 43
6	"IF option 3 slot" on page 50	13	"Reset button" on page 43
7	"CFast slots" on page 43	14	"Battery" on page 45

### 4.1.6.2 +24 VDC power supply

#### Danger!

This device is only permitted to be supplied by a SELV/PELV power supply unit or with safety extra-low voltage (SELV) per IEC 61010-2-201.

The necessary 3-pin connector is not included in delivery; for suitable accessories, see "0TB103.9x" on page 229.

The device is protected against overload and reverse polarity by a soldered fuse (15 A, fast-acting). If the fuse is defective (e.g. due to overload), the device must be sent to B&R for repairs. If the polarity is reversed, it is not necessary to replace the fuse.

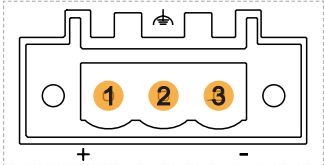
Pin	Description	Figure
1	+	
2	Functional ground	
3	-	
<ul style="list-style-type: none"> <li>Reverse polarity protection</li> <li>3-pin</li> <li>Male</li> </ul>		
Electrical properties		
Nominal voltage	24 VDC ±25%, SELV <sup>1)</sup>	
Nominal current	Max. 5.5 A	
Overtoltage category per EN 61131-2	II	
Inrush current	Max. 60 A for < 300 µs	
Galvanic isolation	Yes	
Uninterruptible power supply	No	

1) IEC 61010-2-201 requirements must be observed.

### 4.1.6.3 Grounding

#### Caution!

The functional ground (power supply pin 2 and ground connection) must be connected to the central grounding point (e.g. control cabinet or system) via the shortest possible path with the lowest possible resistance and with the largest possible wire cross section. This type of grounding is mandatory for proper functionality.

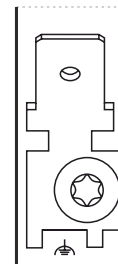

For example, a copper strip must be attached to the ground connection at a central grounding point of the control cabinet or system in which the device is installed. The wire cross section should be as large as possible (at least 2.5 mm<sup>2</sup>).



### 4.1.6.4 Ethernet interfaces

The Ethernet controllers are routed externally via the system unit.

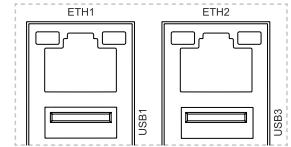

ETH1, ETH2		
Variant	RJ45, female	
Controller		
ETH1	Intel I219	
ETH2	Intel I210	
Wiring	S/STP (Cat 5e)	
Transfer rate	10/100/1000 Mbit/s <sup>1)</sup>	
Cable length	Max. 100 m (min. Cat 5e)	
<b>LED "Speed" (a)</b>	<b>On</b>	<b>Off</b>
Green	100 Mbit/s	10 Mbit/s <sup>2)</sup>
Orange (dark)	1000 Mbit/s	-
<b>LED "Link" (b)</b>	<b>On</b>	<b>Active</b>
Orange (light)	Link (a connection to an Ethernet network exists)	Blinking (data being transferred)

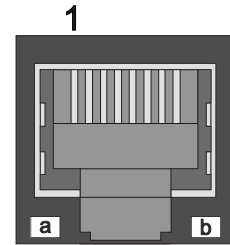

- 1) Switching takes place automatically.
- 2) The 10 Mbit/s transfer rate / connection is only available if LED "Link" is active at the same time.

A special driver is required to operate the Ethernet controller. Drivers for approved operating systems are available for download in the Downloads section of the B&R website ([www.br-automation.com](http://www.br-automation.com)).

#### Information:

**Necessary drivers must be downloaded from the B&R website, not from manufacturer websites.**

### 4.1.6.5 USB interfaces

APC3100 devices are equipped with a Universal Serial Bus 3.0 (USB 3.0) host controller with several USB ports. There are 4 USB 3.0 interfaces routed externally and freely available for the user. An additional USB 2.0 interface located inside the device.

#### Warning!

USB peripheral devices can be connected to the USB interfaces. Due to the variety of USB devices available on the market, B&R cannot guarantee their functionality. The functionality of USB devices available from B&R is ensured.

#### Caution!

Due to the general PC specification, this interface must be handled with the utmost care with regard to EMC, cable routing, etc.

USB1-4	
Standard	USB 3.0
Variant	Type A, female
Quantity	4
Transfer rate	Low speed (1.5 Mbit/s)
	Full speed (12 Mbit/s)
	High speed (480 Mbit/s)
	SuperSpeed (5 Gbit/s)
Current-carrying capacity <sup>1)</sup>	Max. 1 A per connection
Cable length	USB 2.0
	USB 3.0
	Max. 5 m (without hub)
	Max. 3 m (without hub)
	-

1) Each USB interface is protected by a maintenance-free "USB current-limiting switch" (max. 1 A).

A USB 2.0 interface is available internally for the Technology Guard. The system unit must be opened for replacement or retrofitting.

USB5	
Standard	USB 2.0
Variant	Type A, female
Transfer rate	Low speed (1.5 Mbit/s)
	Full speed (12 Mbit/s)
	High speed (480 Mbit/s)
Current-carrying capacity <sup>1)</sup>	Max. 0.5 A
Cable length	Internal for Technology Guard
	-

1) The USB interface is protected by a maintenance-free "USB current-limiting switch" (max. 0.5 A).

#### 4.1.6.6 CFAST slots

The Automation PC offers easily accessible CFAST slots so that the CFAST card can also be used as a removable storage medium for data transfer or upgrades.

The CFAST slots are internally connected to the chipset and implemented in version SATA III (SATA 6.0 Gbit/s).

### Warning!

**CFAST cards are only permitted to be connected and disconnected in a voltage-free state!**

CFAST slots 1-2	
<b>Connection</b>	
CFAST slot 1	SATA 0
CFAST slot 2	SATA 1
<b>Order number</b>	<b>Short description</b>
<b>CFAST cards</b>	
5CFAST.2048-00	CFAST 2 GB SLC
5CFAST.4096-00	CFAST 4 GB SLC
5CFAST.8192-00	CFAST 8 GB SLC
5CFAST.016G-00	CFAST 16 GB SLC
5CFAST.032G-00	CFAST 32 GB SLC
5CFAST.032G-10	CFAST 32 GB MLC
5CFAST.064G-10	CFAST 64 GB MLC
5CFAST.128G-10	CFAST 128 GB MLC
5CFAST.256G-10	CFAST 256 GB MLC

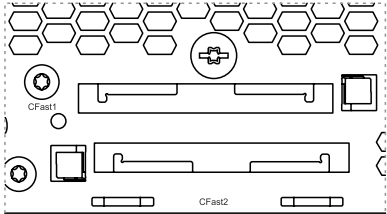

#### 4.1.6.7 Power and reset buttons

Both buttons can be pressed without any tools.



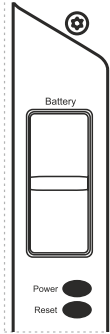







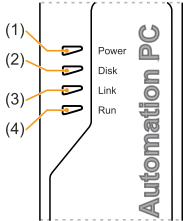





Description
<p><b>Power button</b></p> <p>The power button offers full ATX power supply unit support and has various configurable functions.</p> <ul style="list-style-type: none"> <li>• <b>Short press:</b> Switches the PC on or off or performs the action configured in the operating system when pressing the power button (shutdown, sleep, etc.).</li> <li>• <b>Long press (approx. 4 s):</b> The ATX power supply unit switches off the PC without shutting it down.</li> </ul> <p>Pressing the power button does not reset the MTCX processor.</p>
<p><b>Reset button</b></p> <p>Pressing the reset button triggers a hardware/PCI reset. The PC is restarted. During a reset, the MTCX processor is not reset.</p>



### Warning!

**Switching off the power without shutting down or resetting the system can result in data loss!**

4.1.6.8 LED status indicators

Assignment	LED	Color	Status	Explanation	LED status indicator <sup>1)</sup>	
	(1): <b>Power</b>	Green	On	Power supply OK		
			Blinking	The device is started up; the battery state is BAD.		
		<p><b>Information:</b></p> <p>For additional information, see "Battery" on page 45.</p>				
		Red	On	The system is in power saving mode (standby). <sup>1)</sup>		
			Blinking	The MTCX is running; the battery state is "BAD". The system is in power saving mode (standby). <sup>1)</sup>		
		Red-Green	Blinking	Faulty or incomplete BIOS, MTCX or I/O FPGA update, battery state OK, power supply OK		
	Faulty or incomplete BIOS, MTCX or I/O FPGA update, battery state OK, power saving mode (standby) <sup>1)</sup>					
	Faulty or incomplete BIOS, MTCX or I/O FPGA update, battery state BAD, power supply OK					
	Faulty or incomplete BIOS, MTCX or I/O FPGA update, battery state BAD, power saving mode (standby) <sup>1)</sup>					
	<p><b>Information:</b></p> <p>An update must be performed again.</p>					
	(2): <b>Disk</b>	Yellow	On	Power supply not OK. The system is running in UPS mode.		
			On	Indicates drive access (HDD, SSD, CFast)		
	(3): <b>Link</b>	Yellow	On	Indicates an active SDL connection on the panel connector.		
			Blinking	An active SDL connection was interrupted due to power loss of the panel.		
	<p><b>Information:</b></p> <p>Check the power supply or power connection of the connected panel.</p>					
	(4): <b>Run</b>	Green	Blinking	Automation Runtime is starting up. Controlled by Automation Runtime (ARemb and AR-win).		
On			Application running. Controlled by Automation Runtime (ARemb and AR-win).			
On			Application in SERVICE mode. Controlled by Automation Runtime (ARemb and AR-win).			
Blinking			A license violation has occurred.			

1) Two columns form 1 interval of 500 ms each.  
 2) S5: Soft-off  
 S4: Hibernate (suspend-to-disk)

### 4.1.6.9 Battery

The lithium battery (3 V, 950 mAh) ensures retention of the internal real-time clock (RTC). It is located above the power and reset button behind the orange cover. The self-discharge time of the battery is at least 4 years.<sup>1)</sup> The battery is subject to wear and should be replaced regularly (at least after the specified service life) by changing the battery (see ["Changing the battery" on page 217](#)).

Battery	
Type	Renata 3 V, 950 mAh
Removable	Yes, accessible from the outside
Service life	4 years <sup>1)</sup>
<b>Order number</b>	<b>Short description</b>
	<b>Batteries</b>
0AC201.91	Lithium batteries, 4 pcs., 3 V / 950 mAh, button cell
4A0006.00-000	Lithium battery, 1 pc., 3 V / 950 mAh, button cell

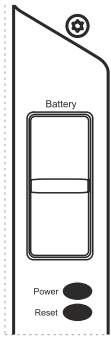

1) At 50°C, 8.5 µA for the components being supplied and self-discharge of 40%. If an interface option with SRAM or POWERLINK is installed, the service life is 2½ years.

The battery state is determined by the system immediately after the device is switched on and subsequently every 24 hours. During the measurement, the battery is subjected to a brief load (approx. 1 second) and then assessed. The determined battery state is displayed on the BIOS Setup screens (Advanced - OEM features - ["Baseboard" on page 151](#)) and in the ADI Control Center but can also be read out in a customer application via the ADI library.

Battery state	Explanation
N/A	The hardware or firmware used is too old and does not support readout.
GOOD	Data retention is ensured.
BAD	As soon as the battery capacity is recognized as BAD (insufficient), retention of data is ensured for approximately another 500 hours. The battery must be replaced.

When changing the battery, data is retained for approximately 10 minutes by a gold foil capacitor.

#### 4.1.6.10 SDL/DVI-D interface

The interface is designed as a DVI-I connector (female) and can be operated with DVI-D or SDL transmission technology.

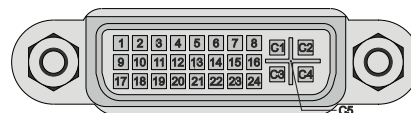

Pin	Pinout	Description	Pin	Pinout	Description
1	TMDS data 2-	DVI lane 2 (negative)	16	HPD	Hot plug detection
2	TMDS data 2+	DVI lane 2 (positive)	17	TMDS data 0-	DVI lane 0 (negative)
3	TMDS data 2/4 SHIELD	Shield for data pairs 2 and 4	18	TMDS data 0+	DVI lane 0 (positive)
4	SDL-	SDL lane (negative)	19	TMDS data 0/XUSB1 SHIELD	Shield of data pair 0 and USB1
5	SDL+	SDL lane (positive)	20	XUSB1-	USB lane 1 (negative)
6	DDC clock	DDC-based control signal (clock)	21	XUSB1+	USB lane 1 (positive)
7	DDC data	DDC-based control signal (data)	22	TMDS clock shield	Shield of clock pair
8	Not connected	Not connected	23	TMDS clock+	DVI clock (positive)
9	TMDS data 1-	DVI lane 1 (negative)	24	TMDS clock -	DVI clock (negative)
10	TMDS data 1+	DVI lane 1 (positive)	C1	Not connected	Not connected
11	TMDS data 1/XUSB0 SHIELD	Shield of data pair 1 and USB0	C2	Not connected	Not connected
12	XUSB0-	USB lane 0 (negative)	C3	Not connected	Not connected
13	XUSB0+	USB lane 0 (positive)	C4	Not connected	Not connected
14	+5 V power <sup>1)</sup>	+5 V power supply	C5	Not connected	Not connected
15	Ground (return for +5 V, HSync and VSync)	Ground	-		-

1) Protected internally by a multifuse.

#### Information:

Hot plugging output devices on the interface for service purposes is supported by the hardware and graphic drivers of approved operating systems. Recalibration may be required for touch screen devices.

A maximum of 100 mating cycles are specified for this interface.

#### Information:

In SDL operation without USB type A/B cable, the USB transfer rate is limited to USB 1.1.

A USB transfer rate of USB 2.0 is possible in DVI or SDL operation with a USB type A/B cable.

#### 4.1.6.10.1 Cable lengths and resolutions for SDL transfer

The following table shows the relationship between segment length and maximum resolution depending on the SDL cable:

SDL cable Segment length [m]	Resolution						
	VGA 640 x 480	SVGA 800 x 600	XGA 1024 x 768	HD 1366 x 768	SXGA 1280 x 1024	UXGA 1600 x 1200	FHD 1920 x 1080
0.8	5CASDL.0008-00	5CASDL.0008-00	5CASDL.0008-00	5CASDL.0008-00	5CASDL.0008-00	5CASDL.0008-00	5CASDL.0008-00
1.8	5CASDL.0018-00	5CASDL.0018-00	5CASDL.0018-00	5CASDL.0018-00	5CASDL.0018-00	5CASDL.0018-00	5CASDL.0018-00
	5CASDL.0018-01	5CASDL.0018-01	5CASDL.0018-01	5CASDL.0018-01	5CASDL.0018-01	5CASDL.0018-01	5CASDL.0018-01
	5CASDL.0018-03	5CASDL.0018-03	5CASDL.0018-03	5CASDL.0018-03	5CASDL.0018-03	5CASDL.0018-03	5CASDL.0018-03
5	5CASDL.0050-00	5CASDL.0050-00	5CASDL.0050-00	5CASDL.0050-00	5CASDL.0050-00	5CASDL.0050-00	5CASDL.0050-00
	5CASDL.0050-01	5CASDL.0050-01	5CASDL.0050-01	5CASDL.0050-01	5CASDL.0050-01	5CASDL.0050-01	5CASDL.0050-01
	5CASDL.0050-03	5CASDL.0050-03	5CASDL.0050-03	5CASDL.0050-03	5CASDL.0050-03	5CASDL.0050-03	5CASDL.0050-03
6	5CASDL.0060-00	5CASDL.0060-00	5CASDL.0060-00	5CASDL.0060-00	5CASDL.0060-00	5CASDL.0060-00	5CASDL.0060-00
10	5CASDL.0100-00	5CASDL.0100-00	5CASDL.0100-00	5CASDL.0100-00	5CASDL.0100-00	5CASDL.0100-00	5CASDL.0100-00
	5CASDL.0100-01	5CASDL.0100-01	5CASDL.0100-01	5CASDL.0100-01	5CASDL.0100-01	5CASDL.0100-01	5CASDL.0100-01
	5CASDL.0100-03	5CASDL.0100-03	5CASDL.0100-03	5CASDL.0100-03	5CASDL.0100-03	5CASDL.0100-03	5CASDL.0100-03
15	5CASDL.0150-00	5CASDL.0150-00	5CASDL.0150-00	5CASDL.0150-00	5CASDL.0150-00	-	-
	5CASDL.0150-01	5CASDL.0150-01	5CASDL.0150-01	5CASDL.0150-01	5CASDL.0150-01	-	-
	5CASDL.0150-03	5CASDL.0150-03	5CASDL.0150-03	5CASDL.0150-03	5CASDL.0150-03	-	5CASDL.0150-03
20	5CASDL.0200-00	5CASDL.0200-00	5CASDL.0200-00	5CASDL.0200-00	5CASDL.0200-00	-	-
	5CASDL.0200-03	5CASDL.0200-03	5CASDL.0200-03	5CASDL.0200-03	5CASDL.0200-03	-	5CASDL.0200-03
25	5CASDL.0250-00	5CASDL.0250-00	5CASDL.0250-00	5CASDL.0250-00	-	-	-
	5CASDL.0250-03	5CASDL.0250-03	5CASDL.0250-03	5CASDL.0250-03	-	-	-
30	5CASDL.0300-00	5CASDL.0300-00	-	-	-	-	-
	5CASDL.0300-03	5CASDL.0300-03	5CASDL.0300-13	5CASDL.0300-13	5CASDL.0300-13	-	5CASDL.0300-13
40	5CASDL.0400-13	5CASDL.0400-13	5CASDL.0400-13	5CASDL.0400-13	5CASDL.0400-13	-	5CASDL.0400-13

#### 4.1.6.10.2 Cable lengths and resolutions for DVI transfer

The following table shows the relationship between segment length and maximum resolution depending on the DVI cable:

DVI cable Segment length [m]	Resolution						
	VGA 640 x 480	SVGA 800 x 600	XGA 1024 x 768	HD 1366 x 768	SXGA 1280 x 1024	UXGA 1600 x 1200	FHD 1920 x 1080
1.8	5CADVI.0018-00	5CADVI.0018-00	5CADVI.0018-00	5CADVI.0018-00	5CADVI.0018-00	5CADVI.0018-00	5CADVI.0018-00
5	5CADVI.0050-00	5CADVI.0050-00	5CADVI.0050-00	5CADVI.0050-00	5CADVI.0050-00	5CADVI.0050-00	5CADVI.0050-00

The maximum cable length for DVI transfer is limited to 5 m due to the USB specification.

#### 4.1.6.11 IF option 1 slot

Automation PC 3100 system units have 3 slots for interface options.

The following table lists the interface options that can be used in the IF option 1 slot.

IF option 1 slot	
Order number	Interface option - Short description
5AC901.I232-00 <sup>1)</sup>	Interface card - 1x RS232 - For APC910/PPC900/APC3100/PPC3100
5AC901.I485-00 <sup>1)</sup>	Interface card - 1x RS232/RS422/RS485 interface - For APC910/PPC900/APC3100/PPC3100
5AC901.ICAN-00 <sup>2)</sup>	Interface card - 1x CAN interface - For APC910/PPC900/APC3100/PPC3100
5AC901.ICAN-01 <sup>2)</sup>	Interface card - 1x CAN interface - For APC910/PPC900/APC3100/PPC3100
5AC901.IHDA-00	Interface card - 1x audio interface (1x MIC / 1x Line In / 1x OUT) - For APC910/PPC900/APC3100/PPC3100
5AC901.IRDY-00	Interface card - Ready relay - For APC910/PPC900/APC3100/PPC3100
5AC901.ISIO-00	Interface card - System I/O - For APC910/PPC900/APC3100/PPC3100
5AC901.IUPS-00 <sup>3)</sup>	UPS - For 4.5 Ah battery
5AC901.IUPS-01 <sup>4)</sup>	UPS - For 2.2 Ah battery

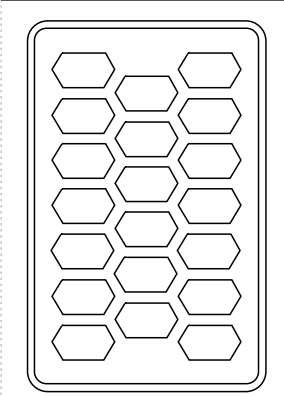

IF1

- 1) Simultaneous operation with 5ACCIF02.ISS0-000 in the IF option 2 slot is not possible.
- 2) Simultaneous operation of 2 interface options with a legacy CAN interface in slots IF1 and IF2 is not possible.
- 3) UPS IF option 5AC901.IUPS-00 is only permitted to be operated with battery unit 5AC901.BUPS-00!
- 4) UPS IF option 5AC901.IUPS-01 is only permitted to be operated with battery unit 5AC901.BUPS-01!

### Information:

For information about replacing or installing an interface option, see section "Installing the interface option and DDR4 SDRAM" on page 220.



### 4.1.6.12 IF option 2 slot

Automation PC 3100 system units have 3 slots for interface options.

The following table lists the interface options that can be used in the IF option 2 slot.

IF option 2 slot	
Order number	Interface option - Short description
5AC901.I232-00	Interface card - 1x RS232 interface - For APC910/PPC900/APC3100/PPC3100
5AC901.I485-00	Interface card - 1x RS232/RS422/RS485 interface - For APC910/PPC900/APC3100/PPC3100
5AC901.ICAN-00 <sup>1)</sup>	Interface card - 1x CAN interface - For APC910/PPC900/APC3100/PPC3100
5AC901.ICAN-01 <sup>1)</sup>	Interface card - 1x CAN interface - For APC910/PPC900/APC3100/PPC3100
5AC901.IETH-00	Interface card - 1x Ethernet 10/100/1000 - For APC910/PPC900/APC3100/PPC3100
5AC901.IPLK-00	Interface card - 1x POWERLINK interface - 2 MB SRAM - For APC910/PPC900/APC3100/PPC3100
5AC901.ISRM-00	Interface card - 2 MB RAM - For APC910/PPC900/APC3100/PPC3100
5AC901.IRDY-00	Interface card - Ready relay - For APC910/PPC900/APC3100/PPC3100
5AC901.ISIO-00	Interface card - System I/O - For APC910/PPC900/APC3100/PPC3100
5ACCIF02.CANE-000 <sup>1)2)</sup>	Interface card - 1x CAN interface (SJA1000) - 1x ETH 10/100/1000 - For APC3100/PPC3100
5ACCIF02.FPLK-000 <sup>2)</sup>	Interface card - 1x POWERLINK interface - 2 MB SRAM - Integrated 2-port hub - Ring redundancy - POWERLINK managing or controlled node - PRC function - For APC3100/PPC3100
5ACCIF02.FPLS-000 <sup>2)</sup>	Interface card - 2 MB SRAM - 1x RS232 interface - 1x POWERLINK interface - For APC3100/PPC3100
5ACCIF02.FPSC-000 <sup>2)</sup>	Interface card - 2 MB SRAM - 1x RS232 interface - 1x CAN interface - 1x POWERLINK interface - 1x X2X - For APC3100/PPC3100
5ACCIF02.ISS0-000 <sup>2)3)</sup>	Interface card - 2x RS232/RS422/RS485 interface - For APC3100/PPC3100

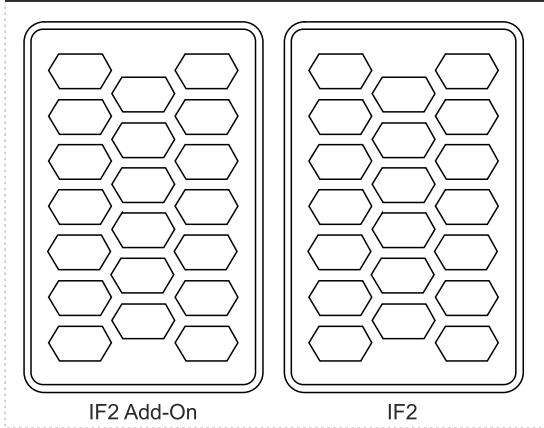

- 1) Simultaneous operation of 2 interface options with a legacy CAN interface in slots IF1 and IF2 is not possible.
- 2) These IF options use the IF option 2 and IF option 2 add-on slot.
- 3) Simultaneous operation with 5AC901.I232-00 or 5AC901.I485-00 in the IF option 1 slot is not possible.

### Information:

For information about replacing or installing an interface option, see section "Installing the interface option and DDR4 SDRAM" on page 220.

### 4.1.6.13 IF option 3 slot

Automation PC 3100 system units have 3 slots for interface options.

The following table lists the interface options that can be used in the IF option 3 slot.

IF option 3 slot	
Order number	Graphics option - Short description
5ACCLI02.DPO0-000	Graphics option - 1x DisplayPort transmitter (version 1.2) - For APC3100/PPC3100
5ACCLI02.SDL0-000	Graphics option - 1x SDL/DVI transmitter - For APC3100/ PPC3100
5ACCLI02.SD40-000	Graphics option - 1x SDL4 transmitter (max. 1920 x 1080) - For APC3100/PPC3100
Order number	Interface option - Short description
5ACCIF04.FPLK-000	Interface card - 1x POWERLINK interface - For APC3100/ PPC3100
Order number	Mass storage option - Short description
5ACCMS01.MDT2-000	Adapter card for M.2 mass storage device - For APC3100/ PPC3100

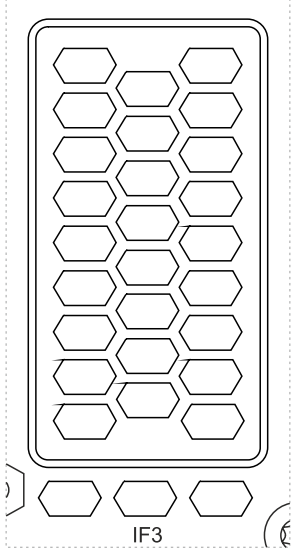

#### Information:

For information about replacing or installing an interface option, see section ["Installing the interface option and DDR4 SDRAM"](#) on page 220.

#### 4.1.6.14 Trusted Platform Module (TPM)

A Trusted Platform Module (TPM 2.0) is located on the system unit. A TPM is an additional chip integrated directly into the system hardware that adds important safety functions to the device. In particular, the TPM enables improved protection of the PC against unauthorized tampering by third parties. These safety functions are supported by current operating systems, such as Windows 10.

##### Enabling the Trusted Platform Module

The TPM is disabled by default and can be enabled in BIOS menu "Setup utility" under "Security". In addition, parameter "Platform Trust Technology" must be disabled under "Advanced - Chipset configuration". Follow the instructions in BIOS Setup.

##### **Information:**

**Before enabling the TPM, possible country-specific usage restrictions or regulations must be checked.**

##### Using the Trusted Platform Module

The TPM can be used together with the drive encryption *BitLocker* in Windows 10, for example. To do this, follow the instructions in the operating system.

##### **Information:**

**If the password for data encryption is lost, it is not possible to decrypt the data, e.g. after a BIOS update or TPM firmware update. Access to the encrypted drive is lost. Passwords must be carefully stored and protected from unauthorized access.**

## 4.2 Individual components

### 4.2.1 System units

#### 4.2.1.1 5APC3100.KBUx-000

##### 4.2.1.1.1 General information

APC3100 system units consist of a CPU board, housing and mounting plate. Several interfaces are included, and 3 interface options can be additionally installed. The main memory can be replaced or expanded.

- Intel Core i-series processors
- DDR4 memory
- Intel HD Graphics
- 2 CFast slots
- Slots for 3 interface options
- Replaceable and expandable main memory

4.2.1.1.2 Order data

Order number	Short description	Figure
	<b>System units</b>	
5APC3100.KBU0-000	APC3100 system unit - Intel Celeron 3965U 2.2 GHz - Dual core	
5APC3100.KBU1-000	APC3100 system unit - Intel Core i3 7100U 2.4 GHz - Dual core	
5APC3100.KBU2-000	APC3100 system unit - Intel Core i5 7300U 2.6 GHz - Dual core	
5APC3100.KBU3-000	APC3100 system unit - Intel Core i7 7600U 2.8 GHz - Dual core	
	<b>Required accessories</b>	
	<b>CFAST cards</b>	
5CFAST.016G-00	CFAST 16 GB SLC	
5CFAST.032G-00	CFAST 32 GB SLC	
5CFAST.032G-10	CFAST 32 GB MLC	
5CFAST.064G-10	CFAST 64 GB MLC	
5CFAST.128G-10	CFAST 128 GB MLC	
5CFAST.2048-00	CFAST 2 GB SLC	
5CFAST.256G-10	CFAST 256 GB MLC	
5CFAST.4096-00	CFAST 4 GB SLC	
5CFAST.8192-00	CFAST 8 GB SLC	
	<b>Optional accessories</b>	
	<b>Graphics options</b>	
5ACCLI02.DPO0-000	Graphics option - 1x DisplayPort transmitter (version 1.2) - For APC3100/PPC3100	
5ACCLI02.SD40-000	Graphics option - 1x SDL4 transmitter (max. 1920 x 1080) - For APC3100/PPC3100	
5ACCLI02.SDL0-000	Graphics option - 1x SDL/DVI transmitter - For APC3100/PPC3100	
	<b>Interface options</b>	
5AC901.I232-00	Interface card - 1x RS232 interface - For APC910/PPC900/APC3100/PPC3100	
5AC901.I485-00	Interface card - 1x RS232/RS422/RS485 interface - For APC910/PPC900/APC3100/PPC3100	
5AC901.ICAN-00	Interface card - 1x CAN interface - For APC910/PPC900/APC3100/PPC3100	
5AC901.ICAN-01	Interface card - 1x CAN interface (SJA1000) - For APC910/PPC900/APC3100/PPC3100	
5AC901.IETH-00	Interface card - 1x ETH 10/100/1000 - For APC910/PPC900/APC3100/PPC3100	
5AC901.IHDA-00	Interface card - 1x audio interface (1x MIC / 1x Line In / 1x OUT) - For APC910/PPC900/APC3100/PPC3100	
5AC901.IPLK-00	Interface card - 1x POWERLINK interface - 2 MB SRAM - For APC910/PPC900/APC3100/PPC3100	
5AC901.IRDY-00	Interface card - Ready relay - For APC910/PPC900/APC3100/PPC3100	
5AC901.ISIO-00	Interface card - System I/O - For APC910/PPC900/APC3100/PPC3100	
5AC901.ISRM-00	Interface card - 2 MB SRAM - For APC910/PPC900/APC3100/PPC3100	
5ACCIF02.CANE-000	Interface card - 1x CAN interface (SJA1000) - 1x ETH 10/100/1000 - For APC3100/PPC3100	
5ACCIF02.FPLK-000	Interface card - 1x POWERLINK interface - 2 MB SRAM - Integrated 2-port hub - Ring redundancy - POWERLINK managing or controlled node - PRC function - For APC3100/PPC3100	
5ACCIF02.FPLS-000	Interface card - 2 MB SRAM - 1x RS232 interface - 1x POWERLINK interface - For APC3100/PPC3100	
5ACCIF02.FPSC-000	Interface card - 2 MB SRAM - 1x RS232 interface - 1x CAN interface - 1x POWERLINK interface - 1x X2X - For APC3100/PPC3100	
5ACCIF02.ISS0-000	Interface card - 2x RS232/RS422/RS485 interface - For APC3100/PPC3100	
5ACCIF04.FPLK-000	Interface card - 1x POWERLINK interface - For APC3100/PPC3100	
	<b>Main memory</b>	
5MMDDR.016G-04	SO-DIMM DDR4, 16384 MB	
5MMDDR.016G-K01	TZL SO-DIMM DDR4-2133 16384 MB	
5MMDDR.4096-04	SO-DIMM DDR4, 4096 MB	
5MMDDR.8192-04	SO-DIMM DDR4, 8192 MB	
	<b>Mass storage options</b>	
5ACCMS01.MDT2-000	Adapter card for M.2 mass storage device - For APC3100/PPC3100	
	<b>Uninterruptible power supply</b>	
5AC901.IUPS-00	UPS - For 4.5 Ah battery	
5AC901.IUPS-01	UPS - For 2.2 Ah battery	

### 4.2.1.1.3 Technical data

#### Information:

The following specified characteristic data, features and limit values are only valid for these individual components and may differ from those of the complete system. The data specified for the complete system applies to the complete system in which this individual component is used, for example.

Order number	5APC3100.KBU0-000	5APC3100.KBU1-000	5APC3100.KBU2-000	5APC3100.KBU3-000
<b>General information</b>				
LEDs	Power, Disk, Link, Run			
B&R ID code	0xEF96	0xEF97	0xEF98	0xEF99
Cooling	Passive via heat sink			
<b>Battery</b>				
Type	Renata 950 mAh			
Service life	4 years <sup>1)</sup>			
Removable	Yes			
Variant	Lithium ion			
Power button	Yes			
Reset button	Yes			
Buzzer	No			
<b>Certifications</b>				
CE	Yes			
UL	cULus E115267 Industrial control equipment			
HazLoc	cULus HazLoc E180196 Industrial control equipment for hazardous locations Class I, Division 2, Groups ABCD, T4 <sup>2)</sup>			
DNV	Temperature: <b>B</b> (0 - 55°C) Humidity: <b>B</b> (up to 100%) Vibration: <b>A</b> (0.7 g) EMC: <b>B</b> (bridge and open deck) <sup>3)</sup>	-		Temperature: <b>B</b> (0 - 55°C) Humidity: <b>B</b> (up to 100%) Vibration: <b>A</b> (0.7 g) EMC: <b>B</b> (bridge and open deck) <sup>3)</sup>
EAC	Product family certification			
<b>Controller</b>				
Bootloader	UEFI BIOS			
<b>Processor</b>				
Type	Intel C-3965U	Intel i3-7100U	Intel i5-7300U	Intel i7-7600U
Clock frequency	2200 MHz	2400 MHz	2600 MHz	2800 MHz
Number of cores	2			
Architecture	14 nm			
Thermal design power (TDP)	15 W			
L2 cache	2 MB	3 MB		4 MB
Intel 64 architecture	Yes			
Intel Turbo Boost Technology	No	No	Yes	Yes
Intel Hyper-Threading Technology	No	Yes		
Intel vPro Technology	No	Yes		Yes
Intel Virtualization Technology (VT-x)	Yes			
Intel Virtualization Technology for Directed I/O (VT-d)	Yes			
Enhanced Intel SpeedStep Technology	Yes			
<b>Chipset</b>				
Trusted Platform Module	Intel KabyLake-U TPM 2.0			
<b>Real-time clock</b>				
Accuracy	At 25°C: Typ. 12 ppm (1 second) per day <sup>4)</sup>			
Battery-backed	Yes			
<b>Power failure logic</b>				
Controller	MTCX <sup>5)</sup>			
Buffer time	10 ms			
<b>Memory</b>				
Removable	Yes			
<b>Memory slot</b>				
Number of memory channels	2			
Type	DDR4 SDRAM			
Memory size	Max. 32 GB			
Max. memory bandwidth	34.1 GB/s			
<b>Graphics</b>				
Controller	Intel HD Graphics 610	Intel HD Graphics 620		
Color depth	Max. 32-bit			
DirectX support	12			
OpenGL support	4.4			
Power management	ACPI 5.0			

Order number	5APC3100.KBU0-000	5APC3100.KBU1-000	5APC3100.KBU2-000	5APC3100.KBU3-000
<b>Interfaces</b>				
CFAST slot				
Quantity			2	
Type			SATA III (SATA 6.0 Gbit/s)	
<b>USB</b>				
Quantity			5	
Type			4x USB 3.0 1x USB 2.0 (internal for Technology Guard)	
Variant			Type A	
Transfer rate			Low speed (1.5 Mbit/s), full speed (12 Mbit/s), high speed (480 Mbit/s) to SuperSpeed (5 Gbit/s) <sup>6)</sup>	
Current-carrying capacity			Max. 1 A per connection	
<b>Ethernet</b>				
Quantity			2	
Variant			RJ45, shielded	
Transfer rate			10/100/1000 Mbit/s	
Max. baud rate			1 Gbit/s	
<b>SDL/DVI-D interface</b>				
Variant			DVI-D	
Type			SDL/DVI	
<b>Slots</b>				
Interface option <sup>7)</sup>			3	
<b>Electrical properties</b>				
Nominal voltage			24 VDC ±25%, SELV <sup>8)</sup>	
Nominal current			Max. 5.5 A	
Inrush current			Max. 60 A for < 300 µs	
Overvoltage category per EN 61131-2			II	
Galvanic isolation			Yes	
<b>Operating conditions</b>				
Pollution degree per EN 61131-2			Pollution degree 2	
Degree of protection per EN 60529			IP20 <sup>9)</sup>	
<b>Ambient conditions</b>				
Elevation				
Operation			Max. 3000 m (component-dependent) <sup>10)</sup>	
<b>Mechanical properties</b>				
Dimensions <sup>11)</sup>				
Width			54 mm	
Height			173.5 mm	
Depth			248.3 mm	
Weight			1380 g	

- 1) At 50°C, 8.5 µA for the components being supplied and self-discharge of 40%. If an interface option with SRAM or POWERLINK is installed, the service life is 2 1/2 years.
- 2) Yes, but applies only if all components installed in the complete system have this certification and the complete system bears the corresponding mark.
- 3) Yes, but applies only if all components installed in the complete system have this certification and are listed on the associated DNV certificate for the product family.
- 4) At max. specified ambient temperature: Typ. 58 ppm (5 seconds) - worst case 220 ppm (19 seconds).
- 5) Maintenance Controller Extended
- 6) The SuperSpeed transfer rate (5 Gbit/s) is only possible with USB 3.0.
- 7) The interface option can be replaced.
- 8) IEC 61010-2-201 requirements must be observed.
- 9) Only if all interface covers are installed.
- 10) The maximum ambient temperature is typically derated 1°C per 1000 meters starting at 500 m above sea level.
- 11) All dimensions without mounting plate.

## 4.2.2 Main memory

### 4.2.2.1 5MMDDR.xxxx-04

#### 4.2.2.1.1 General information

These 260-pin DDR4 main memory modules operate with a data rate of 2133 MHz and are available in sizes ranging from 4 GB to 16 GB.

If two main memory modules of identical size (e.g. 4 GB) are connected to the CPU board, then dual-channel memory technology is supported. This technology is not supported if two main memory modules of different sizes (e.g. 4 GB and 8 GB) are connected.

#### 4.2.2.1.2 Order data

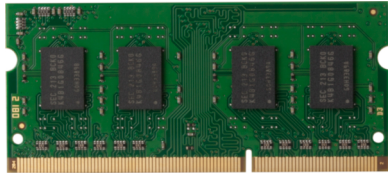
Order number	Short description	Figure
	<b>Main memory</b>	
5MMDDR.4096-04	SO-DIMM DDR4, 4096 MB	
5MMDDR.8192-04	SO-DIMM DDR4, 8192 MB	
5MMDDR.016G-04	SO-DIMM DDR4, 16384 MB	

#### 4.2.2.1.3 Technical data

### Information:

The following specified characteristic data, features and limit values are only valid for these individual components and may differ from those of the complete system. The data specified for the complete system applies to the complete system in which this individual component is used, for example.

Order number	5MMDDR.4096-04	5MMDDR.8192-04	5MMDDR.016G-04
<b>General information</b>			
Certifications		Yes	
CE		Yes	
UL		cULus E115267 Industrial control equipment	
DNV		Temperature: <b>B</b> (0 - 55°C) Humidity: <b>B</b> (up to 100%) Vibration: <b>A</b> (0.7 g) EMC: <b>B</b> (bridge and open deck) <sup>1)</sup>	
EAC		Product family certification	
<b>Controller</b>			
Memory			
Type		SO-DIMM DDR4 SDRAM	
Memory size	4 GB	8 GB	16 GB
Construction		260-pin	
Organization	512M x 64-bit	1024M x 64-bit	2048M x 64-bit
Velocity		DDR4-2133 (PC4-17000)	
<b>Operating conditions</b>			
Pollution degree per EN 61131-2		Pollution degree 2	

1) Yes, but applies only if all components installed in the complete system have this certification and are listed on the associated DNV certificate for the product family.



### 4.2.3 Graphics options

#### Information:

Graphics options can only be operated in the IF option 3 slot.

#### Information:

For information about replacing or installing a graphics option, see section ["Installing the interface option and DDR4 SDRAM" on page 220](#).

After installation or replacement, it may be necessary to load the defaults settings in BIOS (see ["Exit" on page 178](#)).

#### 4.2.3.1 5ACCLI02.DPO0-000

##### 4.2.3.1.1 General information

Graphics option 5ACCLI02.DPO0-000 is equipped with a DisplayPort and USB 2.0 interface.

- DisplayPort interface
- USB 2.0 interface
- Compatible with APC3100/PPC3100

##### 4.2.3.1.2 Order data

Order number	Short description	Figure
	<b>Graphics options</b>	
5ACCLI02.DPO0-000	Graphics option - 1x DisplayPort transmitter (version 1.2) - For APC3100/PPC3100	

##### 4.2.3.1.3 Technical data

#### Information:

The following specified characteristic data, features and limit values are only valid for this accessory and may differ from those of the complete system. The data specified for the complete system applies to the complete system in which this accessory is installed, for example.

Order number	5ACCLI02.DPO0-000
<b>General information</b>	
B&R ID code	0xEEE6
Certifications	
CE	Yes
UL	cULus E115267 Industrial control equipment
HazLoc	cULus HazLoc E180196 Industrial control equipment for hazardous locations Class I, Division 2, Groups ABCD, T4 <sup>1)</sup>
EAC	Product family certification
<b>Interfaces</b>	
USB	
Quantity	1
Type	USB 2.0
Variant	Type A
Transfer rate	Low speed (1.5 Mbit/s), full speed (12 Mbit/s) to high speed (480 Mbit/s)
Current-carrying capacity	Max. 0.5 A
DisplayPort	
Quantity	1
Version	1.2
<b>Electrical properties</b>	
Power consumption	3 W
<b>Operating conditions</b>	
Pollution degree per EN 61131-2	Pollution degree 2

## Technical data

<b>Order number</b>	<b>5ACCLI02.DPO0-000</b>
<b>Ambient conditions</b>	
Temperature	
Operation	0 to 60°C <sup>2)</sup>
Storage	-20 to 60°C
Transport	-20 to 60°C
Relative humidity	
Operation	5 to 90%, non-condensing
Storage	5 to 95%, non-condensing
Transport	5 to 95%, non-condensing
<b>Mechanical properties</b>	
Weight	Approx. 27 g

- 1) Yes, but applies only if all components installed in the complete system have this certification and the complete system bears the corresponding mark.
- 2) For detailed information, see the temperature tables in the user's manual.

### 4.2.3.1.3.1 DisplayPort interface

The DisplayPort interface is 20-pin (female) and can be operated with DisplayPort, DVI or HDMI transmission technologies.

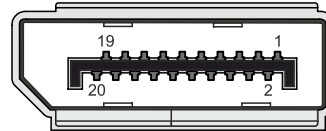

Pin	Pinout	Description	Pin	Pinout	Description
1	DP_LANE0+	DisplayPort lane 0 (positive)	11	GND	Ground
2	GND	Ground	12	DP_LANE3-	DisplayPort lane 3 (negative)
3	DP_LANE0-	DisplayPort lane 0 (negative)	13	CONFIG1	Configuration pin 1 (connected to ground)
4	DP_LANE1+	DisplayPort lane 1 (positive)	14	CONFIG2	Configuration pin 2 (connected to ground)
5	GND	Ground	15	DP_AUX+	Auxiliary channel (positive)
6	DP_LANE1-	DisplayPort lane 1 (negative)	16	GND	Ground
7	DP_LANE2+	DisplayPort lane 2 (positive)	17	DP_AUX-	Auxiliary channel (negative)
8	GND	Ground	18	DP_HPD#	Hot plug detection
9	DP_LANE2-	DisplayPort lane 2 (negative)	19	RETURN	Return for power
10	DP_LANE3+	DisplayPort lane 3 (positive)	20	DP_PWR	Power for connector

### Information:

Hot plugging output devices on the interface for service purposes is supported by the hardware and graphic drivers of approved operating systems.

A maximum of 10,000 mating cycles are specified for this interface.

### 4.2.3.2 5ACCLI02.SDL0-000

#### 4.2.3.2.1 General information

Graphics option 5ACCLI02.SDL0-000 is equipped with an SDL/DVI-D interface for connecting additional panels via SDL or DVI.

- SDL/DVI interface
- Compatible with APC3100/PPC3100

#### 4.2.3.2.2 Order data

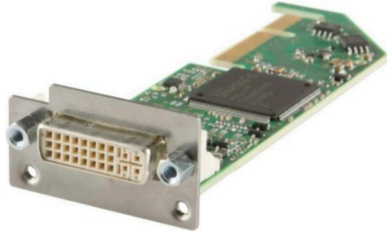
Order number	Short description	Figure
5ACCLI02.SDL0-000	Graphics options Graphics option - 1x SDL/DVI transmitter - For APC3100/PPC3100	

#### 4.2.3.2.3 Technical data

### Information:

The following specified characteristic data, features and limit values are only valid for this accessory and may differ from those of the complete system. The data specified for the complete system applies to the complete system in which this accessory is installed, for example.

Order number	5ACCLI02.SDL0-000
<b>General information</b>	
B&R ID code	0xEEE7
Certifications	
CE	Yes
UL	cULus E115267 Industrial control equipment
HazLoc	cULus HazLoc E180196 Industrial control equipment for hazardous locations Class I, Division 2, Groups ABCD, T4 <sup>1)</sup>
DNV	Temperature: <b>B</b> (0 - 55°C) Humidity: <b>B</b> (up to 100%) Vibration: <b>A</b> (0.7 g) EMC: <b>B</b> (bridge and open deck) <sup>2)</sup>
EAC	Product family certification
<b>Interfaces</b>	
SDL/DVI-D interface	
Variant	DVI-D
Type	SDL/DVI
<b>Electrical properties</b>	
Power consumption	1 W
<b>Operating conditions</b>	
Pollution degree per EN 61131-2	Pollution degree 2
<b>Ambient conditions</b>	
Temperature	
Operation	0 to 60°C <sup>3)</sup>
Storage	-20 to 60°C
Transport	-20 to 60°C
Relative humidity	
Operation	5 to 90%, non-condensing
Storage	5 to 95%, non-condensing
Transport	5 to 95%, non-condensing
<b>Mechanical properties</b>	
Weight	Approx. 27 g

- 1) Yes, but applies only if all components installed in the complete system have this certification and the complete system bears the corresponding mark.
- 2) Yes, but applies only if all components installed in the complete system have this certification and are listed on the associated DNV certificate for the product family.
- 3) For detailed information, see the temperature tables in the user's manual.

#### 4.2.3.2.3.1 SDL/DVI interface

The interface is designed as a DVI-I connector (female) and can be operated with DVI-D or SDL transmission technology.

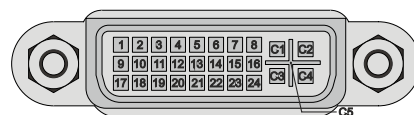

Pin	Pinout	Description	Pin	Pinout	Description
1	TMDS data 2-	DVI lane 2 (negative)	16	HPD	Hot plug detection
2	TMDS data 2+	DVI lane 2 (positive)	17	TMDS data 0-	DVI lane 0 (negative)
3	TMDS data 2/4 SHIELD	Shield for data pairs 2 and 4	18	TMDS data 0+	DVI lane 0 (positive)
4	SDL-	SDL lane (negative)	19	TMDS data 0/XUSB1 SHIELD	Shield of data pair 0 and USB1
5	SDL+	SDL lane (positive)	20	XUSB1-	USB lane 1 (negative)
6	DDC clock	DDC-based control signal (clock)	21	XUSB1+	USB lane 1 (positive)
7	DDC data	DDC-based control signal (data)	22	TMDS clock shield	Shield of clock pair
8	Not connected	Not connected	23	TMDS clock+	DVI clock (positive)
9	TMDS data 1-	DVI lane 1 (negative)	24	TMDS clock -	DVI clock (negative)
10	TMDS data 1+	DVI lane 1 (positive)	C1	Not connected	Not connected
11	TMDS data 1/XUSB0 SHIELD	Shield of data pair 1 and USB0	C2	Not connected	Not connected
12	XUSB0-	USB lane 0 (negative)	C3	Not connected	Not connected
13	XUSB0+	USB lane 0 (positive)	C4	Not connected	Not connected
14	+5 V power <sup>1)</sup>	+5 V power supply	C5	Not connected	Not connected
15	Ground (return for +5 V, HSync and VSync)	Ground	-	-	-

1) Protected internally by a multifuse.

### Information:

Hot plugging output devices on the interface for service purposes is supported by the hardware and graphic drivers of approved operating systems. Recalibration may be required for touch screen devices.

A maximum of 100 mating cycles are specified for this interface.

### Information:

In SDL operation without USB type A/B cable, the USB transfer rate is limited to USB 1.1.

A USB transfer rate of USB 2.0 is possible in DVI or SDL operation with a USB type A/B cable.

#### 4.2.3.2.3.2 Cable lengths and resolutions for SDL transfer

The following table shows the relationship between segment length and maximum resolution depending on the SDL cable:

SDL cable Segment length [m]	Resolution						
	VGA 640 x 480	SVGA 800 x 600	XGA 1024 x 768	HD 1366 x 768	SXGA 1280 x 1024	UXGA 1600 x 1200	FHD 1920 x 1080
0.8	5CASDL.0008-00	5CASDL.0008-00	5CASDL.0008-00	5CASDL.0008-00	5CASDL.0008-00	5CASDL.0008-00	5CASDL.0008-00
1.8	5CASDL.0018-00	5CASDL.0018-00	5CASDL.0018-00	5CASDL.0018-00	5CASDL.0018-00	5CASDL.0018-00	5CASDL.0018-00
	5CASDL.0018-01	5CASDL.0018-01	5CASDL.0018-01	5CASDL.0018-01	5CASDL.0018-01	5CASDL.0018-01	5CASDL.0018-01
	5CASDL.0018-03	5CASDL.0018-03	5CASDL.0018-03	5CASDL.0018-03	5CASDL.0018-03	5CASDL.0018-03	5CASDL.0018-03
5	5CASDL.0050-00	5CASDL.0050-00	5CASDL.0050-00	5CASDL.0050-00	5CASDL.0050-00	5CASDL.0050-00	5CASDL.0050-00
	5CASDL.0050-01	5CASDL.0050-01	5CASDL.0050-01	5CASDL.0050-01	5CASDL.0050-01	5CASDL.0050-01	5CASDL.0050-01
	5CASDL.0050-03	5CASDL.0050-03	5CASDL.0050-03	5CASDL.0050-03	5CASDL.0050-03	5CASDL.0050-03	5CASDL.0050-03
6	5CASDL.0060-00	5CASDL.0060-00	5CASDL.0060-00	5CASDL.0060-00	5CASDL.0060-00	5CASDL.0060-00	5CASDL.0060-00
10	5CASDL.0100-00	5CASDL.0100-00	5CASDL.0100-00	5CASDL.0100-00	5CASDL.0100-00	5CASDL.0100-00	5CASDL.0100-00
	5CASDL.0100-01	5CASDL.0100-01	5CASDL.0100-01	5CASDL.0100-01	5CASDL.0100-01	5CASDL.0100-01	5CASDL.0100-01
	5CASDL.0100-03	5CASDL.0100-03	5CASDL.0100-03	5CASDL.0100-03	5CASDL.0100-03	5CASDL.0100-03	5CASDL.0100-03
	5CASDL.0150-00	5CASDL.0150-00	5CASDL.0150-00	5CASDL.0150-00	5CASDL.0150-00	-	-
15	5CASDL.0150-01	5CASDL.0150-01	5CASDL.0150-01	5CASDL.0150-01	5CASDL.0150-01	-	-
	5CASDL.0150-03	5CASDL.0150-03	5CASDL.0150-03	5CASDL.0150-03	5CASDL.0150-03	-	5CASDL.0150-03
	5CASDL.0200-00	5CASDL.0200-00	5CASDL.0200-00	5CASDL.0200-00	5CASDL.0200-00	-	-
20	5CASDL.0200-03	5CASDL.0200-03	5CASDL.0200-03	5CASDL.0200-03	5CASDL.0200-03	-	5CASDL.0200-03
	5CASDL.0250-00	5CASDL.0250-00	5CASDL.0250-00	5CASDL.0250-00	-	-	-
25	5CASDL.0250-03	5CASDL.0250-03	5CASDL.0250-03	5CASDL.0250-03	-	-	-
	5CASDL.0300-00	5CASDL.0300-00	-	-	-	-	-
30	5CASDL.0300-03	5CASDL.0300-03	5CASDL.0300-13	5CASDL.0300-13	5CASDL.0300-13	-	5CASDL.0300-13
	5CASDL.0400-13	5CASDL.0400-13	5CASDL.0400-13	5CASDL.0400-13	5CASDL.0400-13	-	5CASDL.0400-13

#### 4.2.3.2.3.3 Cable lengths and resolutions for DVI transfer

The following table shows the relationship between segment length and maximum resolution depending on the DVI cable:

DVI cable Segment length [m]	Resolution						
	VGA 640 x 480	SVGA 800 x 600	XGA 1024 x 768	HD 1366 x 768	SXGA 1280 x 1024	UXGA 1600 x 1200	FHD 1920 x 1080
1.8	5CADVI.0018-00	5CADVI.0018-00	5CADVI.0018-00	5CADVI.0018-00	5CADVI.0018-00	5CADVI.0018-00	5CADVI.0018-00
5	5CADVI.0050-00	5CADVI.0050-00	5CADVI.0050-00	5CADVI.0050-00	5CADVI.0050-00	5CADVI.0050-00	5CADVI.0050-00

The maximum cable length for DVI transfer is limited to 5 m due to the USB specification.

### 4.2.3.3 5ACCLI02.SD40-000

#### 4.2.3.3.1 General information

Graphics option 5ACCLI02.SD40-000 is equipped with an SDL4 interface.

- SDL4 interface
- Compatible with APC3100/PPC3100

#### 4.2.3.3.2 Order data

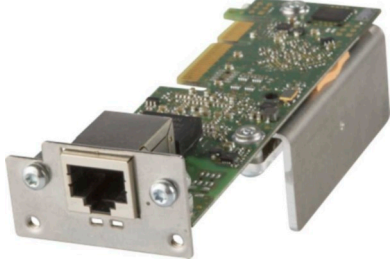
Order number	Short description	Figure
5ACCLI02.SD40-000	Graphics option - 1x SDL4 transmitter (max. 1920 x 1080) - For APC3100/PPC3100	

#### 4.2.3.3.3 Technical data

##### Information:

The following specified characteristic data, features and limit values are only valid for this accessory and may differ from those of the complete system. The data specified for the complete system applies to the complete system in which this accessory is installed, for example.

Order number	5ACCLI02.SD40-000
<b>General information</b>	
LEDs	Status, Link
B&R ID code	0xECCC
<b>Certifications</b>	
CE	Yes
UL	cULus E115267 Industrial control equipment
EAC	Product family certification
<b>Interfaces</b>	
SDL4 Out	
Variant	RJ45, shielded
Type	SDL4
<b>Electrical properties</b>	
Power consumption	4.5 W
<b>Operating conditions</b>	
Pollution degree per EN 61131-2	Pollution degree 2
<b>Ambient conditions</b>	
Temperature	
Operation	0 to 55°C <sup>1)</sup>
Storage	-20 to 60°C
Transport	-20 to 60°C
Relative humidity	
Operation	5 to 90%, non-condensing
Storage	5 to 95%, non-condensing
Transport	5 to 95%, non-condensing
<b>Mechanical properties</b>	
Weight	Approx. 38 g

1) For detailed information, see the temperature tables in the user's manual.

#### 4.2.3.3.3.1 SDL4 interface

The SDL4 interface is a female RJ45 connector and operated with SDL4 transmission technology.

SDL4 LEDs			
LED	Color	Status	Explanation
Link (a)	Yellow	On	Indicates an active SDL4 connection.
		Off	No active SDL4 connection.
Status (b)	Yellow	On	The SDL4 connection is established and OK.
		Blinking	No active SDL4 connection.

**Information:**

Hot plugging output devices on the interface for service purposes is supported by the hardware and graphic drivers of approved operating systems. Recalibration may be required for touch screen devices.

A maximum of 500 mating cycles are specified for this interface.

**4.2.3.3.3.2 Cable lengths and resolutions for SDL4 transfer**

The maximum cable length for SDL4 transfer with a B&R SDL3/SDL4 cable is 100 meters (regardless of the resolution of the panel).

## 4.2.4 Interface options

### Information:

It is important to note that not every interface option can be connected in interface slots 1 and 2. For additional information, see sections "IF option 1 slot" on page 48 and "IF option 2 slot" on page 49.

### Information:

For information about replacing or installing an interface option, see section "Installing the interface option and DDR4 SDRAM" on page 220.

Depending on the IF option used, it may be necessary to load the default settings in BIOS after replacement or installation (see "Exit" on page 178).

### 4.2.4.1 5AC901.I232-00

#### 4.2.4.1.1 General information

Interface option 5AC901.I232-00 is equipped with an RS232 interface.

- 1x RS232 interface
- Compatible with APC910/PPC900 and APC3100/PPC3100

Simultaneous operation of this interface option in slot IF option 1 with interface option 5ACCIF02.ISS0-000 in slot IF option 2 is not possible.

#### 4.2.4.1.2 Order data

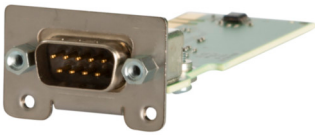
Order number	Short description	Figure
	<b>Interface options</b>	
5AC901.I232-00	Interface card - 1x RS232 interface - For APC910/PPC900/ APC3100/PPC3100	

#### 4.2.4.1.3 Technical data

### Information:

The following specified characteristic data, features and limit values are only valid for this accessory and may differ from those of the complete system. The data specified for the complete system applies to the complete system in which this accessory is installed, for example.

Order number	5AC901.I232-00
<b>General information</b>	
B&R ID code	0xF400
Certifications	
CE	Yes
UL	cULus E115267 Industrial control equipment
EAC	Product family certification
<b>Interfaces</b>	
COM	
Type	RS232, modem supported, not galvanically isolated
Variant	DSUB, 9-pin, male
UART	16550-compatible, 16-byte FIFO buffer
Max. baud rate	115 kbit/s
<b>Electrical properties</b>	
Power consumption	1 W
<b>Operating conditions</b>	
Pollution degree per EN 61131-2	Pollution degree 2
<b>Ambient conditions</b>	
Temperature	
Operation	0 to 60°C <sup>1)</sup>
Storage	-20 to 60°C
Transport	-20 to 60°C



<b>Order number</b>	<b>5AC901.I232-00</b>
Relative humidity	
Operation	5 to 90%, non-condensing
Storage	5 to 95%, non-condensing
Transport	5 to 95%, non-condensing
<b>Mechanical properties</b>	
Weight	Approx. 30 g

1) For detailed information, see the temperature tables in the user's manual.

#### 4.2.4.1.3.1 Pinout

Serial interface COM <sup>1)</sup>	
RS232	
Variant	DSUB, 9-pin, male
Type	RS232, modem supported
UART	16550-compatible, 16-byte FIFO buffer
Galvanic isolation	No
Transfer rate	Max. 115 kbit/s
Bus length	Max. 15 m
Pin	Pinout
1	DCD
2	RXD
3	TXD
4	DTR
5	GND
6	DSR
7	RTS
8	CTS
9	RI

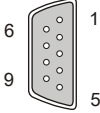

1) The interfaces, etc. available on the device or module have been numbered for the purpose of clear differentiation. This numbering may deviate from the numbering used by the respective operating system, however.

#### 4.2.4.1.3.2 I/O address and IRQ

When operated in the xPC3100:

Slot	I/O address <sup>1)</sup>	IRQ <sup>1)</sup>
IF option 1 (COM C)	2E8h - 2EFh	5
IF option 2 (COM D)	338h - 33Fh	7

1) The default I/O address and IRQ can be modified in BIOS.

#### 4.2.4.1.3.3 Cable data

For more detailed information about the transfer rate, bus length or cable requirements for the respective interfaces/buses, see "Cable data" on page 245.

#### 4.2.4.1.4 Driver support

Drivers for approved operating systems are available for download in the Downloads section of the B&R website ([www.br-automation.com](http://www.br-automation.com)) (if required and not already included in the operating system).

Approved operating systems:

- Automation Runtime
- B&R Linux
- Windows 10

### 4.2.4.2 5AC901.I485-00

#### 4.2.4.2.1 General information

Interface option 5AC901.I485-00 is equipped with an RS232/RS422/RS485 interface. The operating mode (RS232/RS422/RS485) is selected automatically depending on the electrical connection.

- 1x RS232/RS422/RS485 interface
- Compatible with APC910/PPC900 and APC3100/PPC3100

Simultaneous operation of this interface option in slot IF option 1 with interface option 5ACCIF02.ISS0-000 in slot IF option 2 is not possible.

#### 4.2.4.2.2 Order data

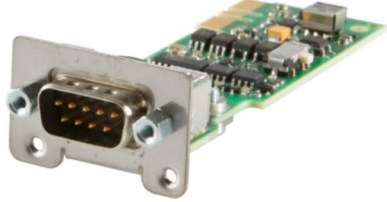
Order number	Short description	Figure
5AC901.I485-00	Interface card - 1x RS232/RS422/RS485 interface - For APC910/PPC900/APC3100/PPC3100	

#### 4.2.4.2.3 Technical data

### Information:

The following specified characteristic data, features and limit values are only valid for this accessory and may differ from those of the complete system. The data specified for the complete system applies to the complete system in which this accessory is installed, for example.

Order number	5AC901.I485-00
<b>General information</b>	
B&R ID code	0xD84A
Certifications	
CE	Yes
UL	cULus E115267 Industrial control equipment
HazLoc	cULus HazLoc E180196 Industrial control equipment for hazardous locations Class I, Division 2, Groups ABCD, T4 <sup>1)</sup>
DNV	Temperature: <b>B</b> (0 - 55°C) Humidity: <b>B</b> (up to 100%) Vibration: <b>A</b> (0.7 g) EMC: <b>B</b> (bridge and open deck) <sup>2)</sup>
EAC	Product family certification
<b>Interfaces</b>	
COM	
Type	RS232/RS422/RS485, galvanically isolated
Variant	DSUB, 9-pin, male
UART	16550-compatible, 16-byte FIFO buffer
Max. baud rate	115 kbit/s
Terminating resistor	
Type	Can be switched on and off with slide switch
Default setting	Off
<b>Electrical properties</b>	
Power consumption	1 W
<b>Operating conditions</b>	
Pollution degree per EN 61131-2	Pollution degree 2
<b>Ambient conditions</b>	
Temperature	
Operation	0 to 55°C <sup>3)</sup>
Storage	-20 to 60°C
Transport	-20 to 60°C

<b>Order number</b>	<b>5AC901.I485-00</b>
Relative humidity	
Operation	5 to 90%, non-condensing
Storage	5 to 95%, non-condensing
Transport	5 to 95%, non-condensing
<b>Mechanical properties</b>	
Weight	Approx. 34 g

- 1) Yes, but applies only if all components installed in the complete system have this certification and the complete system bears the corresponding mark.
- 2) Yes, but applies only if all components installed in the complete system have this certification and are listed on the associated DNV certificate for the product family.
- 3) For detailed information, see the temperature tables in the user's manual.

#### 4.2.4.2.3.1 Pinout

Serial interface COM			
	RS232	RS422/485	
Variant	DSUB, 9-pin, male		
Type	RS232, not modem supported		
UART	16550-compatible, 16-byte FIFO buffer		
Galvanic isolation	Yes		
Transfer rate	Max. 115 kbit/s		
Bus length	Max. 15 m	Max. 1200 m	
Pin	RS232 - Pinout	RS422 - Pinout	
1	NC. <sup>1)</sup>	TXD\	
2	RXD	NC.	
3	TXD	NC.	
4	NC.	TXD	
5	GND	GND	
6	NC.	RXD\	
7	RTS	NC.	
8	CTS	NC.	
9	NC.	RXD	

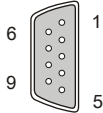

- 1) Not connected

#### 4.2.4.2.3.2 I/O address and IRQ

When operated in the xPC3100:

Slot	I/O address <sup>1)</sup>	IRQ <sup>1)</sup>
IF option 1 (COM C)	2E8h - 2EFh	5
IF option 2 (COM D)	338h - 33Fh	7

- 1) The default I/O address and IRQ can be modified in BIOS.

#### 4.2.4.2.3.3 Cable data

For more detailed information about the transfer rate, bus length or cable requirements for the respective interfaces/buses, see "[Cable data](#)" on page 245.

#### 4.2.4.2.3.4 Operation as RS485 interface

The pins of the RS422 default interface (1, 4, 6 and 9) must be used for operation. To do this, connect the pins as shown.

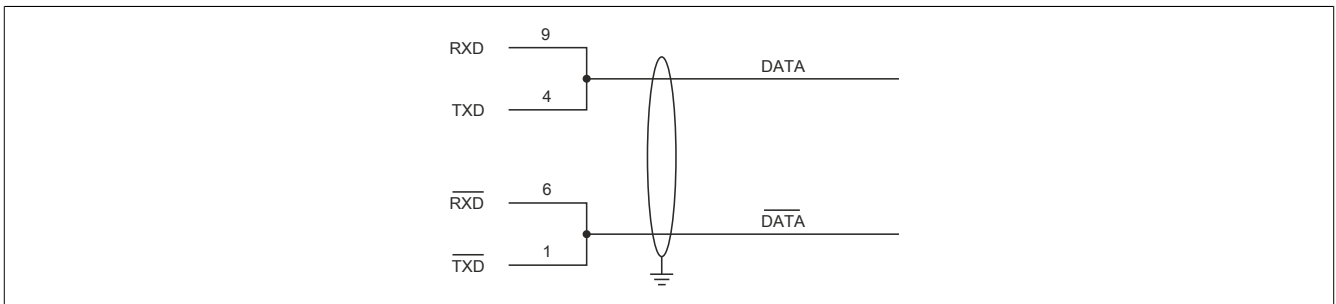

Figure 1: RS232/RS422/RS485 interface - Operation in RS485 mode

The RTS line must be switched by the driver for each transmission or reception; switching back does not take place automatically. This cannot be configured in Windows.

With long cable lengths, the voltage drop can result in greater potential differences between the bus devices, which can hinder communication. This can be improved by running the ground wire with the others.

The cable ends of an RS485 bus should be terminated (at least for longer cable lengths or higher transfer rates). Passive termination can normally be used by connecting the signal lines via a 120 Ω resistor at each of the two bus ends; see "Terminating resistor" for the IF card.

#### 4.2.4.2.3.5 Terminating resistor

A terminating resistor for the serial interface is already integrated in the IF option. This can be switched on or off with a switch (1); it is necessary to open the system unit for this. A switched-on terminating resistor is indicated by a yellow LED (2) (see "Reading LED status indicators" on page 244).

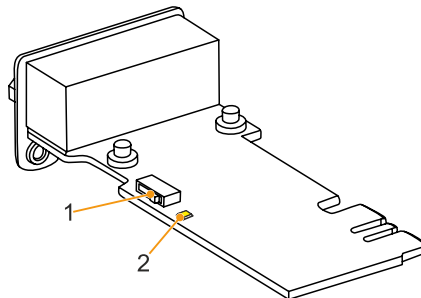

#### 4.2.4.2.4 Driver support

Drivers for approved operating systems are available for download in the Downloads section of the B&R website ([www.br-automation.com](http://www.br-automation.com)) (if required and not already included in the operating system).

Approved operating systems:

- Automation Runtime
- B&R Linux
- Windows 10

### 4.2.4.3 5AC901.ICAN-00

#### 4.2.4.3.1 General information

Interface option 5AC901.ICAN-00 is equipped with a CAN bus master interface.

- 1x CAN bus master interface
- Compatible with APC910/PPC900 and APC3100/PPC3100

Simultaneous operation of 2 interface options with a legacy CAN interface in slots IF option 1 and IF option 2 is not possible.

#### 4.2.4.3.2 Order data

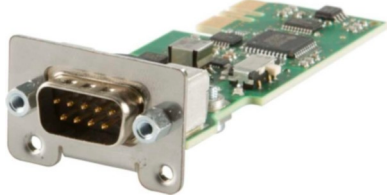
Order number	Short description	Figure
	<b>Interface options</b>	
5AC901.ICAN-00	Interface card - 1x CAN interface - For APC910/PPC900/ APC3100/PPC3100	

#### 4.2.4.3.3 Technical data

### Information:

The following specified characteristic data, features and limit values are only valid for this accessory and may differ from those of the complete system. The data specified for the complete system applies to the complete system in which this accessory is installed, for example.

Order number	5AC901.ICAN-00
<b>General information</b>	
B&R ID code	0xD84B
Certifications	
CE	Yes
UL	cULus E115267 Industrial control equipment
HazLoc	cULus HazLoc E180196 Industrial control equipment for hazardous locations Class I, Division 2, Groups ABCD, T4 <sup>1)</sup>
DNV	Temperature: <b>B</b> (0 - 55°C) Humidity: <b>B</b> (up to 100%) Vibration: <b>A</b> (0.7 g) EMC: <b>B</b> (bridge and open deck) <sup>2)</sup>
EAC	Product family certification
<b>Interfaces</b>	
CAN	
Quantity	1
Controller	Bosch CC770 (compatible with Intel 82527 CAN controller)
Variant	DSUB, 9-pin, male, galvanically isolated
Transfer rate	Max. 1 Mbit/s
Terminating resistor	
Type	Can be switched on and off with slide switch
Default setting	Off
<b>Electrical properties</b>	
Power consumption	1 W
<b>Operating conditions</b>	
Pollution degree per EN 61131-2	Pollution degree 2
<b>Ambient conditions</b>	
Temperature	
Operation	0 to 60°C <sup>3)</sup>
Storage	-20 to 60°C
Transport	-20 to 60°C

## Technical data

<b>Order number</b>	<b>5AC901.ICAN-00</b>
Relative humidity	
Operation	5 to 90%, non-condensing
Storage	5 to 95%, non-condensing
Transport	5 to 95%, non-condensing
<b>Mechanical properties</b>	
Weight	Approx. 33 g

- 1) Yes, but applies only if all components installed in the complete system have this certification and the complete system bears the corresponding mark.
- 2) Yes, but applies only if all components installed in the complete system have this certification and are listed on the associated DNV certificate for the product family.
- 3) For detailed information, see the temperature tables in the user's manual.

### 4.2.4.3.3.1 Pinout

CAN bus	
Variant	DSUB, 9-pin, male
Galvanic isolation	Yes
Transfer rate	Max. 1 Mbit/s
Bus length	Max. 1000 meters
Pin	Pinout
1	NC. <sup>1)</sup>
2	CAN LOW
3	GND
4	NC.
5	NC.
6	Reserved
7	CAN HIGH
8	NC.
9	NC.

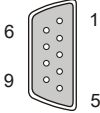

- 1) Not connected

### 4.2.4.3.3.2 I/O address and IRQ

Resource	Default setting	Function
I/O address	384h (address register)	Defines the register number to be accessed.
	385h (data register)	Access to the register defined in the address register.
IRQ	IRQ10	Interrupt

- 1) Resource allocation is identical for the interface option 1 and 2 slots.

### 4.2.4.3.3.3 CAN driver settings

The baud rate can be set either with predefined values or via the bit timing register.

For additional information about CAN interfaces with AS/AR support, see Automation Help. For additional information about CAN interfaces without AS/AR support, see the user's manual for the B&R CAN driver at [www.br-automation.com](http://www.br-automation.com).

Bit timing register 0	Bit timing register 1	Baud rate
00h	14h	1000 kbit/s
80h or 00h	1Ch	500 kbit/s
81h or 01h	1Ch	250 kbit/s
83h or 03h	1Ch	125 kbit/s
84h or 04h	1Ch	100 kbit/s
89h or 09h	1Ch	50 kbit/s

### 4.2.4.3.3.4 Cable data

For more detailed information about the transfer rate, bus length or cable requirements for the respective interfaces/buses, see "Cable data" on page 245.

#### 4.2.4.3.3.5 Terminating resistor

A terminating resistor for the CAN interface is already integrated in the IF option. This can be switched on or off with a switch (1); it is necessary to open the system unit for this. A switched-on terminating resistor is indicated by a yellow LED (2) (see "Reading LED status indicators" on page 244).

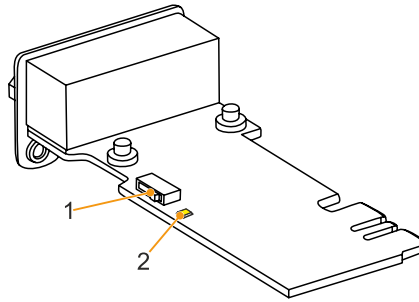

#### 4.2.4.3.4 Driver support

Drivers for approved operating systems are available for download in the Downloads section of the B&R website ([www.br-automation.com](http://www.br-automation.com)) (if required and not already included in the operating system).

Approved operating systems:

- Automation Runtime
- Windows 10

#### 4.2.4.4 5AC901.ICAN-01

##### 4.2.4.4.1 General information

Interface option 5AC901.ICAN-01 is equipped with a CAN bus master interface.

- 1x CAN bus master interface (SJA1000)
- Compatible with APC910/PPC900 and APC3100/PPC3100

Simultaneous operation of 2 interface options with a legacy CAN interface in slots IF option 1 and IF option 2 is not possible.

##### 4.2.4.4.2 Order data

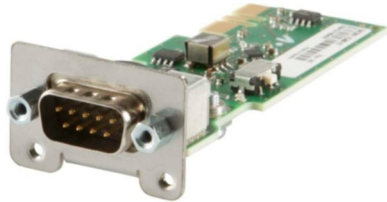
Order number	Short description	Figure
	<b>Interface options</b>	
5AC901.ICAN-01	Interface card - 1x CAN interface (SJA1000) - For APC910/PPC900/APC3100/PPC3100	

##### 4.2.4.4.3 Technical data

### Information:

The following specified characteristic data, features and limit values are only valid for this accessory and may differ from those of the complete system. The data specified for the complete system applies to the complete system in which this accessory is installed, for example.

Order number	5AC901.ICAN-01
<b>General information</b>	
B&R ID code	0xD84C
Certifications	
CE	Yes
UL	cULus E115267 Industrial control equipment
HazLoc	cULus HazLoc E180196 Industrial control equipment for hazardous locations Class I, Division 2, Groups ABCD, T4 <sup>1)</sup>
EAC	Product family certification
<b>Interfaces</b>	
CAN	
Quantity	1
Controller	SJA1000
Variant	DSUB, 9-pin, male, galvanically isolated
Transfer rate	Max. 1 Mbit/s
Terminating resistor	
Type	Can be switched on and off with slide switch
Default setting	Off
<b>Electrical properties</b>	
Power consumption	0.5 W
<b>Operating conditions</b>	
Pollution degree per EN 61131-2	Pollution degree 2
<b>Ambient conditions</b>	
Temperature	
Operation	0 to 60°C <sup>2)</sup>
Storage	-20 to 60°C
Transport	-20 to 60°C
Relative humidity	
Operation	5 to 90%, non-condensing
Storage	5 to 95%, non-condensing
Transport	5 to 95%, non-condensing
<b>Mechanical properties</b>	
Weight	Approx. 33 g

- 1) Yes, but applies only if all components installed in the complete system have this certification and the complete system bears the corresponding mark.
- 2) For detailed information, see the temperature tables in the user's manual.



#### 4.2.4.4.3.1 Pinout

CAN bus	
Variant	DSUB, 9-pin, male
Galvanic isolation	Yes
Transfer rate	Max. 1 Mbit/s
Bus length	Max. 1000 meters
Pin	Pinout
1	NC. <sup>1)</sup>
2	CAN LOW
3	GND
4	NC.
5	NC.
6	Reserved
7	CAN HIGH
8	NC.
9	NC.

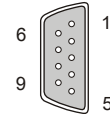

1) Not connected

#### 4.2.4.4.3.2 I/O address and IRQ

Resource	Default setting	Function
I/O address	384h (address register)	Defines the register number to be accessed.
	385h (data register)	Access to the register defined in the address register.
IRQ	IRQ10	Interrupt

1) Resource allocation is identical for the interface option 1 and 2 slots.

#### 4.2.4.4.3.3 CAN driver settings

The baud rate can be set either with predefined values or via the bit timing register. For additional information about CAN interfaces with AS/AR support, see Automation Help. For additional information about CAN interfaces without AS/AR support, see the user's manual for the B&R CAN driver at [www.br-automation.com](http://www.br-automation.com).

Bit timing register 0	Bit timing register 1	Baud rate
00h	14h	1000 kbit/s
80h or 00h	1Ch	500 kbit/s
81h or 01h	1Ch	250 kbit/s
83h or 03h	1Ch	125 kbit/s
84h or 04h	1Ch	100 kbit/s
89h or 09h	1Ch	50 kbit/s

#### 4.2.4.4.3.4 Cable data

For more detailed information about the transfer rate, bus length or cable requirements for the respective interfaces/buses, see "Cable data" on page 245.

#### 4.2.4.4.3.5 Terminating resistor

A terminating resistor for the CAN interface is already integrated in the IF option. This can be switched on or off with a switch (1); it is necessary to open the system unit for this. A switched-on terminating resistor is indicated by a yellow LED (2) (see "Reading LED status indicators" on page 244).

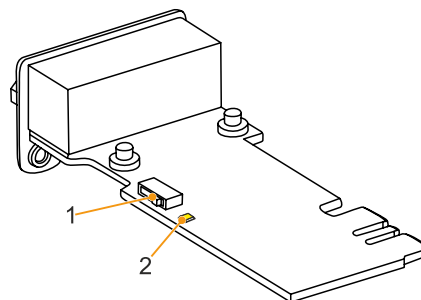

#### 4.2.4.4.4 Driver support

Drivers for approved operating systems are available for download in the Downloads section of the B&R website ([www.br-automation.com](http://www.br-automation.com)) (if required and not already included in the operating system).

Approved operating systems:

- B&R Linux
- Windows 10

### 4.2.4.5 5AC901.IHDA-00

#### 4.2.4.5.1 General information

Interface option 5AC901.IHDA-00 is equipped with an HDA sound chip with externally accessible MIC, Line IN and Line OUT channels.

- 1x MIC
- 1x Line IN
- 1x Line OUT
- Compatible with APC910/PPC900 and APC3100/PPC3100

This interface option can only be operated in slot IF option 1.

#### 4.2.4.5.2 Order data

Order number	Short description	Figure
5AC901.IHDA-00	Interface card - 1x audio interface (1x MIC / 1x Line In / 1x OUT) - For APC910/PPC900/APC3100/PPC3100	

#### 4.2.4.5.3 Technical data

### Information:

The following specified characteristic data, features and limit values are only valid for this accessory and may differ from those of the complete system. The data specified for the complete system applies to the complete system in which this accessory is installed, for example.

Order number	5AC901.IHDA-00
<b>General information</b>	
B&R ID code	0xD84E
Certifications	
CE	Yes
UL	cULus E115267 Industrial control equipment
HazLoc	cULus HazLoc E180196 Industrial control equipment for hazardous locations Class I, Division 2, Groups ABCD, T3C <sup>1)</sup>
DNV	Temperature: <b>B</b> (0 - 55°C) Humidity: <b>B</b> (up to 100%) Vibration: <b>A</b> (0.7 g) EMC: <b>B</b> (bridge and open deck) <sup>2)</sup>
EAC	Product family certification
<b>Interfaces</b>	
Audio	
Type	HDA sound
Controller	Realtek ALC 662
Inputs	Microphone, Line In
Outputs	Line Out
<b>Electrical properties</b>	
Power consumption	0.4 W
<b>Operating conditions</b>	
Pollution degree per EN 61131-2	Pollution degree 2
<b>Ambient conditions</b>	
Temperature	
Operation	0 to 55°C <sup>3)</sup>
Storage	-20 to 60°C
Transport	-20 to 60°C

## Technical data

<b>Order number</b>	<b>5AC901.IHDA-00</b>
Relative humidity	
Operation	5 to 90%, non-condensing
Storage	5 to 95%, non-condensing
Transport	5 to 95%, non-condensing
<b>Mechanical properties</b>	
Weight	Approx. 21 g

- 1) Yes, but applies only if all components installed in the complete system have this certification and the complete system bears the corresponding mark.
- 2) Yes, but applies only if all components installed in the complete system have this certification and are listed on the associated DNV certificate for the product family.
- 3) For detailed information, see the temperature tables in the user's manual.

### 4.2.4.5.3.1 Pinout

All interfaces are designed as 3.5-mm jack connections (female).

MIC, Line IN, Line OUT	
Controller	Realtek ALC 662
<b>MIC</b>	Microphone input (mono)
<b>Line IN</b>	Input (stereo)
<b>Line OUT</b>	Output (stereo) for playback devices (e.g. amplifiers)
-	

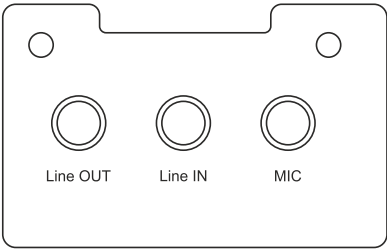

### 4.2.4.5.4 Drivers

A special driver is necessary to operate the audio controller. Drivers for approved operating systems are available for download in the Downloads section of the B&R website ([www.br-automation.com](http://www.br-automation.com)) (if required and not already included in the operating system).

#### **Information:**

**Necessary drivers must be downloaded from the B&R website, not from manufacturer websites.**

### 4.2.4.6 5AC901.ISRM-00

#### 4.2.4.6.1 General information

Interface option 5AC901.ISRM-00 is equipped with 2 MB SRAM.

- 2 MB SRAM
- Compatible with APC910/PPC900 and APC3100/PPC3100

This interface option can only be operated in slot IF option 2.

#### 4.2.4.6.2 Order data

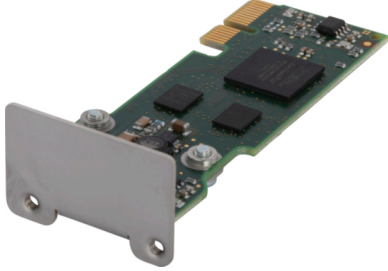
Order number	Short description	Figure
5AC901.ISRM-00	Interface card - 2 MB SRAM - For APC910/PPC900/APC3100/PPC3100	

#### 4.2.4.6.3 Technical data

### Information:

The following specified characteristic data, features and limit values are only valid for this accessory and may differ from those of the complete system. The data specified for the complete system applies to the complete system in which this accessory is installed, for example.

Order number	5AC901.ISRM-00
<b>General information</b>	
B&R ID code	0xD850
Certifications	
CE	Yes
UL	cULus E115267 Industrial control equipment
HazLoc	cULus HazLoc E180196 Industrial control equipment for hazardous locations Class I, Division 2, Groups ABCD, T4 <sup>1)</sup>
EAC	Product family certification
<b>Controller</b>	
SRAM	
Size	2 MB
Battery-backed	Yes
Remanent variables in power failure mode	256 kB (for e.g. Automation Runtime, see Automation Help)
<b>Electrical properties</b>	
Power consumption	2 W
<b>Operating conditions</b>	
Pollution degree per EN 61131-2	Pollution degree 2
<b>Ambient conditions</b>	
Temperature	
Operation	0 to 55°C <sup>2)</sup>
Storage	-20 to 60°C
Transport	-20 to 60°C
Relative humidity	
Operation	5 to 90%, non-condensing
Storage	5 to 95%, non-condensing
Transport	5 to 95%, non-condensing
<b>Mechanical properties</b>	
Weight	Approx. 20 g

- 1) Yes, but applies only if all components installed in the complete system have this certification and the complete system bears the corresponding mark.
- 2) For detailed information, see the temperature tables in the user's manual.

#### 4.2.4.6.4 Drivers

Drivers for approved operating systems are available for download in the Downloads section of the B&R website ([www.br-automation.com](http://www.br-automation.com)) (if required and not already included in the operating system).

Approved operating systems:

- Windows 10
- Automation Runtime

### 4.2.4.7 5AC901.IPLK-00

#### 4.2.4.7.1 General information

Interface option 5AC901.IPLK-00 is equipped with 1 POWERLINK interface and 2 MB SRAM.

- 1x POWERLINK interface managing or controlled node
- 2 MB SRAM
- Compatible with APC910/PPC900 and APC3100/PPC3100

This interface option can only be operated in the IF option 2 slot and is only supported by Automation Runtime.

#### 4.2.4.7.2 Order data

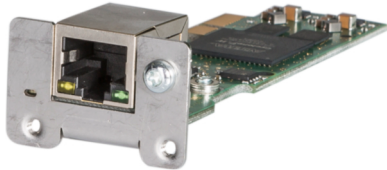
Order number	Short description	Figure
5AC901.IPLK-00	Interface options Interface card - 1x POWERLINK interface - 2 MB SRAM - For APC910/PPC900/APC3100/PPC3100	

#### 4.2.4.7.3 Technical data

### Information:

The following specified characteristic data, features and limit values are only valid for this accessory and may differ from those of the complete system. The data specified for the complete system applies to the complete system in which this accessory is installed, for example.

Order number	5AC901.IPLK-00
<b>General information</b>	
B&R ID code	0xE025
Diagnostics	
Data transfer	Yes, using LED status indicator
Certifications	
CE	Yes
UL	cULus E115267 Industrial control equipment
HazLoc	cULus HazLoc E180196 Industrial control equipment for hazardous locations Class I, Division 2, Groups ABCD, T4 <sup>1)</sup>
DNV	Temperature: <b>B</b> (0 - 55°C) Humidity: <b>B</b> (up to 100%) Vibration: <b>A</b> (0.7 g) EMC: <b>B</b> (bridge and open deck) <sup>2)</sup>
EAC	Product family certification
<b>Controller</b>	
SRAM	
Size	2 MB
Battery-backed	Yes
Remanent variables in power failure mode	256 kB (for e.g. Automation Runtime, see Automation Help)
<b>Interfaces</b>	
POWERLINK	
Quantity	1
Type	Type 4 <sup>3)</sup>
Variant	RJ45, shielded
Transfer rate	100 Mbit/s
Transfer	100BASE-TX
Line length	Max. 100 m between two stations (segment length)
<b>Electrical properties</b>	
Power consumption	1.5 W
<b>Operating conditions</b>	
Pollution degree per EN 61131-2	Pollution degree 2
<b>Ambient conditions</b>	
Temperature	
Operation	0 to 55°C <sup>4)</sup>
Storage	-20 to 60°C
Transport	-20 to 60°C

## Technical data

<b>Order number</b>	<b>5AC901.IPLK-00</b>
Relative humidity	
Operation	5 to 90%, non-condensing
Storage	5 to 95%, non-condensing
Transport	5 to 95%, non-condensing
<b>Mechanical properties</b>	
Weight	Approx. 35 g

- 1) Yes, but applies only if all components installed in the complete system have this certification and the complete system bears the corresponding mark.
- 2) Yes, but applies only if all components installed in the complete system have this certification and are listed on the associated DNV certificate for the product family.
- 3) For additional information, see Automation Help (Communication - POWERLINK - General information - Hardware - IF / LS).
- 4) For detailed information, see the temperature tables in the user's manual.

### 4.2.4.7.3.1 Pinout

POWERLINK		
Variant	RJ45, female	
Wiring	S/STP (Cat 5e)	
Cable length	Max. 100 m (min. Cat 5e)	
<b>LED "Link" (a)</b>	<b>On</b>	<b>Active</b>
Orange (light)	Link (a connection to a POWERLINK network exists)	Blinking (data being transferred)
<b>(b)</b>	-	
<b>LED "Status/Error" (c)</b>	<b>On</b>	<b>Off</b>
Green/Red	POWERLINK status see "LED "S/E" (status/error LED)" on page 247	
	-	

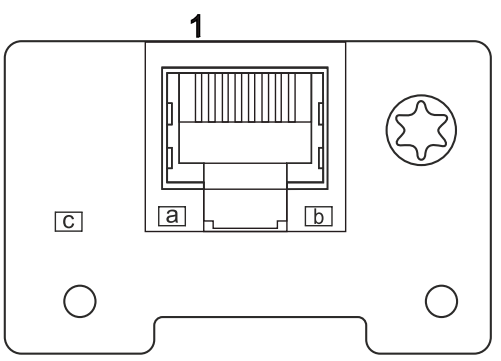

### 4.2.4.7.3.2 POWERLINK commissioning and operation

For a description of the operating modes, status and node numbers of the POWERLINK interface(s), see ["LED "S/E" \(status/error LED\)" on page 247](#).

### 4.2.4.7.4 Driver support and firmware update

The driver is part of the Automation Runtime and the firmware is part of Automation Studio. The module is automatically brought up to this level.

To update the firmware contained in Automation Studio, a hardware upgrade must be performed (see **Project management / Workspace / Upgrades** in Automation Help).



### 4.2.4.8 5AC901.IRDY-00

#### 4.2.4.8.1 General information

Ready relay 5AC901.IRDY-00 is switched as soon as the B&R industrial PC has started up and all internal supply voltages are applied. It is possible to connect additional devices to the ready relay; they will also be switched on when the B&R industrial PC starts up.

- 1 normally closed contact, 1 normally open contact
- Compatible with APC910/PPC900 and APC3100/PPC3100

Terminal block 0TB2104.8000 is not included in delivery and must be ordered separately.

#### 4.2.4.8.2 Order data

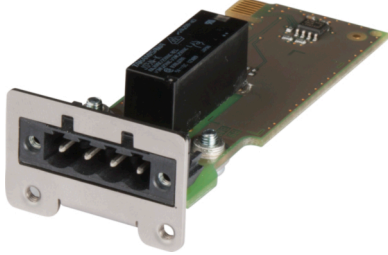
Order number	Short description	Figure
	<b>Interface options</b>	
5AC901.IRDY-00	Interface card - Ready relay - For APC910/PPC900/APC3100/PPC3100	
	<b>Required accessories</b>	
	<b>Terminal blocks</b>	
0TB2104.8000	Connector 24 VDC - 4-pin female - Screw clamp terminal block 2.5 mm <sup>2</sup>	

#### 4.2.4.8.3 Technical data

### Information:

The following specified characteristic data, features and limit values are only valid for this accessory and may differ from those of the complete system. The data specified for the complete system applies to the complete system in which this accessory is installed, for example.

Order number	5AC901.IRDY-00
<b>General information</b>	
B&R ID code	0xD84F
Ready relay	Normally open contact and normally closed contact, max. 30 VDC, max. 2 A
Certifications	
CE	Yes
UL	cULus E115267 Industrial control equipment
EAC	Product family certification
<b>Electrical properties</b>	
Power consumption	0.2 W
<b>Operating conditions</b>	
Pollution degree per EN 61131-2	Pollution degree 2
<b>Ambient conditions</b>	
Temperature	
Operation	0 to 60°C <sup>1)</sup>
Storage	-20 to 60°C
Transport	-20 to 60°C
Relative humidity	
Operation	5 to 90%, non-condensing
Storage	5 to 95%, non-condensing
Transport	5 to 95%, non-condensing
<b>Mechanical properties</b>	
Weight	Approx. 30 g

1) For detailed information, see the temperature tables in the user's manual.

#### 4.2.4.8.3.1 Pinout

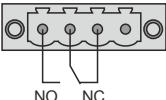
Ready relay			Connector, 4-pin, male
Pin	Pinout	Description	
1	NO	Normally open contact	
2	COM	Changeover contact	
3	NC	Normally closed contact	
4	-	Not connected	

### 4.2.4.9 5AC901.ISIO-00

#### 4.2.4.9.1 General information

The ready relay function of IF option 5AC901.ISIO-00 can be controlled using the MTCX. Corresponding commands must be issued by the MTCX in order to switch the ready relay.

In addition to the ready relay function, the reset and power button as well as the power LED of the APC910/PPC900 or APC3100/PPC3100 can be routed externally.

- Connections for the reset button and power buttons on the PC
- Connection for LED "Power" on the PC
- 1 normally closed contact, 1 normally open contact of the ready relay
- Control of the ready relay functions using MTCX commands
- Compatible with APC910/PPC900 and APC3100/PPC3100

Unlike IF option 5AC901.IRDY-00, ready relay 5AC901.ISIO-00 is not automatically switched on or off if the power supply to the PC is switched on or off.

The maximum cable length for connecting the reset button, power button and LED "Power" is 2 m.

#### 4.2.4.9.2 Order data

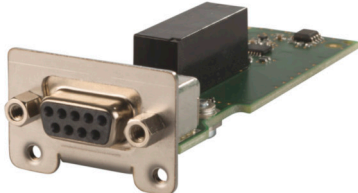
Order number	Short description	Figure
5AC901.ISIO-00	Interface card - System I/O - For APC910/PPC900/APC3100/PPC3100	

#### 4.2.4.9.3 Technical data

### Information:

The following specified characteristic data, features and limit values are only valid for this accessory and may differ from those of the complete system. The data specified for the complete system applies to the complete system in which this accessory is installed, for example.

Order number	5AC901.ISIO-00
<b>General information</b>	
B&R ID code	0xE674
Ready relay	Normally open contact and normally closed contact, max. 30 VDC, max. 1 A
<b>Certifications</b>	
CE	Yes
UL	cULus E115267 Industrial control equipment
DNV	Temperature: <b>B</b> (0 - 55°C) Humidity: <b>B</b> (up to 100%) Vibration: <b>A</b> (0.7 g) EMC: <b>B</b> (bridge and open deck) <sup>1)</sup>
EAC	Product family certification
<b>Electrical properties</b>	
Power consumption	0.5 W
<b>Operating conditions</b>	
Pollution degree per EN 61131-2	Pollution degree 2
<b>Ambient conditions</b>	
Temperature	
Operation	0 to 60°C <sup>2)</sup>
Storage	-20 to 60°C
Transport	-20 to 60°C

<b>Order number</b>	<b>5AC901.ISIO-00</b>
Relative humidity	
Operation	5 to 90%, non-condensing
Storage	5 to 95%, non-condensing
Transport	5 to 95%, non-condensing
<b>Mechanical properties</b>	
Weight	Approx. 30 g

- 1) Yes, but applies only if all components installed in the complete system have this certification and are listed on the associated DNV certificate for the product family.
- 2) For detailed information, see the temperature tables in the user's manual.

#### 4.2.4.9.3.1 Pinout

Ready relay	
Cable length	Max. 2 meters
Pin	Pinout
1	Output LED ("Power") - Green
2	Output LED ("Power") - Red
3	GND
4	Input - Power button
5	Input - Reset button
6	Relay, normally open contact
7	Relay, normally closed contact
8	GND
9	COM relay, changeover contact

DSUB, 9-pin, female

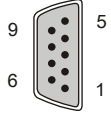

For information about LED "Power", see section ["LED status indicators" on page 44](#).

For information about the power and reset buttons, see section ["Power and reset buttons" on page 43](#).

#### 4.2.4.9.3.2 Connection example

### Information:

**Series resistors for the LEDs are already installed on the interface option.**

The LED outputs are dimensioned for a typical LED current of 3.5 mA.

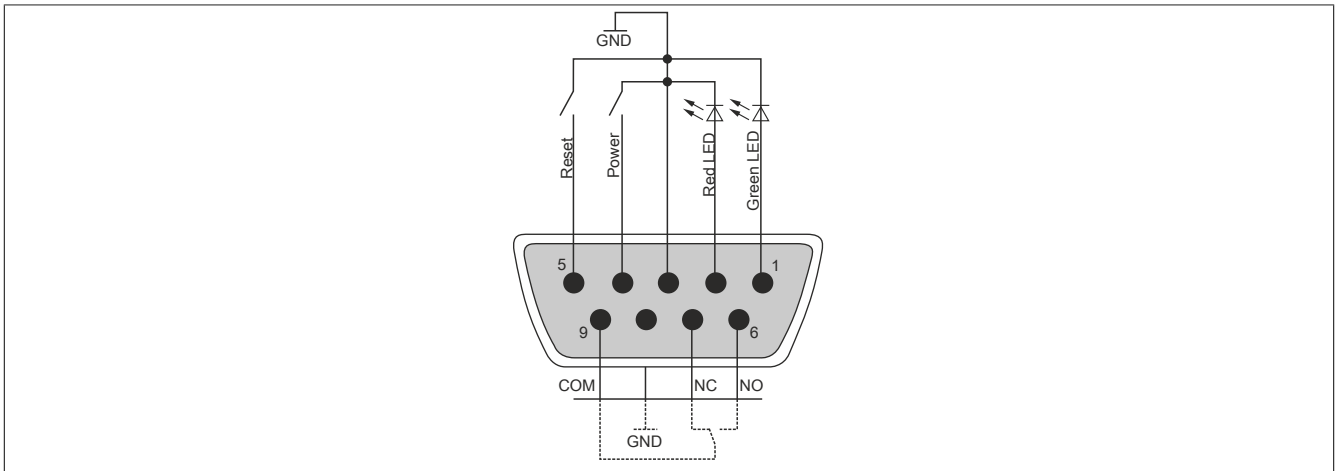

### 4.2.4.10 5AC901.IETH-00

#### 4.2.4.10.1 General information

Interface option 5AC901.IETH-00 is equipped with a 10/100/1000BASE-T Ethernet interface.

- 1x Ethernet interface 10/100/1000BASE-T
- Compatible with APC910/PPC900 and APC3100/PPC3100

This interface option can only be operated in slot IF option 2.

#### 4.2.4.10.2 Order data

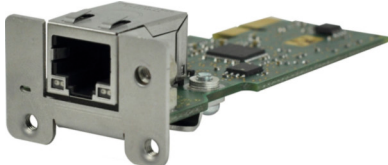
Order number	Short description	Figure
	<b>Interface options</b>	
5AC901.IETH-00	Interface card - 1x ETH 10/100/1000 - For APC910/PPC900/ APC3100/PPC3100	

#### 4.2.4.10.3 Technical data

### Information:

The following specified characteristic data, features and limit values are only valid for these individual components and may differ from those of the complete system. The data specified for the complete system applies to the complete system in which this individual component is used, for example.

Order number	5AC901.IETH-00
<b>General information</b>	
B&R ID code	EC3C
Diagnostics	
Data transfer	Yes, using LED status indicator
<b>Certifications</b>	
CE	Yes
UL	cULus E115267 Industrial control equipment
DNV	Temperature: <b>B</b> (0 - 55°C) Humidity: <b>B</b> (up to 100%) Vibration: <b>A</b> (0.7 g) EMC: <b>B</b> (bridge and open deck) <sup>1)</sup>
EAC	Product family certification
<b>Interfaces</b>	
Ethernet	
Quantity	1
Controller	Intel I210
Variant	RJ45, shielded
Transfer rate	10/100/1000 Mbit/s <sup>2)</sup>
Line length	Max. 100 m between two stations (segment length)
<b>Electrical properties</b>	
Power consumption	1 W
<b>Operating conditions</b>	
Pollution degree per EN 61131-2	Pollution degree 2
<b>Ambient conditions</b>	
Temperature	
Operation	0 to 55°C <sup>3)</sup>
Storage	-20 to 60°C
Transport	-20 to 60°C
Relative humidity	
Operation	5 to 90%, non-condensing
Storage	5 to 95%, non-condensing
Transport	5 to 95%, non-condensing
<b>Mechanical properties</b>	
Weight	Approx. 35 g

1) Yes, but applies only if all components installed in the complete system have this certification and are listed on the associated DNV certificate for the product family.

2) Switching takes place automatically.

3) For detailed information, see the temperature tables in the user's manual.

### 4.2.4.10.3.1 Pinout

Ethernet interface (ETH <sup>1)</sup> )		
Variant	RJ45, female	
Controller	Intel I210	
Wiring	S/STP (Cat 5e)	
Transfer rate	10/100/1000 Mbit/s <sup>2)</sup>	
Cable length	Max. 100 m (min. Cat 5e)	
<b>LED "Speed" (a)</b>	<b>On</b>	<b>Off</b>
Green	100 Mbit/s	10 Mbit/s <sup>3)</sup>
Orange (light)	1000 Mbit/s	-
<b>LED "Link" (b)</b>	<b>On</b>	<b>Active</b>
Orange (light)	Link (a connection to an Ethernet network exists)	Blinking (data being transferred)

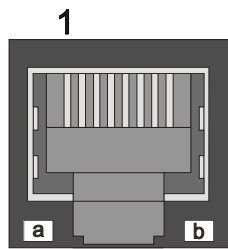

- 1) The interfaces, etc. available on the device or module have been numbered for the purpose of clear differentiation. This numbering may deviate from the numbering used by the respective operating system, however.
- 2) Switching takes place automatically.
- 3) The 10 Mbit/s transfer rate / connection is only available if LED "Link" is active at the same time.

### 4.2.4.10.4 Driver support

Drivers for approved operating systems are available for download in the Downloads section of the B&R website ([www.br-automation.com](http://www.br-automation.com)) (if required and not already included in the operating system).

Approved operating systems:

- B&R Linux
- Windows 10

#### Information:

**Necessary drivers must be downloaded from the B&R website, not from manufacturer websites.**

Wake-on-LAN (WoL) and PXE boot are not supported.

### 4.2.4.11 5ACCIF02.CANE-000

#### 4.2.4.11.1 General information

Interface option 5ACCIF02.CANE-000 has a 10/100/1000BASE-T Ethernet interface and a CAN bus master interface.

- 1x Ethernet interface 10/100/1000BASE-T
- 1x CAN bus master interface (SJA1000)
- Compatible with APC3100/PPC3100

This interface option can only be operated in slot IF option 2 and additionally uses slot IF option 2 add-on.

Simultaneous operation of 2 interface options with a legacy CAN interface in slots IF option 1 and IF option 2 is not possible.

#### 4.2.4.11.2 Order data

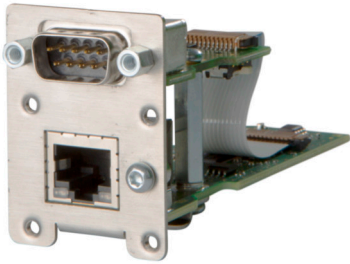
Order number	Short description	Figure
5ACCIF02.CANE-000	Interface options Interface card - 1x CAN interface (SJA1000) - 1x ETH 10/100/1000 - For APC3100/PPC3100	

#### 4.2.4.11.3 Technical data

### Information:

The following specified characteristic data, features and limit values are only valid for this accessory and may differ from those of the complete system. The data specified for the complete system applies to the complete system in which this accessory is installed, for example.

Order number	5ACCIF02.CANE-000
<b>General information</b>	
B&R ID code	0xF171
Diagnostics	
Data transfer	Yes, using LED status indicator
Certifications	
CE	Yes
UL	cULus E115267
EAC	Industrial control equipment Product family certification
<b>Interfaces</b>	
Ethernet	
Quantity	1
Controller	Intel I210
Variant	RJ45, shielded
Transfer rate	10/100/1000 Mbit/s <sup>1)</sup>
Line length	Max. 100 m between two stations (segment length)
CAN	
Quantity	1
Controller	SJA1000
Variant	DSUB, 9-pin, male, galvanically isolated
Transfer rate	Max. 1 Mbit/s
Terminating resistor	
Type	Can be switched on and off with slide switch
Default setting	Off
<b>Electrical properties</b>	
Power consumption	1.5 W
<b>Operating conditions</b>	
Pollution degree per EN 61131-2	Pollution degree 2

<b>Order number</b>	<b>5ACCIF02.CANE-000</b>
<b>Ambient conditions</b>	
Temperature	
Operation	0 to 55°C <sup>2)</sup>
Storage	-20 to 60°C
Transport	-20 to 60°C
Relative humidity	
Operation	5 to 90%, non-condensing
Storage	5 to 95%, non-condensing
Transport	5 to 95%, non-condensing
<b>Mechanical properties</b>	
Weight	Approx. 100 g

- 1) Switching takes place automatically.
- 2) For detailed information, see the temperature tables in the user's manual.

#### 4.2.4.11.3.1 ETH - Pinout

The Ethernet interface is available in the IF option 2 slot.

Ethernet interface (ETH <sup>1)</sup> )		
Variant	RJ45, female	
Controller	Intel I210	
Wiring	S/STP (Cat 5e)	
Transfer rate	10/100/1000 Mbit/s <sup>2)</sup>	
Cable length	Max. 100 m (min. Cat 5e)	
<b>LED "Speed" (a)</b>	<b>On</b>	<b>Off</b>
Green	100 Mbit/s	10 Mbit/s <sup>3)</sup>
Orange (light)	1000 Mbit/s	-
<b>LED "Link" (b)</b>	<b>On</b>	<b>Active</b>
Orange (light)	Link (a connection to an Ethernet network exists)	Blinking (data being transferred)

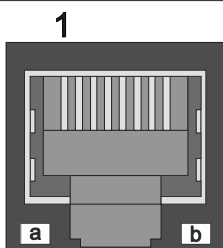

- 1) The interfaces, etc. available on the device or module have been numbered for the purpose of clear differentiation. This numbering may deviate from the numbering used by the respective operating system, however.
- 2) Switching takes place automatically.
- 3) The 10 Mbit/s transfer rate / connection is only available if LED "Link" is active at the same time.

### 4.2.4.11.3.2 CAN - Pinout

The CAN interface is available in the IF option 2 add-on slot.

CAN bus <sup>1)</sup>	
Variant	DSUB, 9-pin, male
Galvanic isolation	Yes
Transfer rate	Max. 1 Mbit/s
Bus length	Max. 1000 meters
Pin	Pinout
1	NC. <sup>2)</sup>
2	CAN LOW
3	GND
4	NC.
5	NC.
6	Reserved
7	CAN HIGH
8	NC.
9	NC.

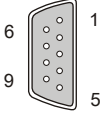

- 1) The interfaces, etc. available on the device or module have been numbered for the purpose of clear differentiation. This numbering may deviate from the numbering used by the respective operating system, however.
- 2) Not connected

### I/O address and IRQ

Resource	Default setting	Function
I/O address	384h (address register)	Defines the register number to be accessed.
	385h (data register)	Access to the register defined in the address register.
IRQ	IRQ10	Interrupt

### CAN driver settings

The baud rate can be set either with predefined values or via the bit timing register.

For additional information about CAN interfaces with AS/AR support, see Automation Help. For additional information about CAN interfaces without AS/AR support, see the user's manual for the B&R CAN driver at [www.br-automation.com](http://www.br-automation.com).

Bit timing register 0	Bit timing register 1	Baud rate
00h	14h	1000 kbit/s
80h or 00h	1Ch	500 kbit/s
81h or 01h	1Ch	250 kbit/s
83h or 03h	1Ch	125 kbit/s
84h or 04h	1Ch	100 kbit/s
89h or 09h	1Ch	50 kbit/s

### Cable data

For more detailed information about the transfer rate, bus length or cable requirements for the respective interfaces/buses, see "Cable data" on page 245.



## Terminating resistor

A terminating resistor for the CAN interface is already integrated in the IF option. This can be switched on or off with a switch (1); it is necessary to open the system unit for this. A switched-on terminating resistor is indicated by a yellow LED (2) (see "Reading LED status indicators" on page 244).

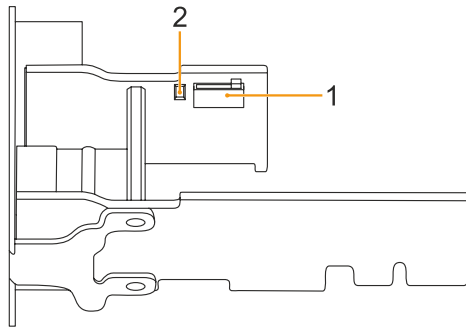

### 4.2.4.11.4 Driver support

Drivers for approved operating systems are available for download in the Downloads section of the B&R website ([www.br-automation.com](http://www.br-automation.com)) (if required and not already included in the operating system).

Approved operating systems:

- B&R Linux
- Windows 10

### **Information:**

**Necessary drivers must be downloaded from the B&R website, not from manufacturer websites.**

Wake-on-LAN (WoL) and PXE boot are not supported.

#### 4.2.4.12 5ACCIF02.FPLK-000

##### 4.2.4.12.1 General information

Interface option 5ACCIF02.FPLK-000 is equipped with 2 female RJ45 connectors connected to an integrated POWERLINK hub. 2 MB SRAM is also installed.

With the integrated 2-port hub, a simple tree structure, daisy chain wiring or optional ring redundancy can be easily implemented without additional effort.

With poll-response chaining (PRC), the IF option offers a solution for the highest demands on response time and the shortest cycle times. When combined with the B&R control system, poll-response chaining provides ideal performance, particularly for central control tasks.

### Information:

**Ring redundancy and simultaneous poll-response chaining operation is not possible with this IF option.**

- 1x POWERLINK interface for real-time communication
- 2 MB SRAM
- Integrated hub for economical wiring
- Configurable ring redundancy
- Poll-response chaining
- Compatible with APC3100/PPC3100

This interface option can only be operated in slot IF option 2, additionally uses slot IF option 2 add-on and is only supported by Automation Runtime.

##### 4.2.4.12.2 Order data

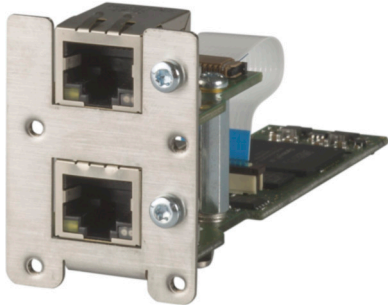
Order number	Short description	Figure
	<b>Interface options</b>	
5ACCIF02.FPLK-000	Interface card - 1x POWERLINK interface - 2 MB SRAM - Integrated 2-port hub - Ring redundancy - POWERLINK managing or controlled node - PRC function - For APC3100/PPC3100	

##### 4.2.4.12.3 Technical data

### Information:

The following specified characteristic data, features and limit values are only valid for this accessory and may differ from those of the complete system. The data specified for the complete system applies to the complete system in which this accessory is installed, for example.

Order number	5ACCIF02.FPLK-000
<b>General information</b>	
B&R ID code	0xF10E
<b>Certifications</b>	
CE	Yes
UL	cULus E115267 Industrial control equipment
EAC	Product family certification
<b>Controller</b>	
<b>SRAM</b>	
Size	2 MB
Battery-backed	Yes
Remanent variables in power failure mode	256 kB (for e.g. Automation Runtime, see Automation Help)

<b>Order number</b>	<b>5ACCIF02.FPLK-000</b>
<b>Interfaces</b>	
POWERLINK	
Quantity	1 (integrated 2-port hub)
Type	Type 4, redundant <sup>1)</sup>
Variant	RJ45, shielded
Transfer rate	100 Mbit/s
Transfer	100BASE-TX
Line length	Max. 100 m between two stations (segment length)
<b>Electrical properties</b>	
Power consumption	2 W
<b>Operating conditions</b>	
Pollution degree per EN 61131-2	Pollution degree 2
<b>Ambient conditions</b>	
Temperature	
Operation	0 to 55°C <sup>2)</sup>
Storage	-20 to 60°C
Transport	-20 to 60°C
Relative humidity	
Operation	5 to 90%, non-condensing
Storage	5 to 95%, non-condensing
Transport	5 to 95%, non-condensing
<b>Mechanical properties</b>	
Weight	Approx. 100 g

- 1) For additional information, see Automation Help (Communication - POWERLINK - General - Hardware - IF / LS).  
 2) For detailed information, see the temperature tables in the user's manual.

#### 4.2.4.12.3.1 POWERLINK 1 interface - Pinout

The POWERLINK 1 interface is available in the IF option 2 slot.

POWERLINK 1 - IF1 <sup>1)</sup>		
Variant	RJ45, female	
Wiring	S/STP (Cat 5e)	
Cable length	Max. 100 m (min. Cat 5e)	
<b>LED "Link" (a)</b>	<b>On</b>	<b>Active</b>
Orange (light)	Link (a connection to a POWERLINK network exists)	Blinking (data being transferred)
<b>LED "Status" (b)</b>	<b>On</b>	<b>Off</b>
Green/Red	POWERLINK status see "LED "S/E" (status/error LED)" on page 247	

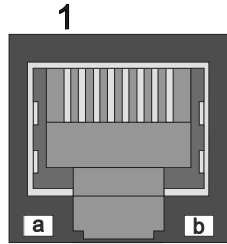

- 1) The interfaces, etc. available on the device or module have been numbered for the purpose of clear differentiation. This numbering may deviate from the numbering used by the respective operating system, however.

#### 4.2.4.12.3.2 POWERLINK 2 interface - Pinout

The POWERLINK 2 interface is available in the IF option 2 add-on slot.

POWERLINK 2 - IF2 <sup>1)</sup>		
Variant	RJ45, female	
Wiring	S/STP (Cat 5e)	
Cable length	Max. 100 m (min. Cat 5e)	
<b>LED "Link" (a)</b>	<b>On</b>	<b>Active</b>
Orange (light)	Link (a connection to a POWERLINK network exists)	Blinking (data being transferred)
<b>LED "Status" (b)</b>	<b>On</b>	<b>Off</b>
Green/Red	POWERLINK status see "LED "S/E" (status/error LED)" on page 247	

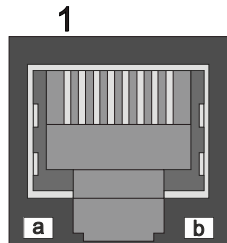

- 1) The interfaces, etc. available on the device or module have been numbered for the purpose of clear differentiation. This numbering may deviate from the numbering used by the respective operating system, however.

#### 4.2.4.12.3.3 POWERLINK commissioning and operation

For a description of the operating modes, status and node numbers of the POWERLINK interface(s), see "LED "S/E" (status/error LED)" on page 247.

#### 4.2.4.12.4 Driver support and firmware update

The driver is part of the Automation Runtime and the firmware is part of Automation Studio. The module is automatically brought up to this level.

To update the firmware contained in Automation Studio, a hardware upgrade must be performed (see **Project management / Workspace / Upgrades** in Automation Help).

### 4.2.4.13 5ACCIF02.FPLS-000

#### 4.2.4.13.1 General information

Interface option 5ACCIF02.FPLS-000 is equipped with a POWERLINK and RS232 interface. In addition, 2 MB SRAM is installed.

- 1x POWERLINK interface managing or controlled node
- 1x RS232 interface
- 2 MB SRAM
- Compatible with APC3100, PPC3100

This interface option can only be operated in slot IF option 2 and additionally uses slot IF option 2 add-on.

#### 4.2.4.13.2 Order data

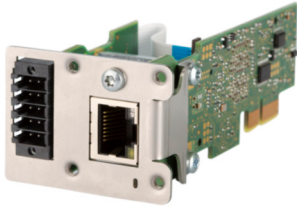
Order number	Short description	Figure
5ACCIF02.FPLS-000	Interface card - 2 MB SRAM - 1x RS232 interface - 1x POWER-LINK interface - For APC3100/PPC3100	

#### 4.2.4.13.3 Technical data

### Information:

The following specified characteristic data, features and limit values are only valid for this accessory and may differ from those of the complete system. The data specified for the complete system applies to the complete system in which this accessory is installed, for example.

Order number	5ACCIF02.FPLS-000
<b>General information</b>	
B&R ID code	0xF2E2
Diagnostics	
Data transfer	Yes, using LED "Status/Error"
Certifications	
CE	Yes
UL	cULus E115267 Industrial control equipment
<b>Controller</b>	
SRAM	
Size	2 MB
Battery-backed	Yes
Remanent variables in power failure mode	256 kB (for e.g. Automation Runtime, see Automation Help)
<b>Interfaces</b>	
COM	
Quantity	1
Type	RS232, modem supported, not galvanically isolated
Variant	10-pin, male
UART	16550-compatible, 16-byte FIFO buffer
Max. baud rate	115 kbit/s
POWERLINK	
Quantity	1
Type	Type 4 <sup>1)</sup>
Variant	RJ45, shielded
Transfer rate	100 Mbit/s
Transfer	100BASE-TX
Line length	Max. 100 m between two stations (segment length)
<b>Electrical properties</b>	
Power consumption	1.75 W
<b>Operating conditions</b>	
Pollution degree per EN 61131-2	Pollution degree 2
<b>Ambient conditions</b>	
Temperature	
Operation	0 to 55°C <sup>2)</sup>
Storage	-20 to 60°C
Transport	-20 to 60°C

## Technical data

<b>Order number</b>	<b>5ACCIF02.FPLS-000</b>
Relative humidity	
Operation	5 to 90%, non-condensing
Storage	5 to 95%, non-condensing
Transport	5 to 95%, non-condensing
<b>Mechanical properties</b>	
Weight	Approx. 100 g

- 1) For additional information, see Automation Help (Communication - POWERLINK - General - Hardware - IF / LS).
- 2) For detailed information, see the temperature tables in the user's manual.

### 4.2.4.13.3.1 POWERLINK interface - Pinout

The POWERLINK interface is available in the IF option 2 slot.

POWERLINK <sup>1)</sup>		
Variant	RJ45, female	
Wiring	S/STP (Cat 5e)	
Cable length	Max. 100 m (min. Cat 5e)	
<b>LED "Link" (a)</b>	<b>On</b>	<b>Active</b>
Orange (light)	Link (a connection to a POWERLINK network exists)	Blinking (data being transferred)
<b>LED "Status" (b)</b>	<b>On</b>	<b>Off</b>
Green/Red	POWERLINK status "LED "S/E" (status/error LED)" on page 247	

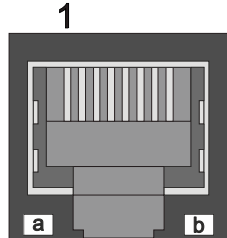

- 1) The interfaces, etc. available on the device or module have been numbered for the purpose of clear differentiation. This numbering may deviate from the numbering used by the respective operating system, however.

### POWERLINK commissioning and operation

For a description of the operating modes, status and node numbers of the POWERLINK interface(s), see "LED "S/E" (status/error LED)" on page 247.

### 4.2.4.13.3.2 Serial interface COM D - Pinout

Serial interface COM D is available in the IF option 2 add-on slot.

Serial interface COM D <sup>1)2)</sup>	
RS232	
Variant	10-pin, male
Type	RS232, modem supported
UART	16550-compatible, 16-byte FIFO buffer
Galvanic isolation	No
Transfer rate	Max. 115 kbit/s
Bus length	Max. 15 m
<b>Pin</b>	<b>Pinout</b>
1	DCD
2	DSR
3	RXD
4	RTS
5	TXD
6	CTS
7	DTR
8	RI
9	GND
10	Shield

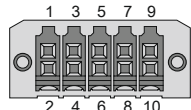

- 1) The interfaces, etc. available on the device or module have been numbered for the purpose of clear differentiation. This numbering may deviate from the numbering used by the respective operating system, however.
- 2) This interface (if available) is automatically enabled in BIOS as COM D with default addresses I/O:338h and IRQ:7. The respective default values for the I/O address and IRQ can be modified in BIOS.

### Cable data

For more detailed information about the transfer rate, bus length or cable requirements for the respective interfaces/buses, see "Cable data" on page 245.

#### 4.2.4.13.4 Shielding

For the interfaces on the 10-pin female connector, the shield of the interfaces can be connected to pin *Shield* (pin 2) of the female connector.

In addition, there is a functional ground connection on the interface cover of the system unit that can also be used for the cable shields.

#### 4.2.4.13.5 Driver support and firmware update

Drivers for approved operating systems are available for download in the Downloads section of the B&R website ([www.br-automation.com](http://www.br-automation.com)) (if required and not already included in the operating system).

Approved operating systems:

- Automation Runtime
- B&R Linux
- Windows 10

#### Automation Runtime / B&R Hypervisor (RTOS)

The driver is part of the Automation Runtime and the firmware is part of Automation Studio. The module is automatically brought up to this level.

To update the firmware contained in Automation Studio, a hardware upgrade must be performed (see **Project management / Workspace / Upgrades** in Automation Help).

All interfaces of the interface option are supported in Automation Runtime / B&R Hypervisor.

#### General purpose operating system (GPOS)

If this interface option is used with a GPOS, only operation of the serial port(s) is supported and the firmware update function cannot be used.

#### 4.2.4.14 5ACCIF02.FPSC-000

##### 4.2.4.14.1 General information

Interface option 5ACCIF02.FPSC-000 is equipped with a POWERLINK, RS232 and CAN bus master as well as an X2X Link master interface. In addition, 2 MB SRAM is installed.

- 1x POWERLINK interface managing or controlled node
- 1x CAN bus master interface
- 1x X2X Link master interface
- 1x RS232 interface
- 2 MB SRAM
- Compatible with APC3100, PPC3100

This interface option can only be operated in slot IF option 2, additionally uses slot IF option 2 add-on and is only supported by Automation Runtime.

##### 4.2.4.14.2 Order data

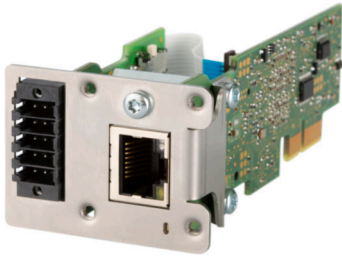
Order number	Short description	Figure
	<b>Interface options</b>	
5ACCIF02.FPSC-000	Interface card - 2 MB SRAM - 1x RS232 interface - 1x CAN interface - 1x POWERLINK interface - 1x X2X - For APC3100/PPC3100	

##### 4.2.4.14.3 Technical data

### Information:

The following specified characteristic data, features and limit values are only valid for this accessory and may differ from those of the complete system. The data specified for the complete system applies to the complete system in which this accessory is installed, for example.

Order number	5ACCIF02.FPSC-000
<b>General information</b>	
B&R ID code	0xF2E3
Diagnostics	
Data transfer	Yes, using LED "Status/Error"
<b>Certifications</b>	
CE	Yes
UL	cULus E115267 Industrial control equipment
EAC	Product family certification
<b>Controller</b>	
SRAM	
Size	2 MB
Battery-backed	Yes
Remanent variables in power failure mode	256 kB (e.g. for Automation Runtime, see Automation Help)
<b>Interfaces</b>	
COM	
Quantity	1
Type	RS232, modem not supported, not galvanically isolated
Variant	10-pin, male
UART	16550-compatible, 16-byte FIFO
Max. baud rate	115 kbit/s
POWERLINK	
Quantity	1
Type	Type 4 <sup>1)</sup>
Variant	RJ45, shielded
Transfer rate	100 Mbit/s
Transfer	100BASE-TX
Line length	Max. 100 m between two stations (segment length)



<b>Order number</b>	<b>5ACCIF02.FPSC-000</b>
CAN	
Quantity	1
Variant	10-pin, male, galvanically isolated
Transfer rate	Max. 1 Mbit/s
Terminating resistor	
Type	Can be switched on and off with slide switch
Default setting	Off
X2X	
Type	X2X Link master
Quantity	1
Variant	10-pin, male, galvanically isolated
<b>Electrical properties</b>	
Power consumption	2 W
<b>Operating conditions</b>	
Pollution degree per EN 61131-2	Pollution degree 2
<b>Ambient conditions</b>	
Temperature	
Operation	0 to 55°C <sup>2)</sup>
Storage	-20 to 60°C
Transport	-20 to 60°C
Relative humidity	
Operation	5 to 90%, non-condensing
Storage	5 to 95%, non-condensing
Transport	5 to 95%, non-condensing
<b>Mechanical properties</b>	
Weight	Approx. 100 g

- 1) For additional information, see Automation Help (Communication - POWERLINK - General - Hardware - IF / LS).  
 2) For detailed information, see the temperature tables in the user's manual.

#### 4.2.4.14.3.1 POWERLINK interface - Pinout

The POWERLINK interface is available in the IF option 2 slot.

POWERLINK <sup>1)</sup>		
Variant	RJ45, female	
Wiring	S/STP (Cat 5e)	
Cable length	Max. 100 m (min. Cat 5e)	
<b>LED "Link" (a)</b>	<b>On</b>	<b>Active</b>
Orange (light)	Link (a connection to a POWERLINK network exists)	Blinking (data being transferred)
<b>LED "Status" (b)</b>	<b>On</b>	<b>Off</b>
Green/Red	POWERLINK status "LED "S/E" (status/error LED)" on page 247	

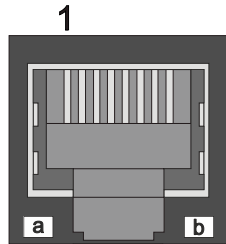

The diagram shows a 10-pin RJ45 connector. Above the connector is the number '1'. Below the connector are two LEDs labeled 'a' and 'b'.

- 1) The interfaces, etc. available on the device or module have been numbered for the purpose of clear differentiation. This numbering may deviate from the numbering used by the respective operating system, however.

#### POWERLINK commissioning and operation

For a description of the operating modes, status and node numbers of the POWERLINK interface(s), see "LED "S/E" (status/error LED)" on page 247.

### 4.2.4.14.3.2 Serial interface COM - Pinout

Serial interface COM is available in the IF option 2 add-on slot.

Serial interface COM <sup>1)2)</sup>	
RS232	
Variant	10-pin, male
Type	RS232, not modem supported
UART	16550-compatible, 16-byte FIFO buffer
Galvanic isolation	No
Transfer rate	Max. 115 kbit/s
Bus length	Max. 15 m
Pin	Pinout
1	-
2	Shield
3	-
4	-
5	-
6	-
7	-
8	COM GND
9	RXD
10	TXD

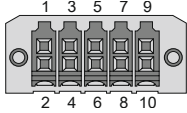

- 1) The interfaces, etc. available on the device or module have been numbered for the purpose of clear differentiation. This numbering may deviate from the numbering used by the respective operating system, however.
- 2) This interface can only be used in Automation Runtime and is displayed as IF5 in Automation Studio / Automation Runtime. It is not a "PC interface" and therefore not displayed in BIOS.

### Cable data

For more detailed information about the transfer rate, bus length or cable requirements for the respective interfaces/buses, see "Cable data" on page 245.

### 4.2.4.14.3.3 CAN bus interface - Pinout

The CAN bus interface is available in the IF option 2 add-on slot.

CAN bus <sup>1)2)</sup>	
Variant	10-pin, male
Galvanic isolation	Yes
Transfer rate	Max. 1 Mbit/s
Bus length	Max. 1000 m
Pin	Pinout
1	-
2	Shield
3	-
4	-
5	CAN H
6	CAN L
7	CAN GND
8	-
9	-
10	-

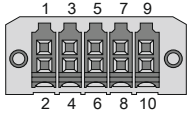

- 1) The interfaces, etc. available on the device or module have been numbered for the purpose of clear differentiation. This numbering may deviate from the numbering used by the respective operating system, however.
- 2) This interface can only be used in Automation Runtime and is displayed as IF3 in Automation Studio / Automation Runtime. It is not a "PC interface" and therefore not displayed in BIOS.

### CAN driver settings

The baud rate can be set either with predefined values or via the bit timing register.

For additional information about CAN interfaces with AS/AR support, see Automation Help. For additional information about CAN interfaces without AS/AR support, see the user's manual for the B&R CAN driver at [www.br-automation.com](http://www.br-automation.com).

Bit timing register 0	Bit timing register 1	Baud rate
00h	14h	1000 kbit/s
80h or 00h	1Ch	500 kbit/s
81h or 01h	1Ch	250 kbit/s
83h or 03h	1Ch	125 kbit/s
84h or 04h	1Ch	100 kbit/s
89h or 09h	1Ch	50 kbit/s

### **Cable data**

For more detailed information about the transfer rate, bus length or cable requirements for the respective interfaces/buses, see "[Cable data](#)" on page 245.

### **Terminating resistor**

A terminating resistor for the CAN interface is already integrated in the IF option. This can be switched on or off with a switch (1); it is necessary to open the system unit for this. A switched-on terminating resistor is indicated by a yellow LED (2) (see "[Reading LED status indicators](#)" on page 244).

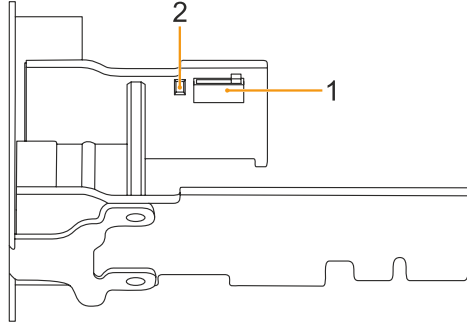

#### 4.2.4.14.3.4 X2X Link master interface - Pinout

The X2X Link master interface is available in the IF option 2 add-on slot.

X2X Link master <sup>1)2)</sup>	
Variant	10-pin, male
Galvanic isolation	Yes
Pin	Pinout
1	X2X
2	Shield
3	X2X\
4	X2X⊥
5	-
6	-
7	-
8	-
9	-
10	-

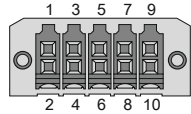

- 1) The interfaces, etc. available on the device or module have been numbered for the purpose of clear differentiation. This numbering may deviate from the numbering used by the respective operating system, however.
- 2) This interface can only be used in Automation Runtime and is displayed as IF2 in Automation Studio / Automation Runtime. It is not a "PC interface" and therefore not displayed in BIOS.

#### 4.2.4.14.4 Shielding

For the interfaces on the 10-pin female connector, the shield of the interfaces can be connected to pin *Shield* (pin 2) of the female connector.

In addition, there is a functional ground connection on the interface cover of the system unit that can also be used for the cable shields.

#### 4.2.4.14.5 Driver support and firmware update

The driver is part of the Automation Runtime and the firmware is part of Automation Studio. The module is automatically brought up to this level.

To update the firmware contained in Automation Studio, a hardware upgrade must be performed (see **Project management / Workspace / Upgrades** in Automation Help).

### 4.2.4.15 5ACCIF02.ISS0-000

#### 4.2.4.15.1 General information

Interface option 5ACCIF02.ISS0-000 is equipped with two RS232/RS422/RS485 interfaces. The operating mode (RS232/RS422/RS485) is selected automatically depending on the electrical connection.

- 2x RS232/RS422/RS485 interfaces
- Compatible with APC3100/PPC3100

This interface option can only be operated in slot IF option 2 and additionally uses slot IF option 2 add-on.

Simultaneous operation of this interface option with interface option 5AC901.I232-00 or 5AC901.I485-00 in slot IF option 1 is not possible.

#### 4.2.4.15.2 Order data

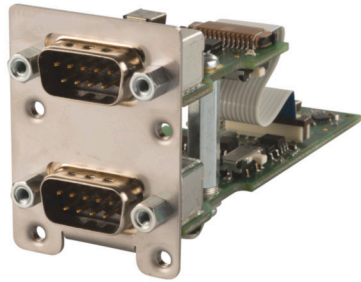
Order number	Short description	Figure
5ACCIF02.ISS0-000	Interface card - 2x RS232/RS422/RS485 interface - For APC3100/PPC3100	

#### 4.2.4.15.3 Technical data

### Information:

The following specified characteristic data, features and limit values are only valid for this accessory and may differ from those of the complete system. The data specified for the complete system applies to the complete system in which this accessory is installed, for example.

Order number	5ACCIF02.ISS0-000
<b>General information</b>	
B&R ID code	0xF725
Certifications	
CE	Yes
UL	cULus E115267 Industrial control equipment
<b>Interfaces</b>	
COM	
Quantity	2
Type	RS232/RS422/RS485, galvanically isolated
Variant	DSUB, 9-pin, male
UART	16550-compatible, 16-byte FIFO buffer
Max. baud rate	115 kbit/s
Terminating resistor	
Type	Possible to switch each on/off via slide switch
Default setting	Each off
<b>Electrical properties</b>	
Power consumption	1.5 W
<b>Operating conditions</b>	
Pollution degree per EN 61131-2	Pollution degree 2
<b>Ambient conditions</b>	
Temperature	
Operation	0 to 60°C <sup>1)</sup>
Storage	-20 to 60°C
Transport	-20 to 60°C

Table 44: 5ACCIF02.ISS0-000 - Technical data

## Technical data

<b>Order number</b>	<b>5ACCIF02.ISS0-000</b>
Relative humidity	
Operation	5 to 90%, non-condensing
Storage	5 to 95%, non-condensing
Transport	5 to 95%, non-condensing
<b>Mechanical properties</b>	
Weight	Approx. 100 g

Table 44: 5ACCIF02.ISS0-000 - Technical data

1) For detailed information, see the temperature tables in the user's manual.

### 4.2.4.15.3.1 Pinout

Serial interfaces COM C and COM D			
	RS232	RS422/485	
Variant	DSUB, 9-pin, male		
Type	RS232, not modem supported		
UART	16550-compatible, 16-byte FIFO buffer		
Galvanic isolation	Yes		
Transfer rate	Max. 115 kbit/s		
Bus length	Max. 15 m	Max. 1200 m	
	<b>RS232 - Pinout</b>	<b>RS422 - Pinout</b>	
<b>Pin</b>			
1	NC		TXD\
2	RXD		NC
3	TXD		NC
4	NC		TXD
5	GND		GND
6	NC		RXD\
7	RTS		NC
8	CTS		NC
9	NC		RXD

### 4.2.4.15.3.2 I/O address and IRQ

Slot (interface)	I/O address <sup>1)</sup>	IRQ <sup>1)</sup>
IF option 2 add-on (COM C)	2E8h - 2EFh	5
IF option 2 (COM D)	338h - 33Fh	7

1) The default I/O address and IRQ can be modified in BIOS.

### 4.2.4.15.3.3 Cable data

For more detailed information about the transfer rate, bus length or cable requirements for the respective interfaces/buses, see "[Cable data](#)" on page 245.

### 4.2.4.15.3.4 Operation as RS485 interface

The pins of the RS422 default interface (1, 4, 6 and 9) must be used for operation. To do this, connect the pins as shown.

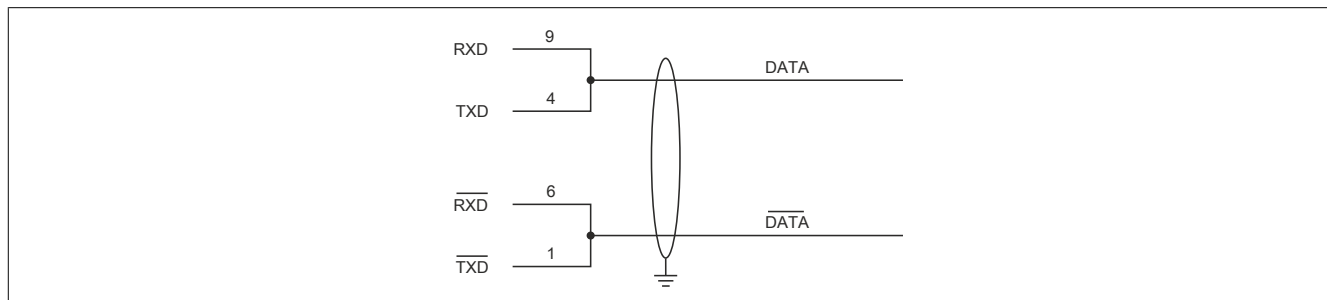

Figure 2: RS232/RS422/RS485 interface - Operation in RS485 mode

The RTS line must be switched by the driver for each transmission or reception; switching back does not take place automatically. This cannot be configured in Windows.

With long cable lengths, the voltage drop can result in greater potential differences between the bus devices, which can hinder communication. This can be improved by running the ground wire with the others.

The cable ends of an RS485 bus should be terminated (at least for longer cable lengths or higher transfer rates). Passive termination can normally be used by connecting the signal lines via a 120 Ω resistor at each of the two bus ends; see "[Terminating resistor](#)" for the IF card.

#### 4.2.4.15.3.5 Terminating resistor

A terminating resistor is already integrated on the IF option for each COM. This can be switched on or off with a switch; it is necessary to open the system unit for this.

The terminating resistors are switched off on delivery. The state of the respective terminating resistor is indicated by an LED (see "Reading LED status indicators" on page 244).

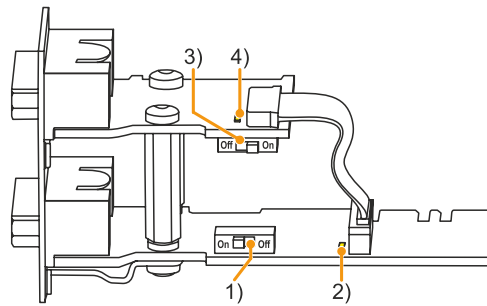

Assignment	State	Explanation
1) COM C terminating resistor	On	Enabled
	Off	Disabled
2) LED status indicator for COM C terminating resistor Color: Yellow	On	COM C terminating resistor on
	Off	COM C terminating resistor off
3) COM D terminating resistor	On	Enabled
	Off	Disabled
4) LED status indicator for COM D terminating resistor Color: Yellow	On	COM D terminating resistor on
	Off	COM D terminating resistor off

#### 4.2.4.15.3.6 Firmware

In order to ensure the functionality of the interface option, at least the following firmware version (MTCX) must be installed on the PC:

- Automation PC 3100: V4.21
- Panel PC 3100: V4.21

The firmware can be downloaded from the B&R website ([www.br-automation.com](http://www.br-automation.com)).

For information about upgrading the firmware, see section "PC firmware upgrade" on page 180.

#### 4.2.4.15.4 Driver support

Drivers for approved operating systems are available for download in the Downloads section of the B&R website ([www.br-automation.com](http://www.br-automation.com)) (if required and not already included in the operating system).

Approved operating systems:

- Automation Runtime
- B&R Linux
- Windows 10

#### 4.2.4.16 5ACCIF04.FPLK-000

##### 4.2.4.16.1 General information

Interface option 5ACCIF04.FPLK-000 is equipped with a POWERLINK interface.

- 1x POWERLINK interface (managing or controlled node) for real-time communication
- Poll-response chaining
- Compatible with APC3100/PPC3100
- Easy installation in slot *IF option 3*.
- Support in Automation Runtime and Automation Studio: Both starting with V4.9

Simultaneous operation with another POWERLINK interface card (see [IF option 2 slot](#)) in slot *IF option 2* with different addressing is possible. This allows parallel data acquisition from two separate networks.

With poll-response chaining (PRC), the IF option offers a solution for the highest demands on response time and the shortest cycle times. When combined with the B&R control system, poll-response chaining provides ideal performance, particularly for central control tasks.

This interface option can only be operated in the IF option 3 slot and is only supported by Automation Runtime.

##### 4.2.4.16.2 Order data

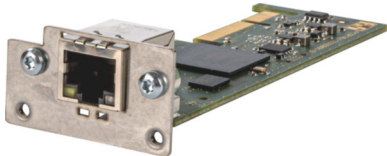
Order number	Short description	Figure
5ACCIF04.FPLK-000	Interface card - 1x POWERLINK interface - For APC3100/PPC3100	

##### 4.2.4.16.3 Technical data

### Information:

The following specified characteristic data, features and limit values are only valid for these individual components and may differ from those of the complete system. The data specified for the complete system applies to the complete system in which this individual component is used, for example.

Order number	5ACCIF04.FPLK-000
<b>General information</b>	
B&R ID code	0xFC5E
Diagnostics	
Data transfer	Yes, using LED status indicator
Certifications	
CE	Yes
UL	cULus E115267 Industrial control equipment
<b>Interfaces</b>	
POWERLINK	
Quantity	1
Type	Type 4 <sup>1)</sup>
Variant	RJ45, shielded
Transfer rate	100 Mbit/s
Transfer	100BASE-TX
Line length	Max. 100 m between two stations (segment length)
<b>Electrical properties</b>	
Power consumption	1.5 watts
<b>Operating conditions</b>	
Pollution degree per EN 61131-2	Pollution degree 2
<b>Ambient conditions</b>	
Temperature	
Operation	0 to 55°C
Storage	-20 to 60°C
Transport	-20 to 60°C



<b>Order number</b>	<b>5ACCIF04.FPLK-000</b>
Relative humidity	
Operation	5 to 90%, non-condensing
Storage	5 to 95%, non-condensing
Transport	5 to 95%, non-condensing
<b>Mechanical properties</b>	
Weight	Approx. 25 g

1) For additional information, see Automation Help (Communication - POWERLINK - General - Hardware - IF / LS).

#### 4.2.4.16.3.1 Pinout

The POWERLINK interface is available in the IF option 3 slot.

POWERLINK interface		
Variant	RJ45, female	
Wiring	S/STP (Cat 5e)	
Cable length	Max. 100 m (min. Cat 5e)	
<b>LED "Link" (a)</b>	<b>On</b>	<b>Active</b>
Orange (light)	Link (a connection to a POWERLINK network exists)	Blinking (data being transferred)
<b>LED "Status" (b)</b>	<b>On</b>	<b>Off</b>
Green/Red	POWERLINK status see "LED "S/E" (status/error LED)" on page 247	

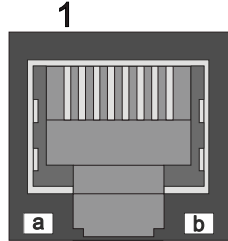

The diagram shows a top-down view of the RJ45 port. The port is labeled with the number '1' at the top. Below the port, there are two LEDs labeled 'a' and 'b'. LED 'a' is on the left and LED 'b' is on the right.

#### POWERLINK commissioning and operation

For a description of the operating modes, status and node numbers of the POWERLINK interface(s), see "LED "S/E" (status/error LED)" on page 247.

#### 4.2.4.16.4 Driver support and firmware update

To ensure the functionality of the interface option, the following minimum versions must be used:

- APC3100 MTCX: V4.22
- APC3100 BIOS: V1.20
- Automation Studio: V4.9

The driver is part of the Automation Runtime and the firmware is part of Automation Studio. The module is automatically brought up to this level.

To update the firmware contained in Automation Studio, a hardware upgrade must be performed (see **Project management / Workspace / Upgrades** in Automation Help).

## 4.2.5 Mass storage options

### Information:

Mass storage options can only be operated on the "IF option 3 slot" on page 50.

### Information:

For information about replacing or installing an interface option, see section "Installing the interface option and DDR4 SDRAM" on page 220.

Depending on the IF option used, it may be necessary to load the default settings in BIOS after replacement or installation (see "Exit" on page 178).

### 4.2.5.1 5ACCMS01.MDT2-000

#### 4.2.5.1.1 General

5ACCMS01.MDT2-000 is an adapter card for M.2 mass storage devices. B&R offers two corresponding configurable M.2 solid-state drives (5ACCMSM2.xxxx-000).

- Compatible with APC3100/PPC3100
- Easy installation in slot *IF option 3*.
- 5ACCMSM2.xxxx-000 memory sizes: 512 GB or 1 TB

### Notice!

**B&R cannot guarantee the function of third-party M.2 mass storage devices. The functionality of mass storage devices available from B&R is ensured.**

#### 4.2.5.1.2 Order data

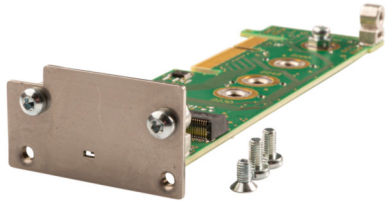
Order number	Short description	Figure
	<b>Mass storage options</b>	
5ACCMS01.MDT2-000	Adapter card for M.2 mass storage device - For APC3100/PPC3100	
	<b>Optional accessories</b>	
	<b>Mass storage options</b>	
5ACCMSM2.0512-000	512 GB M.2 SSD MLC - Innodisk - SATA	
5ACCMSM2.1024-000	1 TB M.2 SSD MLC - Innodisk - SATA	

4.2.5.1.3 Technical data

**Information:**

The following specified characteristic data, features and limit values are only valid for these individual components and may differ from those of the complete system. The data specified for the complete system applies to the complete system in which this individual component is used, for example.

<b>Order number</b>	<b>5ACCMS01.MDT2-000</b>
<b>General information</b>	
LEDs	Yes, 1x activity indicator
B&R ID code	0xFCCC
Certifications	
CE	Yes
UL	cULus E115267 Industrial control equipment
<b>Interfaces</b>	
Add-on interface slot	
Quantity	1x M.2 SSD
<b>Electrical properties</b>	
Power consumption	Depends on the mass storage device used
<b>Operating conditions</b>	
Pollution degree per EN 61131-2	Pollution degree 2
<b>Ambient conditions <sup>1)</sup></b>	
Temperature	
Operation	0 to 55°C
Storage	-20 to 60°C
Transport	-20 to 60°C
Relative humidity	
Operation	5 to 90%, non-condensing
Storage	5 to 95%, non-condensing
Transport	5 to 95%, non-condensing
<b>Mechanical properties</b>	
Weight	Approx. 35 g <sup>2)</sup>

1) These values can be limited by the mass storage device used.

2) Without mass storage device.

**4.2.5.1.3.1 Status LED**

Adapter card 5ACCMS01.MDT2-000 has a yellow LED status indicator on the front panel that serves as an activity indicator.

- On: Mass storage device being accessed (write or read procedure)
- Off: Mass storage device not being accessed

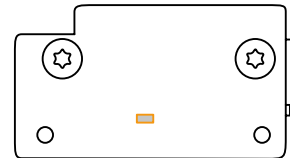

### 4.2.5.2 5ACCMSM2.xxxx-000

#### 4.2.5.2.1 General information

5ACCMSM2.xxxx-000 are M.2 mass storage devices (SSD) and can be used with adapter card 5ACCMS01.MDT2-000 as an interface option in APC3100/PPC3100 system units.

- Compatible with APC3100/PPC3100 (using adapter card 5ACCMS01.MDT2-000)
- Solid-state drives
- MLC technology
- SATA support
- 512 GB or 1 TB

### Caution!

**M.2 mass storage devices are not designed for hot-plugging or hot-swapping per the Next Generation Form Factor (NGFF) specification. It is therefore not permitted to connect or replace M.2 mass storage devices during operation.**

#### 4.2.5.2.2 Order data

Order number	Short description	Figure
<b>Mass storage options</b>		
5ACCMSM2.0512-000	512 GB M.2 SSD MLC - Innodisk - SATA	
5ACCMSM2.1024-000	1 TB M.2 SSD MLC - Innodisk - SATA	
<b>Optional accessories</b>		
<b>Mass storage options</b>		
5ACCMS01.MDT2-000	Adapter card for M.2 mass storage device - For APC3100/PPC3100	

#### 4.2.5.2.3 Technical data

### Information:

The following specified characteristic data, features and limit values are only valid for these individual components and may differ from those of the complete system. The data specified for the complete system applies to the complete system in which this individual component is used, for example.

Order number	5ACCMSM2.0512-000	5ACCMSM2.1024-000
<b>General information</b>		
Data retention <sup>1)</sup>	10 years <sup>2)</sup>	
B&R ID code	0xFCCD	0xFCCE
Certifications		
CE	Yes	
UL	cULus E115267 Industrial control equipment	
<b>Solid-state drive</b>		
Capacity	512 GB	1024 GB
Data reliability	<1 unrecoverable error per 10 <sup>15</sup> bits read	
MTBF	3,000,000 h	
S.M.A.R.T. support	Yes	
Interface	SATA	
Continuous reading	Max. 560 MB/s	
Continuous writing	Max. 450 MB/s	
IOPS <sup>3)</sup>		
4k read	Max. 76,000 (random)	
4k write	Max. 76,000 (random)	
<b>Endurance</b>		
MLC flash memory	Yes	
Guaranteed data volume		
Client workload	600 TBW <sup>4)</sup>	1172 TBW <sup>4)</sup>
Compatibility	SATA 3.1 compliant ACS-2 SSD Enhanced SMART ATA feature set Native Command Queuing (NCQ)	
Storage health data support <sup>5)</sup>	Yes, AR 4.90 and later	
<b>Electrical properties</b>		
Power consumption	Max. 3.5 W	

Order number	5ACCMSM2.0512-000	5ACCMSM2.1024-000
<b>Ambient conditions <sup>6)</sup></b>		
Temperature		
Operation		-40 to 85°C
Storage		-55 to 95°C
Transport		-55 to 95°C
Relative humidity		
Operation		10 to 90%, non-condensing
Storage		10 to 95%, non-condensing
Transport		10 to 95%, non-condensing
Vibration		
Operation		7 to 2000 Hz: 20 g
Storage		7 to 2000 Hz: 20 g
Transport		7 to 2000 Hz: 20 g
Shock		
Operation		1500 g, 0.5 ms
Storage		1500 g, 0.5 ms
Transport		1500 g, 0.5 ms
<b>Mechanical properties</b>		
Dimensions		
Width		22 mm
Height		80 mm
Weight		Approx. 15 g
<b>Vendor information</b>		
Manufacturer		Innodisk
Manufacturer's product ID	M.2 (S80) 3MV2-P 512 GB	M.2 (S80) 3MV2-P 1 TB

- 1) Per JEDEC (JESD47), EOL conditions are not permitted to be reached before 18 months. A higher average daily write workload reduces the expected service life and data retention of the data storage medium.
- 2) At 25°C ambient temperature at the start of service life.
- 3) IOPS: Random read and write input/output operations per second
- 4) TBW: Terabytes written  
Client workload per standard JEDEC JESD219
- 5) For details about *Storage Health Data*, see Automation Help.
- 6) These values can be limited by the adapter card used.

#### 4.2.5.2.4 Installing M.2 mass storage devices

The installation of M.2 mass storage devices in adapter card 5ACCMS01.MDT2-000 is described in section "[Installing M.2 mass storage devices](#)" on page 224.

## 4.2.6 Uninterruptible power supply (UPS)

With the optionally integrated UPS, the B&R industrial PC ensures that the PC system can complete write operations even after a power failure occurs. If the UPS detects a power failure, it switches to battery operation immediately without interruption. All running programs are properly exited by the UPS software. The possibility of inconsistent data is eliminated (only works if the UPS has already been configured and the driver is enabled).

### Information:

- **An external panel or monitor is not buffered by the UPS and will fail if a power failure occurs.**

Because the charging circuit is integrated in the housing of the B&R industrial PC, installation has been reduced to simply attaching the connection cable to the battery unit installed next to the PC.

Special emphasis was placed on simplified maintenance when designing the battery unit. Batteries are easily accessible from the front and can be replaced in just a few moments when servicing.

### 4.2.6.1 Requirements

- A suitable system unit
- UPS IF option 5AC901.IUPS-00 or 5AC901.IUPS-01
- Battery unit 5AC901.BUPS-00 or 5AC901.BUPS-01
- UPS connection cable 5CAUPS.00xx-01
- B&R UPS configured in the ADI Control Center

### Warning!

**Battery unit 5AC901.BUPS-00 is only permitted to be operated with UPS IF option 5AC901.IUPS-00!**

**Battery unit 5AC901.BUPS-01 is only permitted to be operated with UPS IF option 5AC901.IUPS-01!**

### Information:

For information about installation and connecting to the UPS IF option, see section ["Installing and connecting the UPS battery unit"](#) on page 225.

### 4.2.6.2 5AC901.IUPS-00

#### 4.2.6.2.1 General information

UPS IF option 5AC901.IUPS-00 used together with battery unit 5AC901.BUPS-00 allows the B&R industrial PC to be switched off properly without data loss during a power failure.

This interface option can only be operated in slot IF option 1.

#### Warning!

UPS IF option 5AC901.IUPS-00 is only permitted to be operated with battery unit 5AC901.BUPS-00!

#### Information:

If the system is in power saving mode (S5: soft-off or S4: hibernate/suspend-to-disk), then the internal UPS interface option charges the connected battery unit. The system's internal power supplies are active during this procedure. This allows various actions to be performed (e.g. opening the tray of the built-in slide-in DVD drive).

#### 4.2.6.2.2 Order data

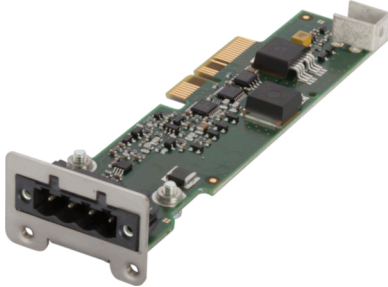
Order number	Short description	Figure
	<b>Uninterruptible power supply</b>	
5AC901.IUPS-00	UPS - For 4.5 Ah battery	
	<b>Required accessories</b>	
	<b>Uninterruptible power supply</b>	
5AC901.BUPS-00	Battery unit 4.5 Ah - For UPS 5AC901.IUPS-00	
5CAUPS.0005-01	UPS cable - 0.5 m - For 5AC901.IUPS-xx	
5CAUPS.0010-01	UPS cable - 1 m - For 5AC901.IUPS-xx	
5CAUPS.0013-01	UPS cable - 1.3 m - For 5AC901.IUPS-xx	
5CAUPS.0030-01	UPS cable - 3 m - For 5AC901.IUPS-xx	

#### 4.2.6.2.3 Technical data

#### Information:

The following specified characteristic data, features and limit values are only valid for this accessory and may differ from those of the complete system. The data specified for the complete system applies to the complete system in which this accessory is installed, for example.

Order number	5AC901.IUPS-00
<b>General information</b>	
B&R ID code	0xD851
Certifications	
CE	Yes
UL	cULus E115267 Industrial control equipment
HazLoc	cULus HazLoc E180196 Industrial control equipment for hazardous locations
EAC	Class I, Division 2, Groups ABCD, T4 <sup>1)</sup> Product family certification
<b>Electrical properties</b>	
Power consumption	Max. 30 W at 1 A
Deep discharge protection	Yes
Short-circuit proof	Yes <sup>2)</sup>
Battery charging data	
Charging current	Typ. 1 A
<b>Operating conditions</b>	
Pollution degree per EN 61131-2	Pollution degree 2
<b>Ambient conditions</b>	
Temperature	
Operation	0 to 55°C <sup>3)</sup>
Storage	-20 to 60°C
Transport	-20 to 60°C

## Technical data

<b>Order number</b>	<b>5AC901.IUPS-00</b>
Relative humidity	
Operation	5 to 90%, non-condensing
Storage	5 to 95%, non-condensing
Transport	5 to 95%, non-condensing
<b>Mechanical properties</b>	
Weight	Approx. 28 g

- 1) Yes, but applies only if all components installed in the complete system have this certification and the complete system bears the corresponding mark.
- 2) The interface option is short-circuit proof. This value does not apply to the connected battery unit.
- 3) For detailed information, see the temperature tables in the user's manual.

### 4.2.6.2.3.1 Pinout

UPS interface	
Variant	4-pin, male
Pin	Pinout
1	Temperature sensor
2	Temperature sensor
3	-
4	+

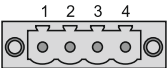

### 4.2.6.2.4 Installation

This module is installed using the materials included in delivery. For additional information regarding installation, see section "[Installing the interface option and DDR4 SDRAM](#)" on page 220.



### 4.2.6.3 5AC901.IUPS-01

#### 4.2.6.3.1 General information

UPS IF option 5AC901.IUPS-01 used together with battery unit 5AC901.BUPS-01 allows the B&R industrial PC to be switched off properly without data loss during a power failure.

This interface option can only be operated in slot IF option 1.

#### Warning!

UPS IF option 5AC901.IUPS-01 is only permitted to be operated with battery unit 5AC901.BUPS-01!

#### Information:

If the system is in power saving mode (S5: soft-off or S4: hibernate/suspend-to-disk), then the internal UPS interface option charges the connected battery unit. The system's internal power supplies are active during this procedure. This allows various actions to be performed (e.g. opening the tray of the built-in slide-in DVD drive).

#### 4.2.6.3.2 Order data

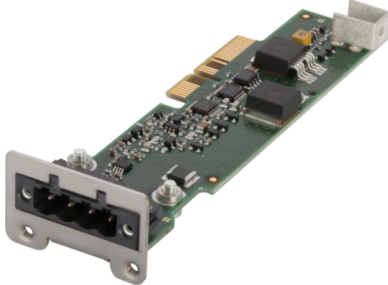
Order number	Short description	Figure
	<b>Uninterruptible power supply</b>	
5AC901.IUPS-01	UPS - For 2.2 Ah battery	
	<b>Required accessories</b>	
	<b>Uninterruptible power supply</b>	
5AC901.BUPS-01	Battery unit 2.2 Ah - For UPS 5AC901.IUPS-01	
5CAUPS.0005-01	UPS cable - 0.5 m - For 5AC901.IUPS-xx	
5CAUPS.0010-01	UPS cable - 1 m - For 5AC901.IUPS-xx	
5CAUPS.0013-01	UPS cable - 1.3 m - For 5AC901.IUPS-xx	
5CAUPS.0030-01	UPS cable - 3 m - For 5AC901.IUPS-xx	

#### 4.2.6.3.3 Technical data

#### Information:

The following specified characteristic data, features and limit values are only valid for this accessory and may differ from those of the complete system. The data specified for the complete system applies to the complete system in which this accessory is installed, for example.

Order number	5AC901.IUPS-01
<b>General information</b>	
B&R ID code	0xDF84
Certifications	
CE	Yes
UL	cULus E115267 Industrial control equipment
HazLoc	cULus HazLoc E180196 Industrial control equipment for hazardous locations
EAC	Class I, Division 2, Groups ABCD, T4 <sup>1)</sup> Product family certification
<b>Electrical properties</b>	
Power consumption	Max. 25 W at 0.9 A
Deep discharge protection	Yes
Short-circuit proof	Yes <sup>2)</sup>
Battery charging data	
Charging current	Typ. 0.88 A
<b>Operating conditions</b>	
Pollution degree per EN 61131-2	Pollution degree 2
<b>Ambient conditions</b>	
Temperature	
Operation	0 to 55°C <sup>3)</sup>
Storage	-20 to 60°C
Transport	-20 to 60°C

## Technical data

<b>Order number</b>	<b>5AC901.IUPS-01</b>
Relative humidity	
Operation	5 to 90%, non-condensing
Storage	5 to 95%, non-condensing
Transport	5 to 95%, non-condensing
<b>Mechanical properties</b>	
Weight	Approx. 28 g

- 1) Yes, but applies only if all components installed in the complete system have this certification and the complete system bears the corresponding mark.
- 2) The interface option is short-circuit proof. This value does not apply to the connected battery unit.
- 3) For detailed information, see the temperature tables in the user's manual.

### 4.2.6.3.3.1 Pinout

UPS interface	
Variant	4-pin, male
Pin	Pinout
1	Temperature sensor
2	Temperature sensor
3	-
4	+

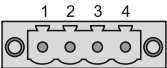

### 4.2.6.3.4 Installation

This module is installed using the materials included in delivery. For additional information regarding installation, see section "[Installing the interface option and DDR4 SDRAM](#)" on page 220.

#### 4.2.6.4 5AC901.BUPS-00

##### 4.2.6.4.1 General information

- Battery unit for UPS IF option 5AC901.IUPS-00
- Single-cell rechargeable battery
- 2 Hawker Cyclon 12 V, 4.5 Ah rechargeable batteries connected in series
- Rated voltage 24 V
- Capacity 4.5 Ah

The battery unit is subject to wear and should be replaced regularly (after the specified service life at the latest).

### Warning!

**Battery unit 5AC901.BUPS-00 is only permitted to be operated with UPS IF option 5AC901.IUPS-00!**

### Information:

If the max. specified temperature limits of the battery unit are overshoot or undershot, the temperature alarm of the battery unit is set. Battery backing is no longer provided if the temperature alarm for the battery unit is active. The battery is also no longer charged since this can result in damage to the battery. This temperature alarm is defined with a hysteresis of 5°C, i.e. the temperature alarm is only cleared again if the minimum temperature limit is again overshoot by this hysteresis or the maximum temperature limit is again undershot by this hysteresis. The temperature or temperature alarm of the battery unit is not only monitored and checked at runtime, but also when the system is powered on; it can be evaluated using the B&R ADI library.

##### 4.2.6.4.2 Order data

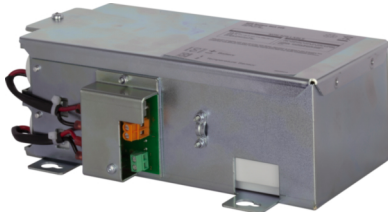
Order number	Short description	Figure
	<b>Uninterruptible power supply</b>	
5AC901.BUPS-00	Battery unit 4.5 Ah - For UPS 5AC901.IUPS-00	
	<b>Required accessories</b>	
	<b>Uninterruptible power supply</b>	
5CAUPS.0005-01	UPS cable - 0.5 m - For 5AC901.IUPS-xx	
5CAUPS.0010-01	UPS cable - 1 m - For 5AC901.IUPS-xx	
5CAUPS.0013-01	UPS cable - 1.3 m - For 5AC901.IUPS-xx	
5CAUPS.0030-01	UPS cable - 3 m - For 5AC901.IUPS-xx	

##### 4.2.6.4.3 Technical data

### Information:

The following specified characteristic data, features and limit values are only valid for this accessory and may differ from those of the complete system. The data specified for the complete system applies to the complete system in which this accessory is installed, for example.

Order number	5AC901.BUPS-00
<b>General information</b>	
B&R ID code	0xD82E
Battery	
Type	Hawker Cyclon 12 V, 4.5 Ah, two rechargeable batteries connected in series
Service life	Up to 15 years at 20°C / 10 years at 25°C <sup>1)</sup>
Variant	Single cell
Temperature sensor	NTC resistance
Service interval during storage	Charge 1 time every 6 months
Charge duration when battery low	Typ. 7 hours
Certifications	
CE	Yes
UL	cULus E115267 Industrial control equipment
HazLoc	cULus HazLoc E180196 Industrial control equipment for hazardous locations Class I, Division 2, Groups ABCD, T4 <sup>2)</sup>
EAC	Product family certification
<b>Electrical properties</b>	
Nominal voltage	24 V
Capacity	4.5 Ah

## Technical data

<b>Order number</b>	<b>5AC901.BUPS-00</b>
Fuse	Yes
Battery charging data	
Charging current <sup>3)</sup>	Typ. 1 A
<b>Operating conditions</b>	
Pollution degree per EN 61131-2	Pollution degree 2
<b>Ambient conditions</b>	
Temperature	
Operation	-30 to 60°C <sup>4)</sup>
Storage	-65 to 80°C
Transport	-65 to 80°C
Relative humidity	
Operation	5 to 95%, non-condensing
Storage	5 to 95%, non-condensing
Transport	5 to 95%, non-condensing
Elevation	
Operation	Max. 3000 m
<b>Mechanical properties</b>	
Dimensions	
Width	223.2 mm
Height	78.2 mm
Depth	145 mm
Weight	Approx. 4600 g

- 1) Depends on the charging and discharging cycles (up to 80% battery capacity).
- 2) Yes, but applies only if all components installed in the complete system have this certification and the complete system bears the corresponding mark.
- 3) Maximum charging current.
- 4) Battery backing is no longer provided if the temperature undershoots the minimum temperature or overshoots the maximum temperature. The battery is also no longer charged since this can result in damage to the battery.

### 4.2.6.4.4 Service life

The following diagram shows the relationship between ambient temperature and service life.

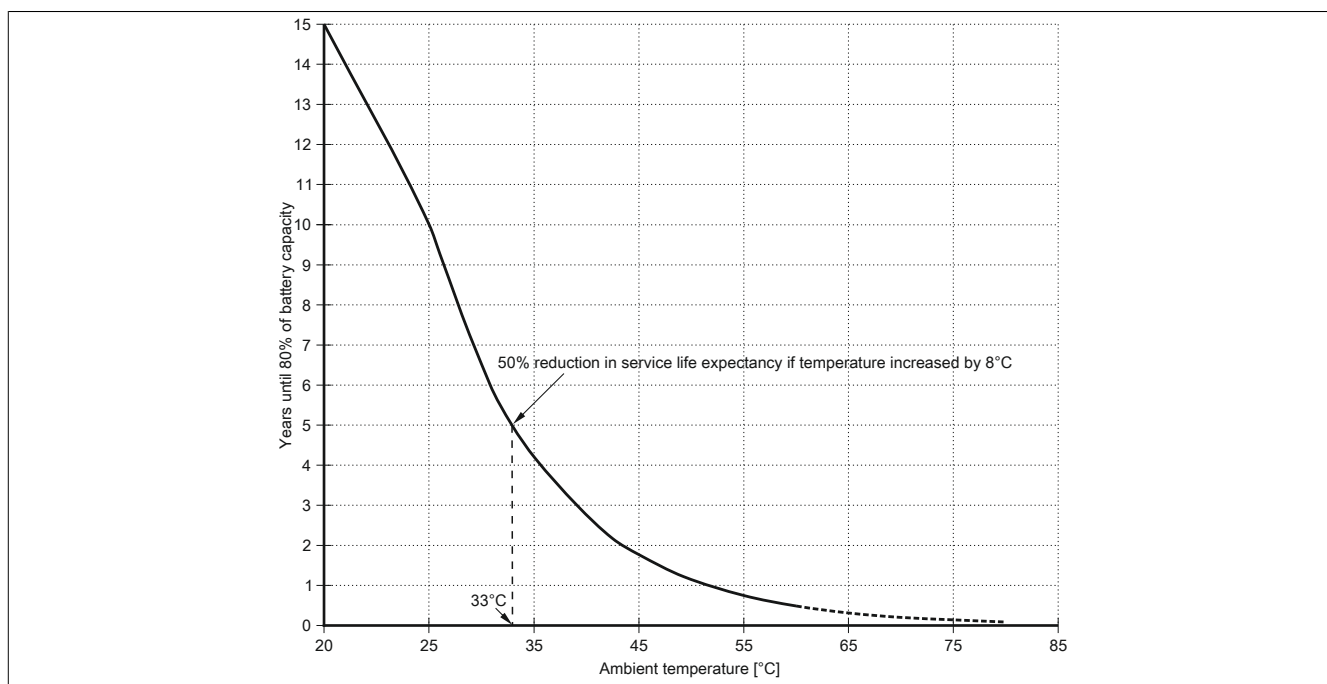

#### 4.2.6.4.5 5AC901.BUPS-00 - Dimensions

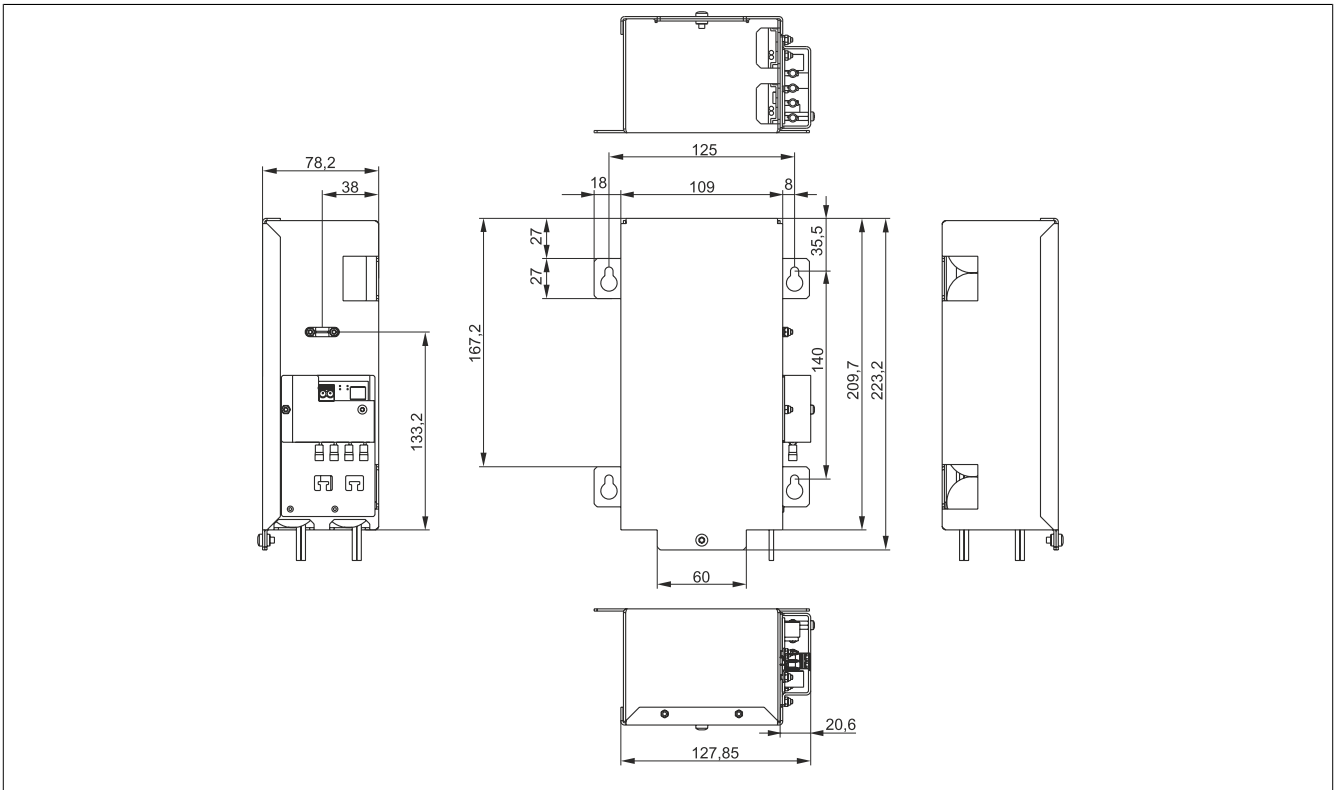

#### 4.2.6.4.6 5AC901.BUPS-00 - Drilling template

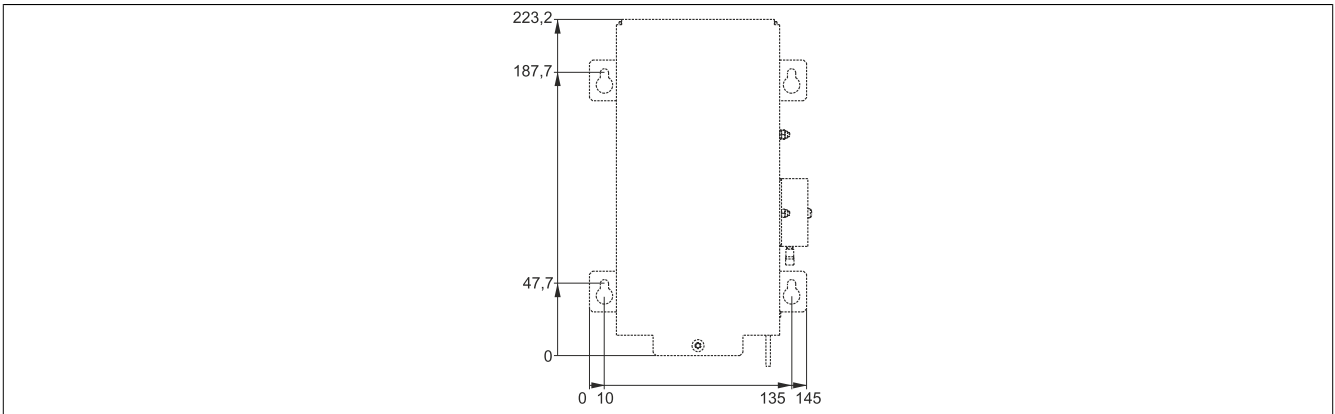

#### 4.2.6.4.7 Installation

For information about installation and connecting to the UPS IF option, see section "[Installing and connecting the UPS battery unit](#)" on page 225.

#### 4.2.6.4.8 Precautions for handling and use

##### Spills and leaks:

Further leakage must be prevented. Smaller spills must be bonded with dry sand, dirt and vermiculite. The use of flammable materials is not permitted. If possible, neutralize acids with sodium bicarbonate, chalk, etc. Acid-resistant clothing, shoes, gloves as well as acid-resistant face protection must be worn. The disposal of unneutralized acid in the sewage system is prohibited!

##### Waste disposal:

Used batteries and rechargeable batteries must be disposed of in an environmentally friendly recycling process. Neutralized mud must be stored in closed containers and stored / disposed of in accordance with applicable regulations. After neutralization and inspection, larger spills diluted with water must be disposed of in accordance with applicable regulations.

**Handling and storage:**

- Store in cool, dry and well-ventilated rooms with impermeable surfaces and appropriate containment conditions in case of leakage.
- Protect from adverse weather conditions and separate from incompatible materials during storage and transport.
- A sufficient supply of water must be located nearby.
- Prevent damage to containers in which batteries and rechargeable batteries are stored and transported.
- Keep away from fire, sparks and heat.

### 4.2.6.5 5AC901.BUPS-01

#### 4.2.6.5.1 General information

- Battery unit for UPS IF option 5AC901.IUPS-01
- Maintenance-free lead acid rechargeable battery
- 2x 12 V, 2.2 Ah rechargeable batteries connected in series
- Rated voltage 24 V
- Capacity 2.2 Ah

The battery unit is subject to wear and should be replaced regularly (after the specified service life at the latest).

#### Warning!

**Battery unit 5AC901.BUPS-01 is only permitted to be operated with UPS IF option 5AC901.IUPS-01!**

#### Information:

If the max. specified temperature limits of the battery unit are overshoot or undershot, the temperature alarm of the battery unit is set. Battery backing is no longer provided if the temperature alarm for the battery unit is active. The battery is also no longer charged since this can result in damage to the battery. This temperature alarm is defined with a hysteresis of 5°C, i.e. the temperature alarm is only cleared again if the minimum temperature limit is again overshoot by this hysteresis or the maximum temperature limit is again undershot by this hysteresis. The temperature or temperature alarm of the battery unit is not only monitored and checked at runtime, but also when the system is powered on; it can be evaluated using the B&R ADI library.

#### 4.2.6.5.2 Order data

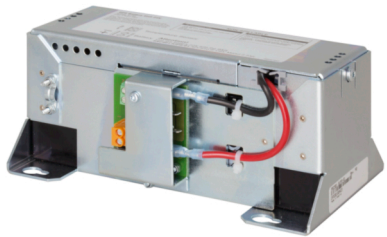
Order number	Short description	Figure
	<b>Uninterruptible power supply</b>	
5AC901.BUPS-01	Battery unit 2.2 Ah - For UPS 5AC901.IUPS-01	
	<b>Required accessories</b>	
	<b>Uninterruptible power supply</b>	
5CAUPS.0005-01	UPS cable - 0.5 m - For 5AC901.IUPS-xx	
5CAUPS.0010-01	UPS cable - 1 m - For 5AC901.IUPS-xx	
5CAUPS.0013-01	UPS cable - 1.3 m - For 5AC901.IUPS-xx	
5CAUPS.0030-01	UPS cable - 3 m - For 5AC901.IUPS-xx	

#### 4.2.6.5.3 Technical data

#### Information:

The following specified characteristic data, features and limit values are only valid for this accessory and may differ from those of the complete system. The data specified for the complete system applies to the complete system in which this accessory is installed, for example.

Order number	5AC901.BUPS-01
<b>General information</b>	
B&R ID code	0xDF83
Battery	
Type	12 V, 2.2 Ah, two rechargeable batteries connected in series
Service life	Up to 5 years at 20°C <sup>1)</sup>
Variant	Maintenance-free lead acid battery
Temperature sensor	NTC resistance
Service interval during storage	Charge 1 time every 6 months
Charge duration when battery low	Typ. 5 hours
Certifications	
CE	Yes
UL	cULus E115267 Industrial control equipment
HazLoc	cULus HazLoc E180196 Industrial control equipment for hazardous locations Class I, Division 2, Groups ABCD, T4 <sup>2)</sup>
EAC	Product family certification
<b>Electrical properties</b>	
Nominal voltage	24 V

## Technical data

<b>Order number</b>	<b>5AC901.BUPS-01</b>
Capacity	2.2 Ah
Fuse	Yes
<b>Battery charging data</b>	
Charging current <sup>3)</sup>	Typ. 0.88 A
<b>Operating conditions</b>	
Pollution degree per EN 61131-2	Pollution degree 2
<b>Ambient conditions</b>	
Temperature	
Operation	0 to 40°C <sup>4)</sup>
Storage	-15 to 40°C
Transport	-15 to 40°C
Relative humidity	
Operation	25 to 85%, non-condensing
Storage	25 to 85%, non-condensing
Transport	25 to 85%, non-condensing
Elevation	
Operation	Max. 3000 m
<b>Mechanical properties</b>	
Dimensions	
Width	188 mm
Height	78 mm
Depth	115 mm
Weight	Approx. 2550 g

- 1) Depends on the charging and discharging cycles.
- 2) Yes, but applies only if all components installed in the complete system have this certification and the complete system bears the corresponding mark.
- 3) Maximum charging current.
- 4) Battery backing is no longer provided if the temperature undershoots the minimum temperature or overshoots the maximum temperature. The battery is also no longer charged since this can result in damage to the battery.

### 4.2.6.5.4 Service life

The following diagram shows the relationship between ambient temperature and service life.

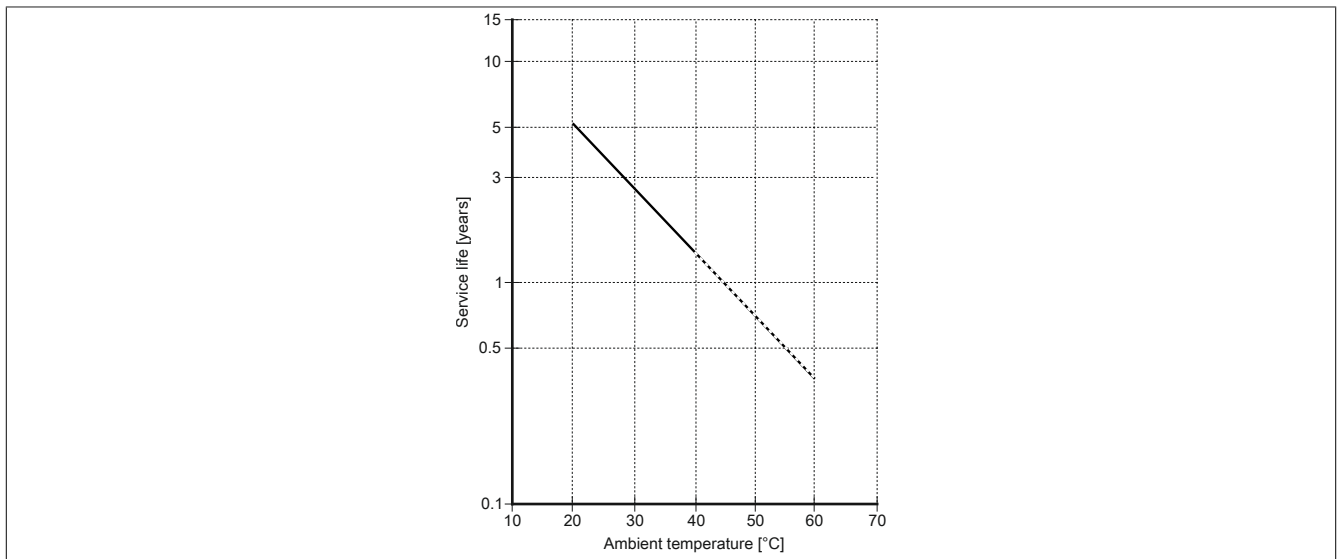



#### 4.2.6.5.5 5AC901.BUPS-01 - Dimensions

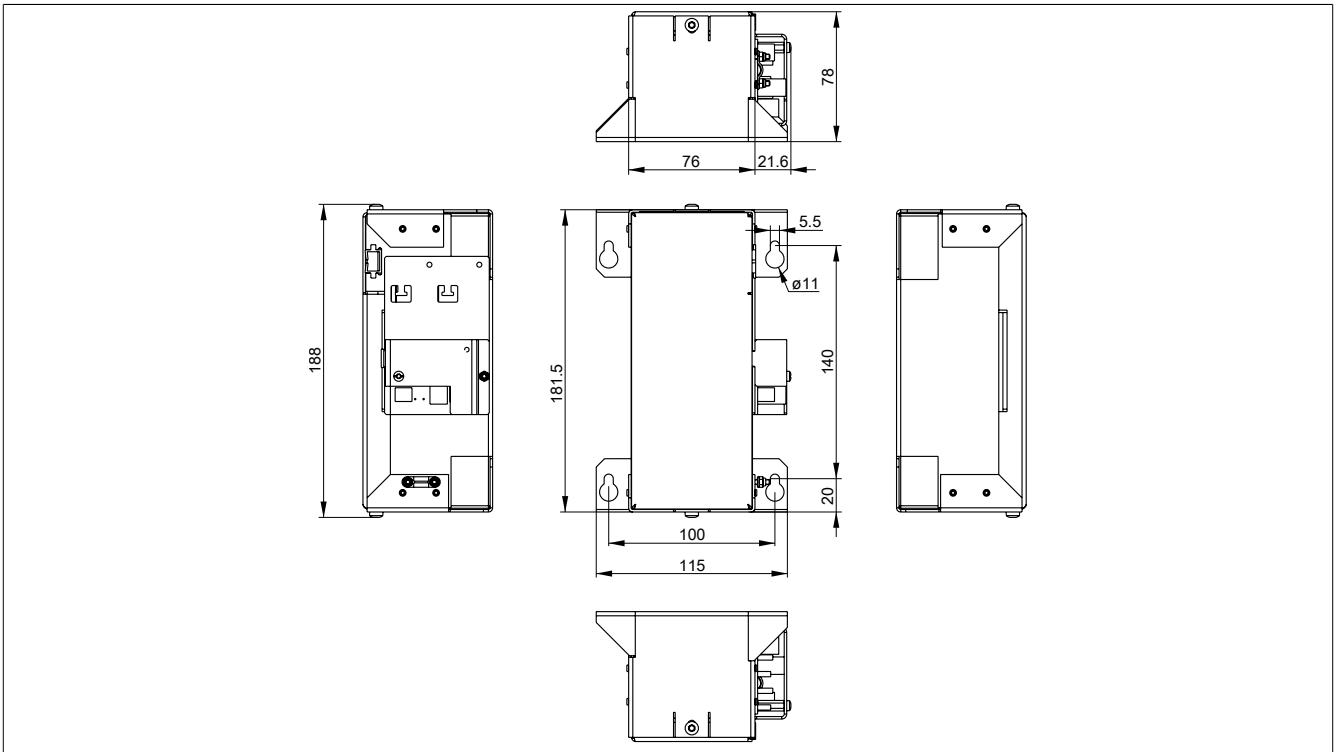

#### 4.2.6.5.6 5AC901.BUPS-01 - Drilling template

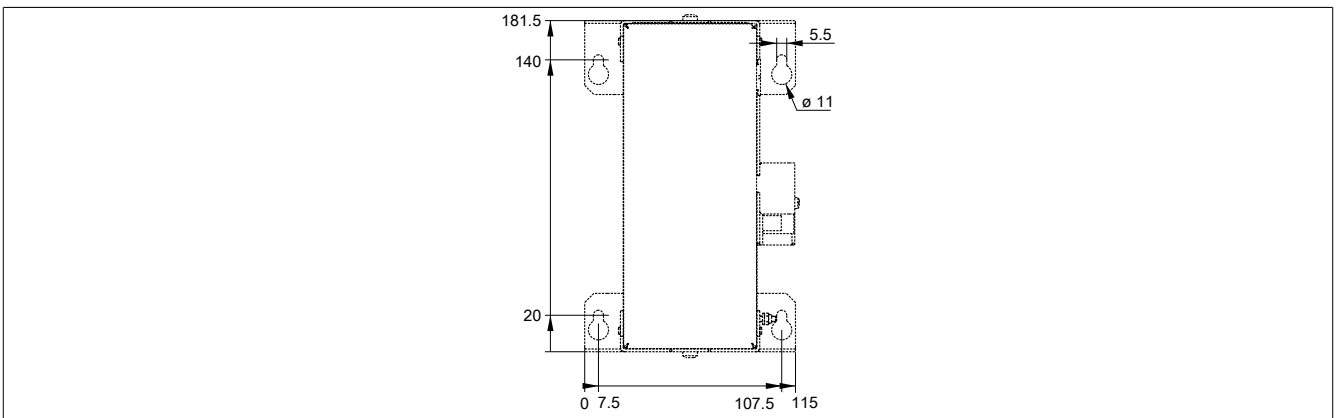

#### 4.2.6.5.7 Installation

For information about installation and connecting to the UPS IF option, see section "[Installing and connecting the UPS battery unit](#)" on page 225.

#### 4.2.6.5.8 Precautions for handling and use

##### Spills and leaks:

Further leakage must be prevented. Smaller spills must be bonded with dry sand, dirt and vermiculite. The use of flammable materials is not permitted. If possible, neutralize acids with sodium bicarbonate, chalk, etc. Acid-resistant clothing, shoes, gloves as well as acid-resistant face protection must be worn. The disposal of unneutralized acid in the sewage system is prohibited!

##### Waste disposal:

Used batteries and rechargeable batteries must be disposed of in an environmentally friendly recycling process. Neutralized mud must be stored in closed containers and stored / disposed of in accordance with applicable regulations. After neutralization and inspection, larger spills diluted with water must be disposed of in accordance with applicable regulations.

**Handling and storage:**

- Store in cool, dry and well-ventilated rooms with impermeable surfaces and appropriate containment conditions in case of leakage.
- Protect from adverse weather conditions and separate from incompatible materials during storage and transport.
- A sufficient supply of water must be located nearby.
- Prevent damage to containers in which batteries and rechargeable batteries are stored and transported.
- Keep away from fire, sparks and heat.

## 4.2.6.6 5CAUPS.xxxx-01

### 4.2.6.6.1 General information

The UPS connection cable establishes the connection between the UPS interface option and battery unit.

### 4.2.6.6.2 Order data

Order number	Short description	Figure
	<b>Uninterruptible power supply</b>	
5CAUPS.0005-01	UPS cable - 0.5 m - For 5AC901.IUPS-xx	
5CAUPS.0010-01	UPS cable - 1 m - For 5AC901.IUPS-xx	
5CAUPS.0013-01	UPS cable - 1.3 m - For 5AC901.IUPS-xx	
5CAUPS.0030-01	UPS cable - 3 m - For 5AC901.IUPS-xx	

### 4.2.6.6.3 Technical data

#### Information:

The following specified characteristic data, features and limit values are only valid for this accessory and may differ from those of the complete system. The data specified for the complete system applies to the complete system in which this accessory is installed, for example.

Order number	5CAUPS.0005-01	5CAUPS.0010-01	5CAUPS.0013-01	5CAUPS.0030-01
<b>General information</b>				
Certifications				
CE	Yes			
UL	cULus E115267 Industrial control equipment			
HazLoc	cULus HazLoc E180196 Industrial control equipment for hazardous locations Class I, Division 2, Groups ABCD, T4 <sup>1)</sup>			
<b>Cable construction</b>				
Wire cross section	2x 0.5 mm <sup>2</sup> (20 AWG) 2x 2.5 mm <sup>2</sup> (13 AWG)			
Conductor resistance	At 0.5 mm <sup>2</sup> max. 39 Ω/km At 2.5 mm <sup>2</sup> max. 7.98 Ω/km <sup>2)</sup>			
Outer jacket				
Material	Thermoplastic PVC-based material			
Color	Window gray (similar to RAL 7040)			
<b>Connector</b>				
Type	4-pin screw clamp terminal block <sup>3)</sup>			
<b>Electrical properties</b>				
Operating voltage	Max. 30 VDC			
Peak operating voltage	Typ. 30 VDC			
Test voltage				
Wire - Wire	1500 V			
Current-carrying capacity	10 A at 20°C			
<b>Operating conditions</b>				
Pollution degree per EN 61131-2	Pollution degree 2			
<b>Ambient conditions</b>				
Temperature				
Moving	-5 to 70°C			
Static	-30 to 70°C			
<b>Mechanical properties</b>				
Dimensions				
Length	0.5 m	1 m	1.3 m	3 m
Diameter	7 mm			
Bend radius				
Moving	10x wire diameter		10x line diameter	10x wire diameter
Fixed installation	5x wire diameter		5x line diameter	5x wire diameter
Weight	Approx. 55 g	Approx. 100 g	Approx. 130 g	Approx. 250 g

- 1) Yes, but applies only if all components installed in the complete system have this certification and the complete system bears the corresponding mark.
- 2) At an ambient temperature of 20°C.
- 3) Tightening torque: Min. 0.4 Nm, max. 0.5 Nm

**Information:**

The maximum length of the UPS connection cable depends on the following:

- Power output
- Voltage drop
- Wire cross section
- Sensor line

**4.2.6.6.4 Installation**

For information about connecting the cable to the battery unit, see section ["Installing and connecting the UPS battery unit" on page 225](#).

## 4.2.7 Front covers

### 4.2.7.1 5ACCF01.0000-00x

#### 4.2.7.1.1 General information

3 front cover variants are available for APC3100 system units.

#### Information:

The front cover cannot be ordered as an individual component; it is part of the complete system.

If a front cover is not selected during standard device configuration, then front cover 5ACCF01.0000-000 (orange APC3100 front cover with B&R logo) is installed and delivered by default.

#### 4.2.7.1.2 Order data

Order number	Short description	Figure
	<b>Front covers</b>	
5ACCF01.0000-000	APC3100 front cover - Orange - With B&R logo	
5ACCF01.0000-001	APC3100 front cover - Dark gray - Without logo	
5ACCF01.0000-002	APC3100 front cover - Orange - Without logo	

#### 4.2.7.1.3 Technical data

#### Information:

The following specified characteristic data, features and limit values are only valid for this accessory and may differ from those of the complete system. The data specified for the complete system applies to the complete system in which this accessory is installed, for example.

Order number	5ACCF01.0000-000	5ACCF01.0000-001	5ACCF01.0000-002
<b>General information</b>			
Certifications			
CE	Yes		
UL	cULus E115267 Industrial control equipment		
HazLoc	cULus HazLoc E180196 Industrial control equipment for hazardous locations Class I, Division 2, Groups ABCD, T4 <sup>1)</sup>		
DNV	Temperature: <b>B</b> (0 - 55°C) Humidity: <b>B</b> (up to 100%) Vibration: <b>A</b> (0.7 g) EMC: <b>B</b> (bridge and open deck) <sup>2)</sup>		
EAC	Product family certification		
<b>Mechanical properties</b>			
Housing			
Front cover	Dyed orange plastic (similar to Pantone 144CV)	Dyed dark gray plastic (similar to Pantone 432C)	Dyed orange plastic (similar to Pantone 144CV)
Logo	B&R logo	-	
Material	Plastic (PPE + PS)		
Weight	Approx. 30 g		

- 1) Yes, but applies only if all components installed in the complete system have this certification and the complete system bears the corresponding mark.
- 2) Yes, but applies only if all components installed in the complete system have this certification and are listed on the associated DNV certificate for the product family.

## 4.2.8 Key covers

### 4.2.8.1 5ACCBC01.0000-00x

#### 4.2.8.1.1 General information

2 key cover variants are available for APC3100 system units.

#### Information:

The key cover is part of the complete system and cannot be ordered as an individual component.

If a key cover is not selected during standard device configuration, then key cover 5ACCBC01.0000-000 (orange APC3100 key cover) is installed and delivered by default.

#### 4.2.8.1.2 Order data

Order number	Short description	Figure
	<b>Key covers</b>	
5ACCBC01.0000-000	APC3100 key cover - Orange	
5ACCBC01.0000-001	APC3100 key cover - Dark gray	

#### 4.2.8.1.3 Technical data

#### Information:

The following specified characteristic data, features and limit values are only valid for this accessory and may differ from those of the complete system. The data specified for the complete system applies to the complete system in which this accessory is installed, for example.

Order number	5ACCBC01.0000-000	5ACCBC01.0000-001
<b>General information</b>		
Certifications		
CE	Yes	
UL	cULus E115267 Industrial control equipment	
HazLoc	cULus HazLoc E180196 Industrial control equipment for hazardous locations Class I, Division 2, Groups ABCD, T4 <sup>1)</sup>	
DNV	Temperature: <b>B</b> (0 - 55°C) Humidity: <b>B</b> (up to 100%) Vibration: <b>A</b> (0.7 g) EMC: <b>B</b> (bridge and open deck) <sup>2)</sup>	
EAC	Product family certification	
<b>Mechanical properties</b>		
Housing		
Front cover	Dyed orange plastic (similar to Pantone 144CV)	Dyed dark gray plastic (similar to Pantone 432C)
Material	Plastic (PPE + PS)	
Weight	Approx. 9 g	

- 1) Yes, but applies only if all components installed in the complete system have this certification and the complete system bears the corresponding mark.
- 2) Yes, but applies only if all components installed in the complete system have this certification and are listed on the associated DNV certificate for the product family.

### 4.2.9 CFast cards

For detailed information about compatible CFast cards, see the [aggregate data sheet for CFast cards](#) on the B&R website.

# 5 Installation and wiring

---

## 5.1 Basic information

**A damaged device has unpredictable properties and states. The unintentional installation or startup of a damaged device must be prevented. The damaged device must be marked as such and made inaccessible, or it must be returned for repairs immediately.**

### Unpacking

The following activities must be performed before unpacking the device:

- Check the packaging for visible transport damage.
- If transport damage is noticeable, document this immediately and submit a complaint. If possible, have the damage confirmed by the carrier/delivery service.
- Check the contents of the shipment for completeness and damage.
- If the contents of the packaging are incomplete, damaged or do not correspond to the order, the responsible sales office or B&R Headquarters must be informed immediately.
- The information in section "[Protection against electrostatic discharge](#)" on page 11 must be observed for unpacked devices and components.
- Keep the original packaging for further transport.

### Power supply

The following information is generally applicable and should be observed before performing any work on the device:

- The entire power supply must be disconnected before removing any covers or components from the device and installing or removing any accessories, hardware or cables.
- Remove the power cable from the device and from the power supply.
- All covers and components, accessories, hardware and cables must be installed or secured before the device is connected to the power supply and switched on.

### Caution!

**Energy regeneration is not permitted and can cause damage or the device to become defective. Built-in or connected peripheral devices (e.g. USB hubs) are not permitted to introduce any voltage into the device.**

### Installation

#### Information:

**Optional sets are available that contain all necessary tools for installation. For additional information about tool sets, see section "[Installation accessories](#)" on page 228.**

#### Before installation

The following activities and limitations must be observed before installing the device.

- Allow sufficient space for installation, operation and maintenance of the device.
- The device must be installed on a flat, clean and burr-free surface.
- The wall or control cabinet plate must be able to support four times the total weight of the device. If necessary, bracing must be attached to reinforce the mounting surface.

### Caution!

**If the load-bearing capacity of the mounting surface is insufficient, or if the fastening material is inadequate or incorrect, the device may fall and become damaged.**

- To avoid overheating, the device is not permitted to be placed near other heat sources.



### Information about the device's environment

- Observe the notes and regulations regarding the power supply and functional ground.
- Observe the specified bend radius when connecting cables.
- Ventilation openings are not permitted to be covered or blocked.
- The device is only permitted to be operated in closed rooms and not permitted to be exposed to direct sunlight.
- The climatic and ambient conditions must be taken into account – see ["Environmental properties" on page 30](#).

### General installation instructions

- Inclined installation reduces the air convection through the device and thus the maximum permissible ambient temperature for operation. If there is sufficient external ventilation in an inclined mounting orientation, the maximum permissible ambient temperature must be checked in each individual case. Failure to do so may result in damage to the equipment and void the certifications and warranty for the device.
- When installing the device, the permissible mounting orientations must be observed - see ["Mounting orientations" on page 28](#).
- When installed in a closed housing, there must be sufficient volume for air circulation - see ["Spacing for air circulation" on page 27](#).
- When connecting installed or connected peripherals, follow the instructions in the peripheral device's documentation.

### Transport and storage

When transporting at low temperatures or in the event of large temperature fluctuations, the collection of moisture in or on the device is not permitted. Moisture can cause short circuits in electrical circuits and damage the device.

If a device is transported or stored without packaging, all environmental influences such as shocks, vibrations, pressure and moisture have an unprotected effect on the device. Damaged packaging indicates that the device has been severely affected by environmental influences and may have been damaged.

This can result in malfunctions of the device, machine or system.

### Use of third-party products

If third-party devices or components are used, the relevant manufacturer's documentation must be observed. If limitations or interactions by or with third-party products are possible, this must be taken into account in the application.

### 5.1.1 Installing the Automation PC

The Automation PC 3100 is installed using the mounting holes on the mounting plate. The holes are designed for M5 screws. The two M5 screws needed for this are not included in delivery.

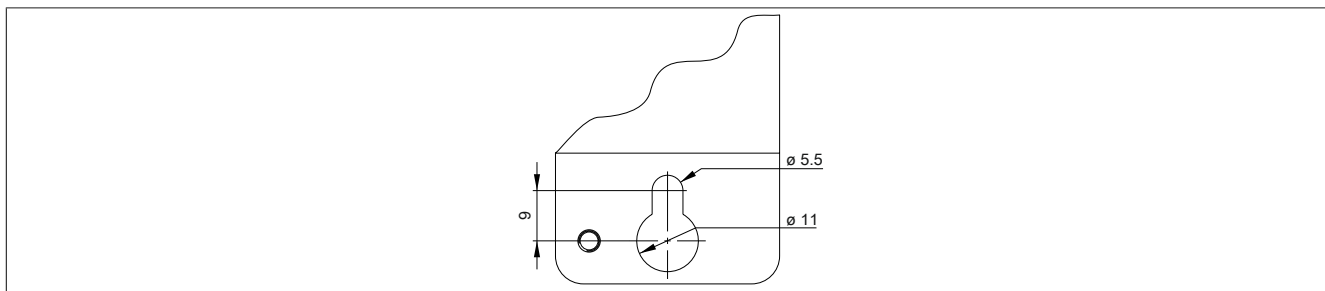

For the exact position of the mounting holes, see section "[Drilling template](#)" on page 26.

#### 5.1.1.1 Procedure

1. Provide the mounting surface with the necessary holes. For the exact position of the mounting holes, see the drilling templates.
2. Install the B&R industrial PC with M5 screws.

### 5.1.2 Installation information for individual deliveries / individual components

#### Information:

If the APC3100 is not delivered as a complete system but as individual deliveries (or individual components are installed afterward), it may be necessary to enable these components in BIOS. To do this, open BIOS during system startup, load the BIOS default values and restore and save any customized BIOS settings. For additional information, see section "[UEFI BIOS options](#)" on page 138. This may be required for the following individual components:

- Interface option
- Graphics option
- Mass storage option
- Main memory (DDR4 SDRAM)

## 5.2 Connecting to the power grid

### Danger!

- The entire power supply must be disconnected and electrostatic discharge must take place on the housing or ground connection before removing any covers or components from the device and installing or removing any accessories, hardware or cables.
- Remove the power cable from the device and from the power supply.
- All covers and components, accessories, hardware and cables must be installed or secured before the device is connected to the power supply and switched on.

### 5.2.1 Installing the DC power cable

### Danger!

The entire power supply to the B&R industrial PC or B&R Automation Panel must be interrupted. Before connecting the DC power cable, it must be checked whether it has been disconnected from the voltage source (e.g. power supply unit).

#### 5.2.1.1 Wiring

### Caution!

The pinout of the power supply interface must be observed!

The DC power cable must be implemented with a wire cross section of 0.75 mm<sup>2</sup> to 1.5 mm<sup>2</sup> and wire end sleeves.

Conductors of the power cable	Terminal connection symbol
+24 VDC	+
GND	⏏
0 VDC	-

#### Installing screw clamp terminal block 0TB103.9

Secure the conductors with wire end sleeves ① in the terminal contacts ③ as shown in the figure below and tighten the screw clamp terminals ④ with a screwdriver (max. tightening torque 0.4 Nm). It is important to pay attention to the label on the spring clamp terminal ②.

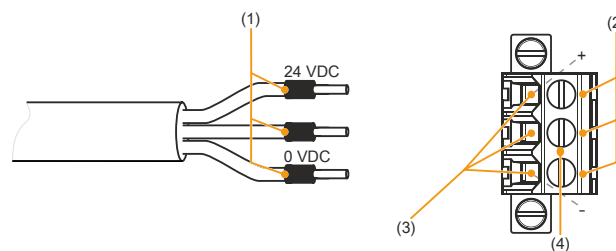

#### Installing cage clamp terminal block 0TB103.91

Insert a screwdriver into the cage clamp terminals ③ and secure the conductors with wire end sleeves ① in the terminal contacts ② as shown in the figure below. Close the terminal contact by removing the screwdriver. It is important to pay attention to the label on the spring clamp terminal ④.

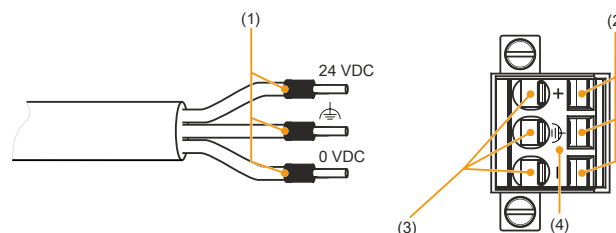

### 5.2.2 Connecting the power supply to a B&R device

#### Danger!

The entire power supply to the B&R device must be interrupted. Before connecting the power cable, it must be checked whether it has been disconnected from the voltage source (e.g. power supply unit).

1. Carry out electrostatic discharge on the housing or at the ground connection.
2. Connect the power supply connector to the B&R device and tighten the mounting screws (max. tightening torque 0.5 Nm).

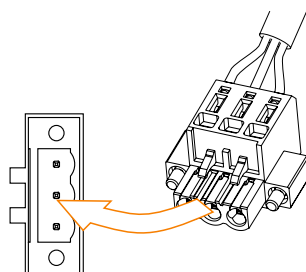

### 5.2.3 Grounding concept - Functional ground

Functional ground is a current path of low impedance between circuits and ground. It is used to improve immunity to interference, for example, and not as a protective measure. It serves only to divert interference, not to protect against contact with persons.

The device is equipped with 2 functional ground connections:

- Functional ground connection of the power supply
- Ground connection

The following points must be observed to ensure that electrical interference is safely diverted:

- Connect the device to the central grounding point (e.g. the control cabinet or the system) using the shortest possible low-resistance path.
- Cable design with at least 2.5 mm<sup>2</sup> per connection. If a cable with wire end sleeve is used with terminal block 0TB103.9 or 0TB103.91, a cable with a maximum of 1.5 mm<sup>2</sup> per connection is possible.
- Observe the shielding concept of the conductors. All data cables connected to the device must be shielded.

The functional ground on the B&R device is marked with the following symbol:

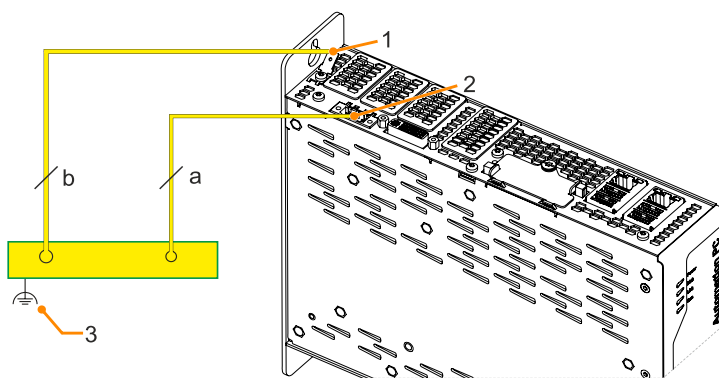

Legend			
1	Ground connection	2	Power supply connection +24 VDC pin 2
a	At least 1.5 mm <sup>2</sup>	3	Central grounding point
	b		At least 2.5 mm <sup>2</sup>

## 5.2.4 Connecting cables

When connecting or installing cables, the bend radius specification must be observed. For this specification, see the technical data of the respective cable. The maximum tightening torque of the locating screws is 0.5 Nm.

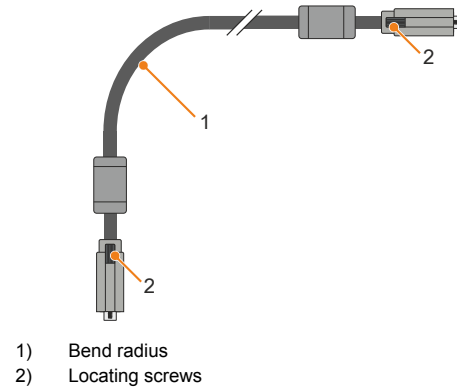

# 6 Commissioning

---

## 6.1 Basic information

**Before the device is started up, it must be gradually adapted to room temperature!**

## 6.2 Switching on the device for the first time

### 6.2.1 General information before switching on the device

#### Checklist

Before the device is started up for the first time, the following points must be checked:

- Have the installation instructions been observed as described in "[Installation and wiring](#)" on page 128?
- Have the permissible ambient conditions and environmental conditions for the device been taken into account?
- Is the power supply connected correctly and have the values been checked?
- Is the ground cable correctly connected to the ground connection?
- Before installing additional hardware, the device must have been started up.

#### Caution!

**Before the device is started up, it must be gradually adapted to room temperature! Exposure to direct heat radiation is not permitted.**

**When transporting at low temperatures or in the event of large temperature fluctuations, the collection of moisture in or on the device is not permitted.**

**Moisture can cause short circuits in electrical circuits and damage the device.**

#### Requirements

The following criteria must be met before switching on the device for the first time:

- The functional ground connections are as short as possible and connected to the central grounding point using the largest possible wire cross section.
- All connection cables are connected correctly.
- A USB keyboard and USB mouse are connected (optional).

### 6.2.2 Switching on the device

#### Procedure

1. Connect the power supply and switch it on (e.g. power supply unit).
2. The device is operating and boots; LED *Power* lights up.

## 6.3 General instructions for the temperature test procedure

The purpose of these instructions is to explain the general procedure for application-specific temperature tests with B&R industrial PCs or Power Panels. These instructions are only guidelines, however.

### 6.3.1 Procedure

In order to obtain meaningful results, the test conditions should correspond to conditions in the field. This means that during the temperature tests, for example, the target application should be running and the PC should be installed in the control cabinet housing that will be used later.

In addition, a temperature sensor should be installed for the device being tested in order to continuously monitor the ambient temperature. To obtain correct values, it must be installed at a distance of approx. 5 to 10 cm from the B&R industrial PC near the air inlet (not near the air outlet).

Every B&R industrial PC or Power Panel is equipped with internal temperature sensors. Depending on the device family, these are installed in different positions. The number and temperature limits vary depending on the device family.

For position specifications of the temperature sensors and their maximum specified temperatures, see section "Temperature sensor positions" on page 34.

A minimum test time of 8 hours is recommended for to optimally determine and assess the temperature situation.

### 6.3.2 Evaluating temperatures in Windows operating systems

#### 6.3.2.1 Evaluating with the ADI Control Center

The *ADI Control Center* can be used to evaluate temperatures. The temperatures can be viewed in tab **Temperatures**. The ADI Control Center can be downloaded from the B&R website ([www.br-automation.com](http://www.br-automation.com)) at no cost and uses the ADI (Automation Device Interface).

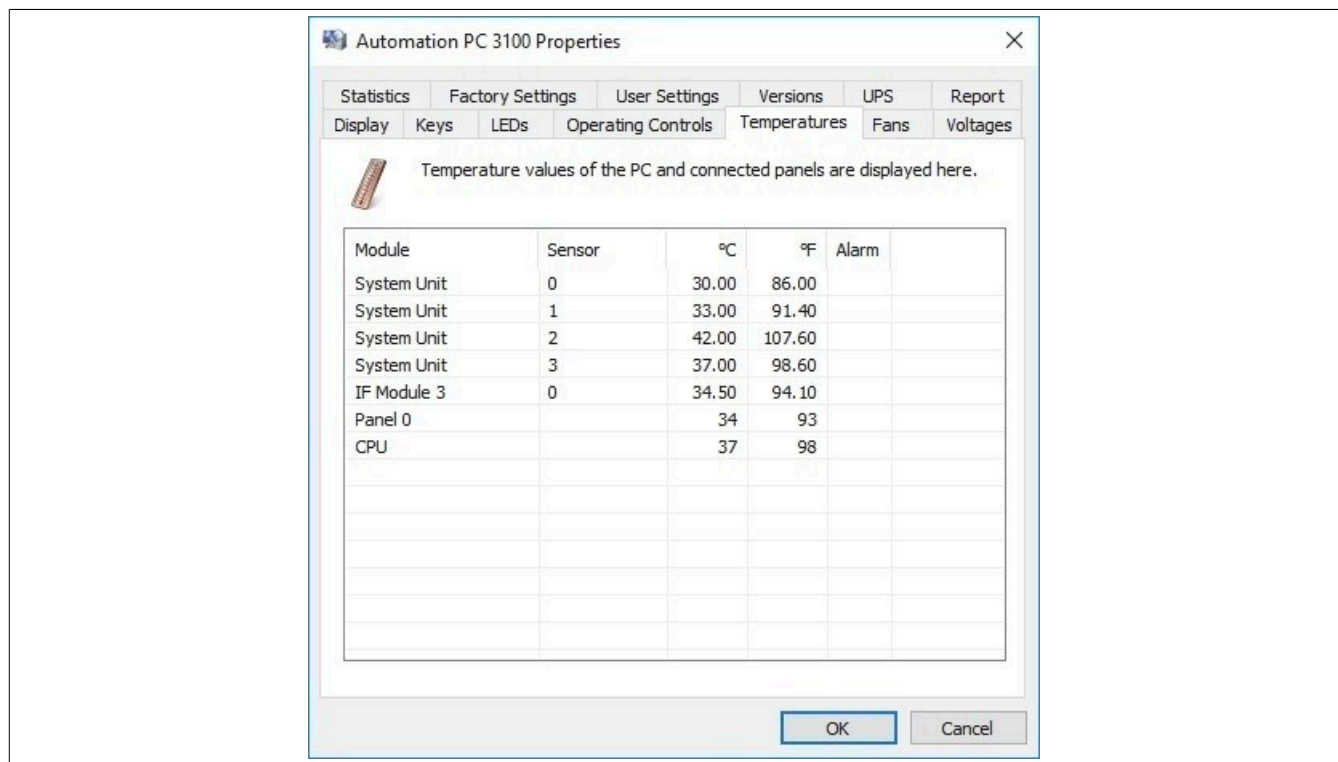

Figure 3: Displaying temperature values in the ADI Control Center

If historical recording of the data is necessary, a separate application can be created.

#### Information:

To create a separate application, downloads such as the ADI .NET SDK are available from the B&R website ([www.br-automation.com](http://www.br-automation.com)).

### 6.3.2.2 Evaluation with BurnInTest from PassMark

If a separate application is not created or used for temperature evaluation, B&R recommends using the BurnInTest software tool from PassMark.

The BurnInTest software tool is available in standard and professional versions. In addition to the software package, various loopback adapters (serial, parallel, USB, etc.) and test CDs or DVDs are also available. Depending on the expansion level of the software and available loopback adapters, a correspondingly high system and peripheral load can be generated.

#### Information:

**Loopback adapters are also available from PassMark. For additional information, see [www.pass-mark.com](http://www.pass-mark.com).**

The following screenshots refer to PassMark BurnInTest Pro V7.1 using a APC3100 without IF options.

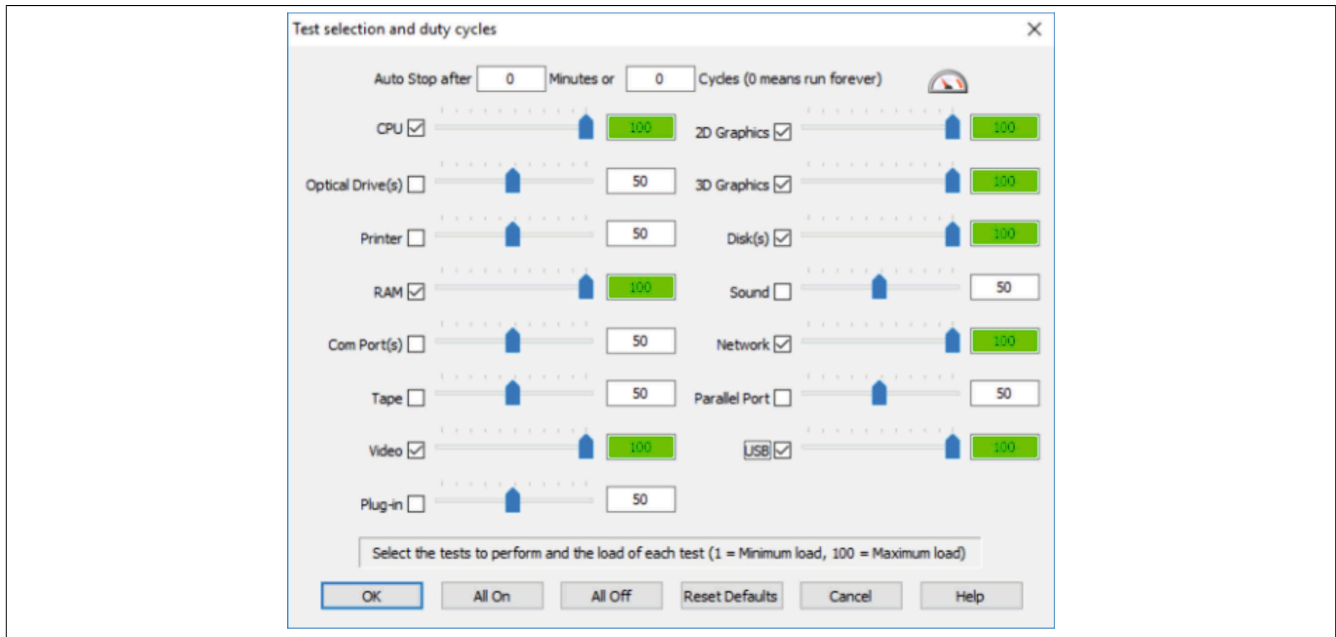

Figure 4: Settings for PassMark BurnInTest Pro V7.1 using an APC3100 without IF options

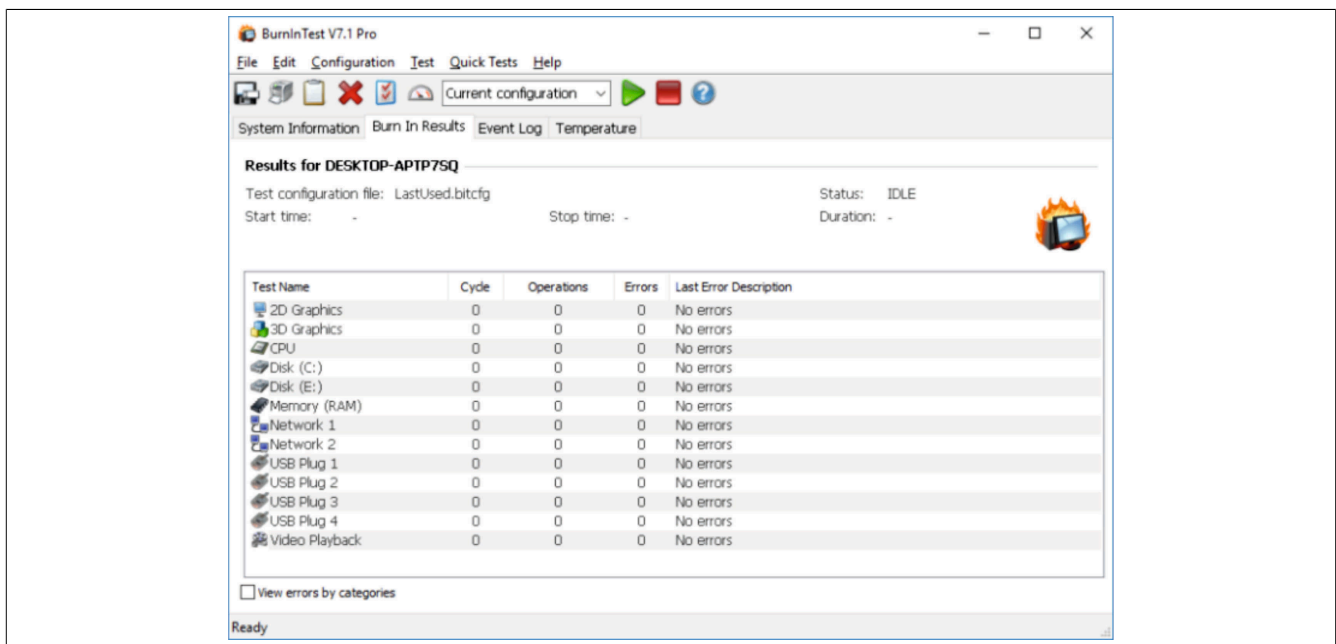

Figure 5: Test overview of an APC3100 without IF options

Depending on the availability of the loopback adapters and DVDs, appropriate fine tuning must be carried out in the respective test properties.



## Information:

If no USB loopback adapters are available, USB flash drives can also be used. The USB flash drives must be available in Windows as formatted drives. Option "USB" must then be deselected in the test configuration, and the USB flash drives must be configured as test devices in the disk properties.



## Information:

Serial loopback adapters can be created relatively easily by yourself. Just connect some pins with wires on the serial interface.

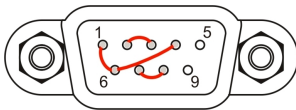

### 6.3.3 Evaluating the measurement results

The recorded maximum temperature value of each individual sensor is not permitted to exceed the temperature limit specified in the user's manuals.

If the temperature tests cannot be carried out in a climate chamber, they can be carried out in an office environment, for example. It is necessary to record the ambient temperature, however. Based on experience gained at B&R, the measured temperature values can be extrapolated linearly to the ambient temperature for passive systems (systems without a fan kit). In order to also be able to extrapolate the temperature values for systems with a fan kit, the fans must be running. The speed, etc. must also be taken into account.

If the temperature tests are carried out in a controlled climate chamber with a fan, the devices to be tested are cooled by this fan and thus the measurement results are distorted. With passive devices, the measurement results are therefore unusable. In order to be able to carry out temperature tests in climate chambers with fans without distorting the measurement results, however, the fan of the climate chamber must be switched off and a correspondingly long lead time (several hours) must be observed.

### 6.4 Known problems / Characteristics

- USB 2.0 transfer is limited to 150 Mbit/s with SDL4.
- A display is always emulated by the SDL4 transmitter using EDID data and hot plug detection, so DVI-compatible operation is possible. For this reason, the following behavior may occur during operation with multiple displays.

In the operating system, a connected panel is reported by the video driver even in the following situations:

- No SDL3/SDL4 cable is connected.
- There is no connection established yet between the SDL4 link module and SDL4 transmitter.

This behavior can be avoided by appropriate configuration in BIOS or via the graphics driver.

- If problems occur with the ETH1 or ETH2 interface (connection abort, slow data transfer, etc.), the Energy-Efficient Ethernet feature can be disabled in the driver as a possible solution.

# 7 Software

---

## 7.1 UEFI BIOS options

### 7.1.1 General information

The Unified Extensible Firmware Interface (UEFI) and its predecessor, Extensible Firmware Interface (EFI), establish the basic standardized connection between the user and the system (hardware and firmware), individual components of a computer and the operating system. This B&R industrial PC uses UEFI BIOS from the Insyde Software corporation.

The UEFI BIOS Setup Utility makes it possible to modify basic system configuration settings. These settings are stored in a flash block.

#### **Information:**

**The following BIOS settings are system-optimized. Changes to these settings should only be made by system experts who are aware of the effects of the modification.**

#### 7.1.1.1 Adaptation for touch operation

The BIOS used for the APC3100/PPC3100 was developed with touch screen systems in mind. Compared to other or older B&R systems, the user interface, especially buttons and selection fields, is therefore larger. In addition, the setting and configuration options are divided into separate submenu structures.

The APC3100/PPC3100 can still be used with ordinary displays and operator panels without any limitation on usability, however.

##### 7.1.1.1.1 Operation

During touch operation, the system does not display a mouse pointer. If operation is carried out using an external operating device, the mouse pointer is displayed. Both input methods can be used simultaneously; the system automatically displays or hides the mouse pointer.

If keyboard entry is required, a keyboard appears on the display that can be operated via touch screen or mouse. All keyboard entries can also be made with an external keyboard.

#### 7.1.1.2 Overview of BIOS description

#### **Information:**

**This description is for the full extent of version 1.25.**

*Selection and setting options as well as the menu structure and display may differ slightly depending on the device series, system configuration, BIOS version and BIOS settings that have already been made. The figures in the following section are symbolic.*

For simplification purposes, only setting option **[Enter]** is explicitly listed below. All settings can also be made via mouse click or touch screen.

These figures are only excerpts from the respective menus. A complete list of all parameters and menus is available in a table in each section.

Depending on the display system used, it is possible to navigate to all menus on the device using the slide bar or mouse and keyboard input.

Variables written in italics (*n*) are used to maintain clarity and to summarize different menus that have the same setting options. When first mentioned, their range of values is defined and, if necessary, further notes are listed. *n* within a certain range of values of a certain BIOS setting is only valid for this parameter. Each combination of "[BIOS parameter]" and "*n*" is defined independently.

Entries outside a specified range of values are not applied.

Default values are marked bold and italic in column "Input options" in tables.  
Submenus are bold in column "BIOS parameter" in tables.

BIOS parameter		Input options	Description
BIOS parameter 1		<b><i>Enable(d)</i></b> Disable(d)	Disables/Enables BIOS parameter 1
BIOS parameter 1 value		UINT Default: <b><i>42</i></b>	Defines the value of BIOS parameter 1 Range: 0 to 65535 Resolution: 3
BIOS parameter 2		-	Displays BIOS parameter 2
	BIOS parameter 2.1	a1 <b><i>a2</i></b> b	Selects mode of BIOS parameter 2.1
	BIOS subparameter 2.1 value	<b><i>Disable(d)</i></b> Enable(d)	Disables/Enables BIOS subparameter 2.1
BIOS parameter <i>n</i> <sup>1)</sup>		<b><i>Disable(d)</i></b> (Various) <sup>2)</sup>	Disables BIOS parameter <i>n</i> or selects option
<b>Hardware components</b>		Enter	Opens submenu "Hardware components" on page xyz

Table 65: Main menu - Menu - Submenu(s)

- 1) The 16 possible parameters are indexed from 0 to 15.
- 2) Setting option "(Various)" combines different values/modes with different dependencies.

## 7.1.2 BIOS Setup and startup procedure

UEFI BIOS is enabled immediately after switching on the B&R industrial PC. A check takes place as to whether the setup data from the FLASH block is OK. If it is OK, the boot procedure is started. If it is not OK, the setup default settings are loaded and the boot procedure is continued.

UEFI BIOS reads the system configuration information, checks the system and configures it through the power-on self-test (POST).

UEFI BIOS then searches the data storage media in the system (CFast cards, USB mass storage devices, SSD, HDD, etc.) for an operating system. UEFI BIOS starts the operating system and transfers to it control over system operations.

To enter UEFI BIOS Setup, **[Esc]**, **[Del]** or **[F2]** must be pressed after initializing the USB controller when the following message appears on the screen (during POST): *Press ESC / DEL / F2 to enter Setup.*

If a B&R panel with touch sensor is used during device configuration, Setup can be opened by quickly tapping the upper edge of the touch area.



### 7.1.2.1 Input options

#### Power-on self-test (POST)

The following keys are enabled during POST:

Keys	Function
Esc, Del, F2	Accesses the BIOS Setup menu or boot manager.
<Pause>	The POST can be stopped with the <Pause> button. POST resumes after pressing any other key.

#### Information:

The key signals of the USB keyboard are only processed after the USB controller is initialized.

#### Boot menu

The following keys are enabled during POST:

Key	Function
F1	Help
ESC	Exits the help documentation
Cursor keys (←, ↑, ↓, →)	Navigation in the boot menu
Enter	Opens the selected submenu

#### BIOS Setup

The following keys can be used after entering BIOS Setup:

Key	Function
F1	Help
ESC	Exits
Cursor keys (←, ↑, ↓, →)	Navigation in the menu
Page ↑, Page ↓	Press once: Cursor jumps to first/last line in the display area Press twice: Cursor jumps to first/last item in the menu
F5	Changes a value (step back)
F6	Changes a value (step forward)

Key	Function
F9	Loads the default settings <sup>1)</sup>
F10	Saves and closes
Enter	Opens the selected submenu/parameter
Alphanumeric keys	Defines manual values for parameters that permit this

1) Save and close to restore the default values.

## Information:

**All manual changes are overwritten if the default values are loaded and saved.**

### 7.1.3 Boot menu



Boot menu option	Description
Continue	Resumes the boot process.
Boot manager	Lists all detected and bootable media. See " <a href="#">Boot manager</a> " on page 143.
Device management	Lists all supported and enabled devices (e.g. RAID and Ethernet). See " <a href="#">Device manager</a> " on page 144.
Boot from file	Selects a bootable file to boot from. Depending on the boot configuration, the files can also be stored on external storage media.
Administer Secure Boot	For a detailed description of this option, see the user documentation from the operating system manufacturer.
Setup utility	Performs advanced configurations. See " <a href="#">Setup utility</a> " on page 146.

Table 66: Boot menu

## 7.1.4 Boot manager

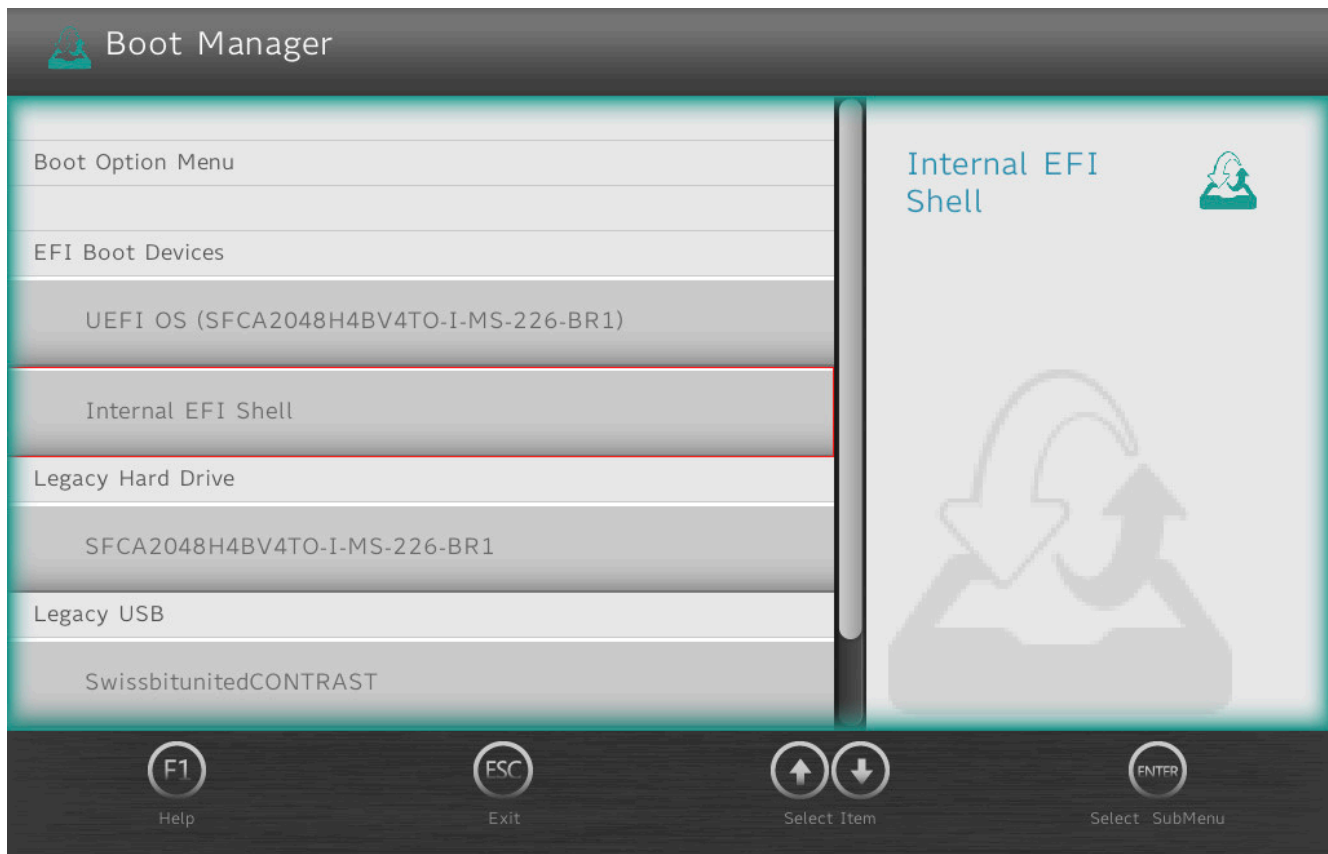

The boot manager lists all detected and bootable legacy or UEFI media. It is possible to select the media from which the boot procedure should be performed.

## 7.1.5 Device manager

### Information:

For detailed instructions on how to create a RAID volume, see section "RAID configuration" on page 183.

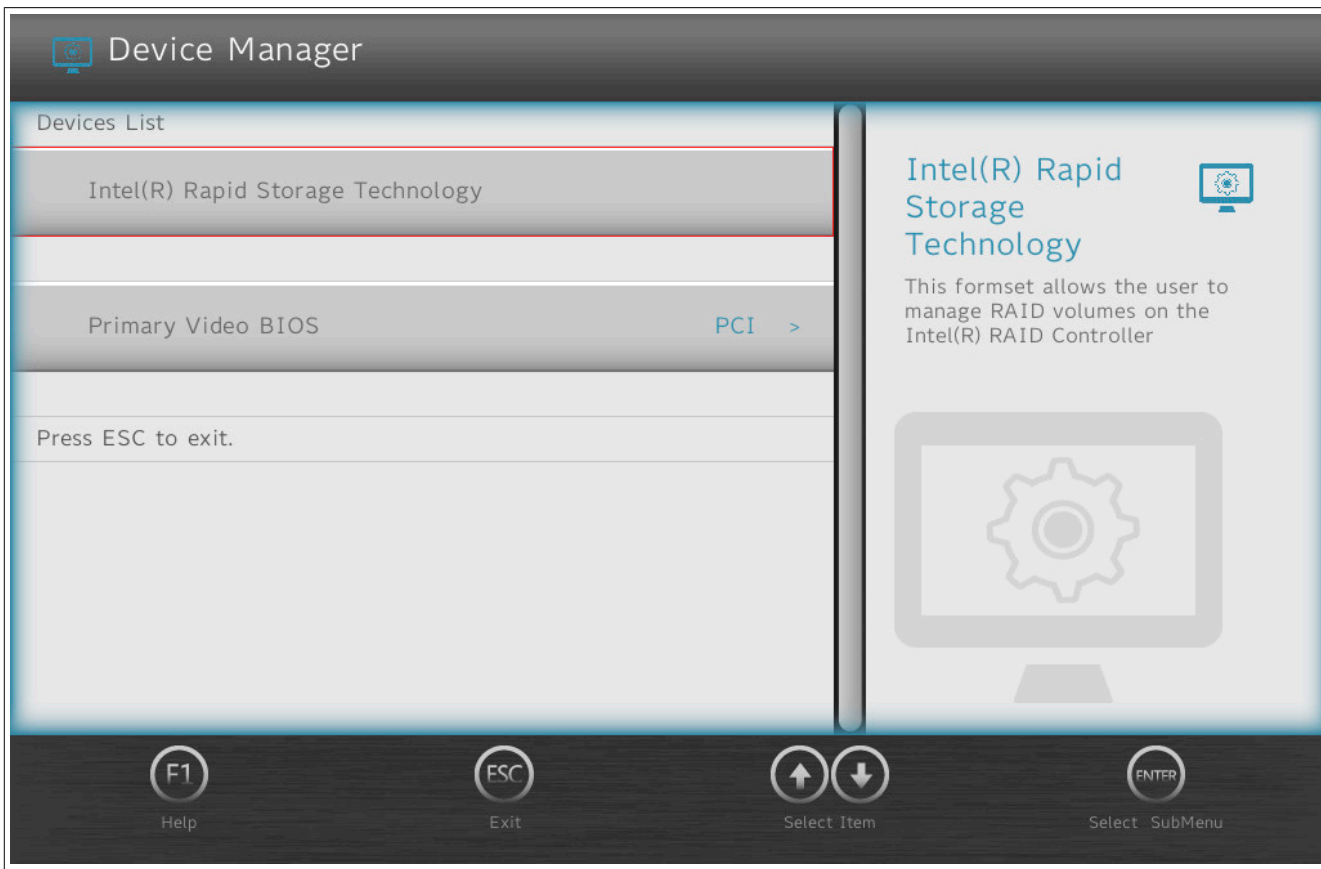

BIOS parameter	Setting options	Description
Intel® Rapid Storage Technology	Enter	Opens submenu "Intel® Rapid Storage Technology" on page 144
Primary video BIOS	PCI AGP	Selects the primary video BIOS

Table 67: Device manager

### 7.1.5.1 Intel® Rapid Storage Technology

BIOS parameter	Setting options	Description
Intel® RST (...) RAID driver	-	Displays the version of the Intel RST RAID driver
Create RAID volume	Enter	Opens submenu "Create RAID volume" on page 144
Non-RAID physical disks:		
Disk <i>n</i> <sup>1)</sup>	Enter	Opens submenu "Disk <i>n</i> " on page 145
RAID volumes: <sup>2)</sup>		
Volume1	Enter	Opens submenu "RAID volume info" on page 145

Table 68: Device manager - Intel® Rapid Storage Technology

- "Disk *n*" is a placeholder. This BIOS parameter displays a subset of the values that are listed in more detail in the corresponding submenu.
- Requires an existing RAID volume.

Its name can be defined during creation (see "Create RAID volume" on page 144). **Volume1** is used as the default value.

#### 7.1.5.1.1 Create RAID volume

BIOS parameter	Setting options	Description
Name:	String Default: <b>Volume1</b>	Name for the RAID volume No special characters are permitted. Range: Max. 16 characters
RAID level:	<b>RAID0 (stripe)</b> RAID1 (mirror) Recovery	Selects the RAID level

Table 69: Device manager - Create RAID volume



BIOS parameter	Setting options	Description
Select disks:		
Disk n:	(Blank) X M R	Selects the storage medium for the RAID volume. Either X (RAID0 and RAID1) or M (master) /R (recovery) can be defined (recovery mode).
Stripe size:	4 kB 8 kB <b>16 kB</b> 32 kB 64 kB 128 kB	Selects the data block size [kB]
Capacity:	INT	Defines the RAID memory size [MB] Range: Hardware-dependent If storage media of different sizes are used, this is limited to the smaller medium.
Synchronization:	<b>Continuous</b> On request	Selects the synchronization mode

Table 69: Device manager - Create RAID volume

### 7.1.5.1.2 Disk *n*

BIOS parameter	Setting options	Description
Volume actions <sup>1)</sup>		
Reset to non-RAID <sup>1)</sup>	Enter	Resets the disk to non-RAID
Port:	-	Displays the port number of device <i>n</i>
Model number:	-	Displays the product ID of device <i>n</i>
Serial number:	-	Displays the serial number of device <i>n</i>
Size:	-	Displays the memory size of device <i>n</i>
Status:	-	Displays the RAID status of device <i>n</i>
Controller type:	-	Displays the controller of device <i>n</i>
Controller interface:	-	Displays the controller interface of device <i>n</i>

Table 70: Device manager - Intel® Rapid Storage Technology

1) Available only if the storage medium is part of a RAID volume.

### 7.1.5.1.3 RAID volume info

BIOS parameter	Setting options	Description
Volume actions		
Delete	Enter	Deletes the RAID volume
Enable master disk only	Enter	Enables only the master disk
Enable recovery disk only	Enter	Enables only the recovery disk
Name:	-	Displays the name of the RAID volume
RAID level:	-	Displays the RAID level of the volume
Strip size:	-	Displays the data block size [kB] of the volume
Size:	-	Displays the memory size [GB or TB] of the volume
Status:	-	Displays the status of the volume
Bootable:	-	Displays the bootability of the volume
<b>Disk <i>n</i></b> <sup>1)</sup>	Enter	Opens submenu "Disk <i>n</i> " on page 145

Table 71: Device manager - Intel® Rapid Storage Technology - RAID volume info

1) "Disk *n*" is a placeholder. This BIOS parameter displays a subset of the values that are listed in more detail in the corresponding submenu.

## 7.1.6 Setup utility

Settings can be made in the boot menu under **Setup utility**.

Submenu	Setting options	Description
Main	Enter	Opens submenu "Main" on page 146 Basic system information is displayed and the system time can be set here.
Advanced	Enter	Opens submenu "Advanced" on page 148 Changes to system settings can be made here.
Security	Enter	Opens submenu "Security" on page 172 Changes to the Trusted Platform Module can be made here. Passwords for storage media can be created and managed here.
Power	Enter	Opens submenu "Power" on page 174 Changes that affect the power consumption of the system can be made here.
Boot	Enter	Opens submenu "Boot" on page 175 Changes to the boot modes and boot sequence can be made here.
Exit	Enter	Opens submenu "Exit" on page 178 Changes can be discarded or saved here. User-specific default values can be saved and loaded here or system-optimized default values from B&R can be restored.

Table 72: Boot menu - Setup utility

### 7.1.6.1 Main

BIOS setting	Setting options	Description
BIOS version	-	Displays the BIOS version
Processor type	-	Displays the processor type
System bus speed	-	Displays the bus speed
System memory speed	-	Displays the data rate
Cache RAM	-	Displays the processor cache
Total memory	-	Displays the total RAM
Channel A		
SODIMM 0	-	Displays the amount of memory for channel A page 0
SODIMM 1	-	Displays the amount of memory for channel B page 1
Channel B		
SODIMM 0	-	Displays the amount of memory for channel A page 0
SODIMM 1	-	Displays the amount of memory for channel B page 1
Platform configuration		
CPUID	-	Displays the processor ID
CPU speed	-	Displays the processor speed [MHz]

Table 73: Main

BIOS setting	Setting options	Description
CPU stepping	-	Displays the stepping version of the processor
L1 data cache	-	Displays the L1 data cache [kB]
L1 instruction cache	-	Displays the L1 instruction cache [kB]
L2 cache	-	Displays the L2 cache [kB]
L3 cache	-	Displays the L3 cache [kB]
Number of processors	-	Displays the number of cores / number of threads
Microcode rev	-	Displays the microcode revision
GT info	-	Displays the name of the graphics processor (ID)
SMX / TXT	-	Displays SMX / TXT support
PCH rev / SKU	-	Displays the PCH revision / SKU
VBIOS ver	-	Displays the VBIOS version
GOP ver	-	Displays the GOP version
Intel ME version / SKU	-	Displays the Intel ME version
LAN PHY revision	-	Displays the LAN PHY revision
System time	INT	Adjusts the system time in the format hh:mm:ss
System date	INT	Adjusts the system date in the format yyyy:mm:dd
About this software	Enter	Displays the copyright disclaimer

Table 73: Main

## 7.1.6.2 Advanced



BIOS parameter	Setting options	Description
<b>OEM features</b>	Enter	Opens submenu "OEM features" on page 149
<b>USB configuration</b>	Enter	Opens submenu "USB configuration" on page 154
<b>Chipset configuration</b>	Enter	Opens submenu "Chipset configuration" on page 155
<b>ACPI settings</b>	Enter	Opens submenu "ACPI table/features control" on page 156
<b>CPU configuration</b>	Enter	Opens submenu "CPU configuration" on page 157
<b>Power &amp; Performance</b>	Enter	Opens submenu "CPU - Power management control" on page 158
<b>Memory configuration</b>	Enter	Opens submenu "Memory configuration" on page 162
<b>System agent (SA) configuration</b>	Enter	Opens submenu "System agent (SA) configuration" on page 164
<b>PCH-IO configuration</b>	Enter	Opens submenu "PCH-IO configuration" on page 166
<b>PCH-FW configuration</b>	Enter	Opens submenu "PCH-FW configuration" on page 171

Table 74: Advanced

## 7.1.6.2.1 OEM features



BIOS parameter	Setting options	Description
BIOS version	-	Displays the BIOS version
MTCX version	-	Displays the MTCX version
Realtime environment	<b>Disabled</b> Enabled	Disables/Enables the real-time environment This must be enabled for real-time operating systems such as Automation Runtime.
Hypervisor environment	<b>Disabled</b> Enabled	Disables/Enables the hypervisor environment Enabling is necessary for hypervisor operation. Parameters "VT-d" and "Intel (VMX) Virtualization Technology" are enabled and cannot be changed during hypervisor operation.
Automatic firmware update	<b>Disabled</b> Enabled	Disables/Enables automatic firmware updates for the mainboard, SDL and SDL4 cards
<b>Super IO</b>	Enter	Opens submenu "Super IO" on page 150
<b>H2OUVE</b>	Enter	Opens submenu "H2OUVE" on page 151
<b>Baseboard</b>	Enter	Opens submenu "Baseboard" on page 151
<b>Interface slot n<sup>(1) 2)</sup></b>	Enter	Opens submenu "Interface slot n" on page 151
<b>Panel settings</b>	Enter	Opens submenu "Panel settings" on page 152
<b>SSD monitoring service</b>	Enter	Opens submenu "SSD monitoring service" on page 152
<b>Custom boot logo</b>	Enter	Opens submenu "Custom boot logo" on page 153
<b>Backup settings</b>	Enter	Opens submenu "Backup settings" on page 153

Table 75: Advanced - OEM features

- 1) A total of 3 interface option slots are available. Slot IF option 3 is reserved for graphic interfaces.
- 2) Slots that are not used are not displayed.  
If no slot is used, this submenu is not available.

With BIOS V01.16, the behavior of parameters **Realtime environment** and **Hypervisor environment** has been updated (see option "d" in the following table).

This function is supported in Automation Studio 4.7 and later. Starting with this version, it is possible to configure hypervisor operation with or without hyperthreading for the GPOS (if the CPU used supports this).

Option	Realtime environment (RTE)	Hypervisor environment (HV)	Description
a)	Disabled	Disabled	The default settings are used.
b)	Enabled	Disabled	The system has full RTE support. Hyperthreading is disabled.
c)	Enabled	Enabled	The system has full RTE and AS support. Hyperthreading is disabled.
d)	Disabled	Enabled	The system has RTE and AS support. Hyperthreading is enabled.

If the complete system has been preconfigured for real-time and/or hypervisor operation, these parameters are system specifications and grayed out. Changes in BIOS Setup are then ineffective since they are overwritten by the system specifications during booting. In this case, configuration changes must be made in the EFI shell with tool *mtcxsvc.efi*, which is part of the firmware upgrades for xPC3100 systems (see "PC firmware upgrade" on page 180).

### 7.1.6.2.1.2 Super IO

BIOS parameter		Setting options	Description
CAN device		-	Indicates whether a CAN interface (IF option) is installed
COM A		Disable	Disables/Enables COM A (SDL onboard touch screen)
		<b>Enable</b>	
	Base I/O address	0x2E8	Selects the I/O address for COM A
		0x2F8	
		0x338	
		0x378	
		<b>0x3E8</b>	
		0x3F8	
Interrupt		IRQ 3	Selects the interrupt for COM A
		IRQ 4	
		IRQ 5	
		IRQ 7	
		<b>IRQ 11</b>	
MTCX interrupt		<b>Automatic</b>	Disables the MTCX interrupt or assigns it automatically if permitted by the system configuration (at least 1 IRQ free).
		Disable	

Table 76: Advanced - OEM features - Super IO

#### Note:

**COM B to COM E are only displayed if they are allocated.**

BIOS parameter		Setting options	Description
COM B		Disable	Disables/Enables COM B (LFP touch screen)
		<b>Enable</b>	
	Base I/O address	0x2E8	Selects the I/O address of port COM B
		<b>0x2F8</b>	
		0x338	
		0x378	
		0x3E8	
		0x3F8	
Interrupt		<b>IRQ 3</b>	Selects the interrupt for COM B
		IRQ 4	
		IRQ 5	
		IRQ 7	
		IRQ 11	
COM C		Disable	Disables/Enables COM C (IF option 1)
		<b>Enable</b>	
	Base I/O address	<b>0x2E8</b>	Selects the I/O address of port COM C
		0x2F8	
		0x338	
		0x378	
		0x3E8	
		0x3F8	
Interrupt		IRQ 3	Selects the interrupt for COM C
		IRQ 4	
		<b>IRQ 5</b>	
		IRQ 7	
		IRQ 11	
COM D		Disable	Disables/Enables COM D (IF option 2)
		<b>Enable</b>	
	Base I/O address	0x2E8	Disables/Enables the I/O address of port COM D
		0x2F8	
		<b>0x338</b>	
		0x378	
		0x3E8	
		0x3F8	
Interrupt		IRQ 3	Selects the interrupt for COM D
		IRQ 4	
		IRQ 5	
		<b>IRQ 7</b>	
		IRQ 11	

Table 77: Advanced - OEM features - Super IO (supplement)

BIOS parameter		Setting options	Description			
COM E		Disable <b>Enable</b>	Disables/Enables COM E (graphics option IF3)			
Base I/O address	0x2E8 0x2F8 0x338 0x378 0x3E8 <b>0x3F8</b>	Selects the I/O address of port COM E				
				Interrupt	IRQ 3 <b>IRQ 4</b> IRQ 5 IRQ 7 IRQ 11	Selects the interrupt for COM E

Table 77: Advanced - OEM features - Super IO (supplement)

### 7.1.6.2.1.3 H2OUVE

BIOS parameter	Setting options	Description
H2OUVE support	<b>Disabled</b> Enabled	Disables/Enables H2OUVE support

Table 78: Advanced - OEM features - H2OUVE

### 7.1.6.2.1.4 Baseboard

BIOS parameter	Setting options	Description
Product name	-	Displays the B&R order number of the mainboard
Serial number	-	Displays the B&R serial number of the mainboard
Device ID	-	Displays the device ID of the mainboard
Vendor ID	-	Displays the vendor ID of the mainboard
Compatibility ID	-	Displays the compatibility ID of the mainboard
HW revision	-	Displays the hardware revision of the mainboard
Parent device ID	-	Displays the parent device ID of the mainboard
Parent comp. ID	-	Displays the parent compatibility of the mainboard
ETH1 MAC address	-	Displays the ETH1 MAC address
ETH2 MAC address	-	Displays the ETH2 MAC address
Power on cycles <sup>1)</sup>	-	Displays the power-on cycles of the mainboard
Power on hours	-	Displays the operating time [h] of the mainboard
Battery voltage	-	Displays the battery voltage [V]
Battery state	-	Displays the battery state
Temperature 1	-	Displays the current temperature at sensor 1 [°C and °F]
Temperature 2	-	Displays the current temperature at sensor 2 [°C and °F]
Temperature 3	-	Displays the current temperature at sensor 3 [°C and °F]
Temperature 4	-	Displays the current temperature at sensor 4 [°C and °F]

Table 79: Advanced - OEM features - Baseboard

1) Each start/restart increases the value by 1.

### 7.1.6.2.1.5 Interface slot *n*

A total of 3 interface option slots are available. They are indexed from 1 to 3.

BIOS parameter	Setting options	Description
Product name	-	Displays the B&R order number of IF option <i>n</i>
Serial number	-	Displays the B&R serial number of IF option <i>n</i>
Device ID	-	Displays the device ID of IF option <i>n</i>
Vendor ID	-	Displays the vendor ID of IF option <i>n</i>
Compatibility ID	-	Displays the compatibility ID of IF option <i>n</i>
HW revision	-	Displays the hardware revision of IF option <i>n</i>
FW version <sup>1)</sup>	-	Displays the firmware version of IF option <i>n</i>
Parent device ID	-	Displays the parent device ID of IF option <i>n</i>
Parent comp. ID	-	Displays the parent compatibility ID of IF option <i>n</i>
Power on cycles <sup>2)</sup>	-	Displays the power-on cycles of IF option <i>n</i>
Power on hours	-	Displays the operating time [h] of IF option <i>n</i>
Temperature <i>q</i> <sup>3)</sup>	-	Displays the temperature at sensor <i>q</i> [°C and °F]

Table 80: Advanced - OEM features - Interface slot *n*

1) For graphics options only.

2) Each start/restart increases the value by 1.

3) The number of temperature sensors varies depending on the interface option. If no temperature sensor is available, the parameter is not displayed.

### 7.1.6.2.1.6 Panel settings

BIOS parameter	Setting options	Description
Panel <i>n</i> <sup>1)</sup>	Enter	Opens menu "Panel <i>n</i> " on page 152

Table 81: Advanced - OEM features - Panel settings

1) The number of panels varies by system and system configuration (see submenu "Panel *n*" for reserved indices).

#### Panel *n*

The panel on the SDL/DVI-D interface of the APC3100/PPC3100 is indexed as panel 0.

If the APC3100/PPC3100 is also equipped with a graphics option in the IF option 3 slot, the associated panel is assigned index 8.

BIOS parameter	Setting options	Description
Product name	-	Displays the B&R order number of the panel
Serial number	-	Displays the B&R serial number of the panel
Device ID	-	Displays the device ID of the panel
Vendor ID	-	Displays the vendor ID of the panel
Compatibility ID	-	Displays the panel's compatibility ID
HW revision	-	Displays the hardware revision of the panel
Parent device ID	-	Displays the parent device ID of the panel
Parent compat. ID	-	Displays the parent compatibility ID of the panel
Backlight on cycles <sup>1)</sup>	-	Displays the backlight-on cycles of the panel
Backlight on hours	-	Displays the operating time of the backlight [h] for the panel
Power on cycles <sup>2)</sup>	-	Displays the power-on cycles of the panel
Power on hours	-	Displays the operating time [h] of the panel
Brightness	INT Default: <b>100</b>	Screen brightness of the panel [%] Range: 0 to 100 Resolution: 1%

Table 82: Advanced - OEM features - Panel settings - Panel *n*

- 1) Each time the backlight is switched on increases the value by 1.  
2) Each start/restart increases the value by 1.

### 7.1.6.2.1.7 SSD monitoring service

The following data is only displayed for B&R products. B&R cannot ensure this support for third-party products.

BIOS parameter	Setting options	Description
CFast 1		
Product name	-	Displays the product ID of CFast card 1
Serial number	-	Displays the manufacturer serial number of CFast card 1
Firmware version	-	Displays the firmware version of CFast card 1
SMART <sup>1)</sup> status	-	Displays the S.M.A.R.T. status of CFast card 1
WAF <sup>2)</sup>	-	Displays the WAF of CFast card 1
Average erase count	-	Displays the average number of erase operations on a block of CFast card 1
Remaining life	-	Displays the remaining life of CFast card 1 [%]
CFast 2		
Product name	-	Displays the product ID of CFast card 2
Serial number	-	Displays the manufacturer serial number of CFast card 2
Firmware version	-	Displays the firmware version of CFast card 2
SMART status	-	Displays the S.M.A.R.T. status of CFast card 2
WAF	-	Displays the WAF of CFast card 2
Average erase count	-	Displays the average number of erase operations on a block of CFast card 2
Remaining life	-	Displays the remaining life of CFast card 2 [%]
M.2		
Product name	-	Displays the product ID of the M.2 mass storage device
Serial number	-	Displays the manufacturer's serial number of the M.2 mass storage device
Firmware version	-	Displays the firmware version of the M.2 mass storage device
SMART status	-	Displays the S.M.A.R.T. status of the M.2 mass storage device
Remaining life	-	Displays the remaining life of the M.2 mass storage device [%]

Table 83: Advanced - OEM features - SSD monitoring service

- 1) Self-Monitoring, Analysis and Reporting Technology  
2) The write amplification factor (WAF) corresponds to the amount of data actually written to memory divided by the amount of data written by the host [WAF = Data written to flash memory ÷ Data written by host].



### 7.1.6.2.1.8 Custom boot logo

BIOS parameter	Setting options	Description
Custom boot logo	-	Displays whether a user-specific logo is being used
Add custom boot logo	Enter	Selects a customized boot logo A JPG graphic with a maximum size of 40 kB and filename "XPCLGO" must be used. The target file for the boot logo must be stored in folder "XPCLGO" in the root directory of the target media ( <i>.XPCLGO/XPCLGO.jpg</i> ).
Delete custom boot logo	Enter	Deletes customized boot logos <sup>1)</sup>

Table 84: Advanced - OEM Features - Custom boot logo

1) If no customized boot logo is available, the B&R boot logo is used by default.

### 7.1.6.2.1.9 Backup settings

BIOS parameter	Setting options	Description
Backup settings	<b>Disabled</b>	Disables/Enables backup of BIOS settings during the next reboot
	Enabled	Folder "XPCSET" ( <i>./XPCSET/</i> ) must exist in the root directory of the target medium as the target for the backup.
Recover settings	<b>Disabled</b>	Disables/Enables restoring BIOS settings from a backup during the next reboot
	Enabled	The backup file must be stored in folder "XPCSET" ( <i>./XPCSET/</i> ) in the root directory of the target medium.

Table 85: Advanced - OEM features - Backup settings

## 7.1.6.2.2 USB configuration

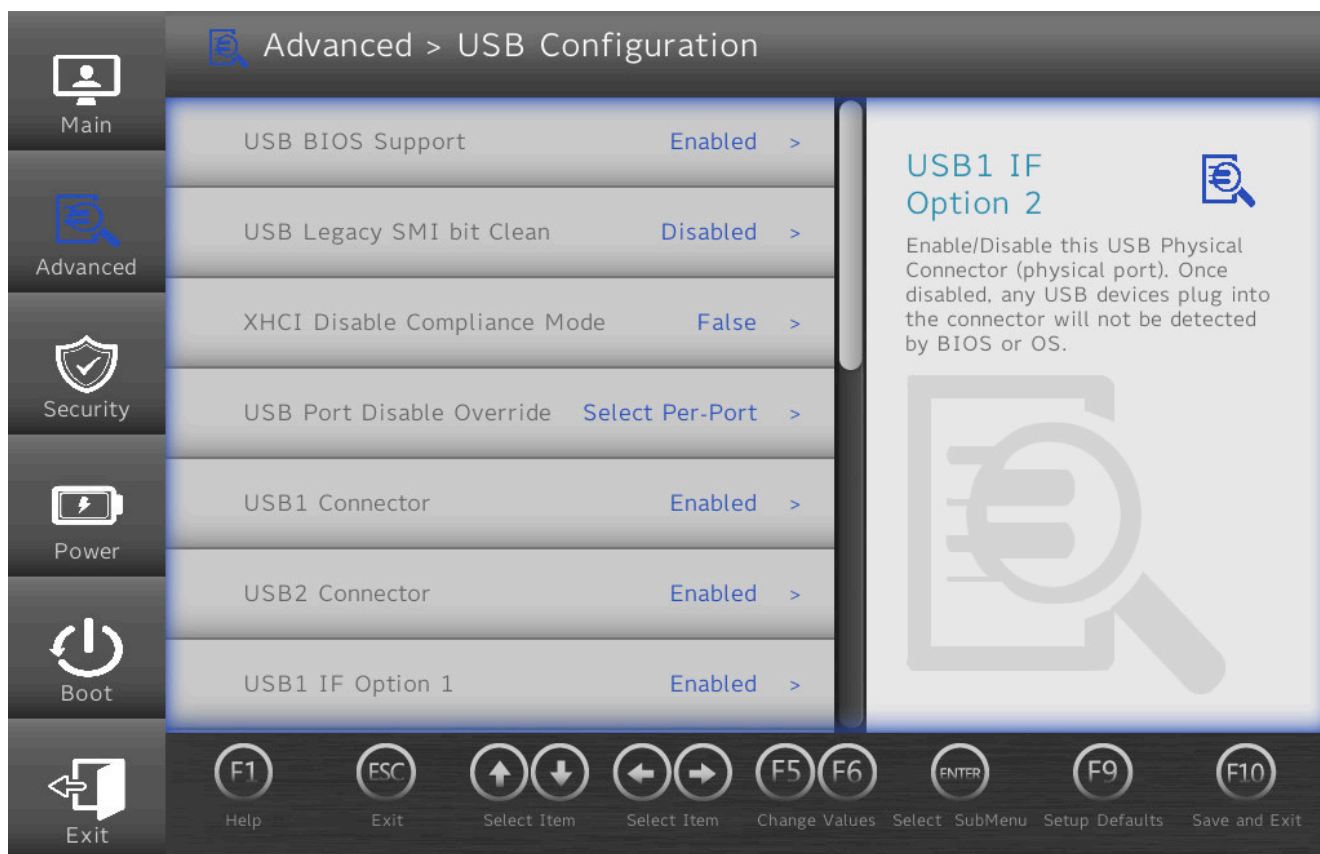

BIOS parameter	Setting options	Description
USB BIOS support	Disabled	Disables USB support in BIOS or enables USB support (UEFI only) or USB support (UEFI and Legacy Mode)
	<b>Enabled</b>	
	UEFI only	
USB legacy SMI bit clean	<b>Disabled</b>	Disables/Enables USB legacy SMI bit clean
	Enabled	
XHCI disable compliance mode	<b>False</b>	Selects XHCI disable compliance mode
	True	
USB port disable override <sup>1)</sup>	<b>Disabled</b>	Manually disables/enables USB ports (per port) or enables all ports
	Select per-port	
USB1 3.0 connector	Disabled	Disables/Enables the interface USB1 3.0 connector
	<b>Enabled</b>	
USB2 3.0 connector	Disabled	Disables/Enables the interface USB2 3.0 connector
	<b>Enabled</b>	
USB3 3.0 connector	Disabled	Disables/Enables the interface USB3 3.0 connector
	<b>Enabled</b>	
USB4 3.0 connector	Disabled	Disables/Enables the interface USB4 3.0 connector
	<b>Enabled</b>	
USB1 2.0 connector	Disabled	Disables/Enables the interface USB1 2.0 connector
	<b>Enabled</b>	
USB2 2.0 connector	Disabled	Disables/Enables the interface USB2 2.0 connector
	<b>Enabled</b>	
USB3 2.0 connector	Disabled	Disables/Enables the interface USB3 2.0 connector
	<b>Enabled</b>	
USB4 2.0 connector	Disabled	Disables/Enables the interface USB4 2.0 connector
	<b>Enabled</b>	
USB1 2.0 onboard panel	Disabled	Disables/Enables the interface USB1 2.0 onboard panel
	<b>Enabled</b>	
USB2 2.0 onboard panel	Disabled	Disables/Enables the interface USB2 2.0 onboard panel
	<b>Enabled</b>	
USB 2.0 SDL / DVI-D	Disabled	Disables/Enables the USB 2.0 interface on SDL / DVI-D
	<b>Enabled</b>	
USB 2.0 IF option	Disabled	Disables/Enables the USB 2.0 interface on the IF option
	<b>Enabled</b>	
USB 2.0 internal	Disabled	Disables/Enables the internal USB 2.0 interface
	<b>Enabled</b>	

Table 86: Advanced - OEM features - USB configuration

1) The names and scope of these parameters may vary depending on the main device and configuration.

## 7.1.6.2.3 Chipset configuration

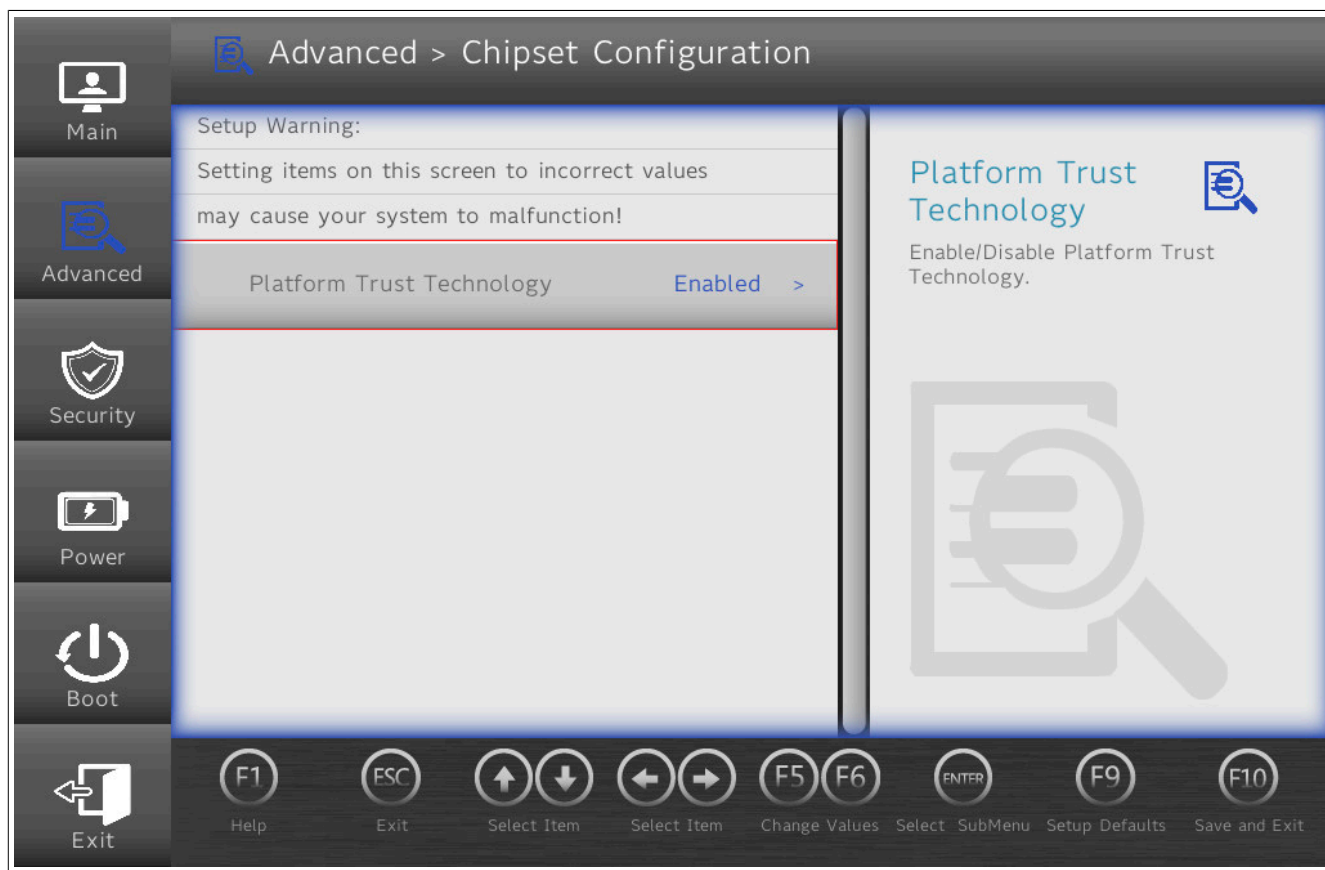
**Warning!**

Settings made in this screen can cause malfunctions if changes are made to configured TPM systems (e.g. Secure Boot).

BIOS parameter	Setting options	Description
Platform Trust Technology	Disabled	Disables/Enables Platform Trust Technology (PTT)
	<b>Enabled</b>	By default, firmware TPM (FTPM of the combination of CPU and PCH) is used. If PTT is disabled, the discrete TPM (hardware DTPM) is used.

Table 87: Advanced - Chipset configuration

### 7.1.6.2.4 ACPI table/features control

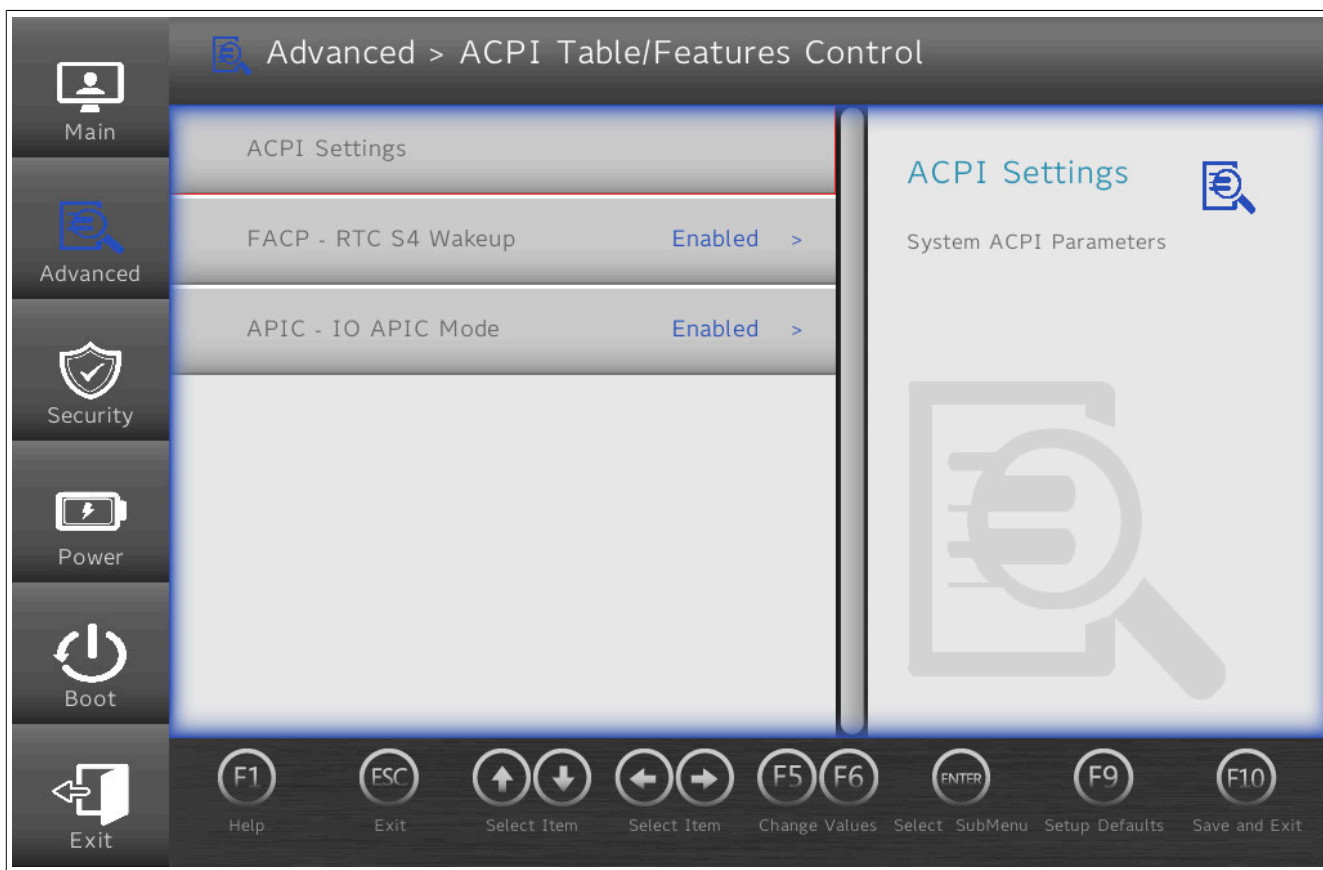

BIOS parameter	Setting options	Description
<b>ACPI settings</b>	Enter	Opens submenu "ACPI settings" on page 156
FACP - RTC S4 wakeup	Disabled <b>Enabled</b>	Disables/Enables S4 wakeup via RTC
APIC <sup>1)</sup> - IO APIC mode	Disabled <b>Enabled</b>	Disables/Enables IO APIC mode

Table 88: Advanced - OEM features - ACPI table/features control

1) Advanced Programmable Interrupt Controller

#### 7.1.6.2.4.1 ACPI settings

BIOS parameter	Setting options	Description
ACPI version	-	Displays the ACPI version
Enable ACPI auto configuration	Disabled <b>Enabled</b>	Disables/Enables ACPI BIOS auto-configuration
Enable hibernation	Disabled <b>Enabled</b>	Disables/Enables hibernation The effectiveness of this option may vary depending on the operating system.
PTID support	Disabled <b>Enabled</b>	Disables/Enable PTID support
PECI <sup>1)</sup> access method	<b>Direct I/O</b> ACPI	Selects the Peci access mode
ACPI S3 support	Disabled <b>Enabled</b>	Disables/Enable ACPI S3 support
Native PCIe enable	Disabled <b>Enabled</b>	Native operating system PCI Express support

Table 89: Advanced - OEM features - ACPI table/features control - ACPI settings

1) Platform environment control interface

## 7.1.6.2.5 CPU configuration

BIOS parameter	Setting options	Description
Type	-	Displays the CPU type
ID	-	Displays the CPU ID
Speed	-	Displays the CPU speed [MHz]
L1 data cache	-	Displays the L1 data cache [kB]
L1 instruction cache	-	Displays the L1 instruction cache [kB]
L2 cache	-	Displays the L2 cache [kB]
L3 cache	-	Displays the L3 cache [kB]
L4 cache	-	Displays the L4 cache [kB]
VMX	-	Displays VMX support
SMX/TXT	-	Displays SMX/TXT support
SW guard extension (SGX)	Disabled Enabled <b>Software controlled</b>	Disables/Enables software guard extension or lets it be determined by the system
Select owner EPOCH input type	<b>No change in owner EPOCH</b> Change to new random owner EPOCH Manual user defined owner EPOCH	Security key initial value <sup>1)</sup> unchanged, random or manual
CPU flex ratio override	<b>Disabled</b> Enabled	Disables/Enables the CPU flex ratio override
CPU flex ratio settings <sup>2)</sup>	INT Default: <b>24</b>	Defines the CPU flex ratio override multiplier Range: Hardware-dependent
Hardware prefetcher	<b>Disabled</b> Enabled	Disables/Enables the hardware prefetcher
Adjacent cache line prefetch	Disabled <b>Enabled</b>	Disables/Enables adjacent cache line prefetch
Intel (VMX) Virtualization Technology	Disabled <b>Enabled</b>	Disables/Enables Intel (VMX) Virtualization Technology
Active processor cores	<b>All</b> 1	Disables/Enables individual or all processor cores
Hyper threading	Disabled <b>Enabled</b>	Disables/Enables hyper-threading
BIST	<b>Disabled</b> Enabled	Disables/Enables the built-in self-test on reset
AES	Disabled <b>Enabled</b>	Disables/Enables the Advanced Encryption Standard
Machine check	Disabled <b>Enabled</b>	Disables/Enables the machine check

Table 90: Advanced - CPU configuration

- 1) For "initial value", see "seed" (key).  
2) This variable determines the multiplier for the CPU speed (variable \* 100 MHz = CPU frequency).  
The range of values is specified by the system and hardware.

## 7.1.6.2.6 Power &amp; Performance

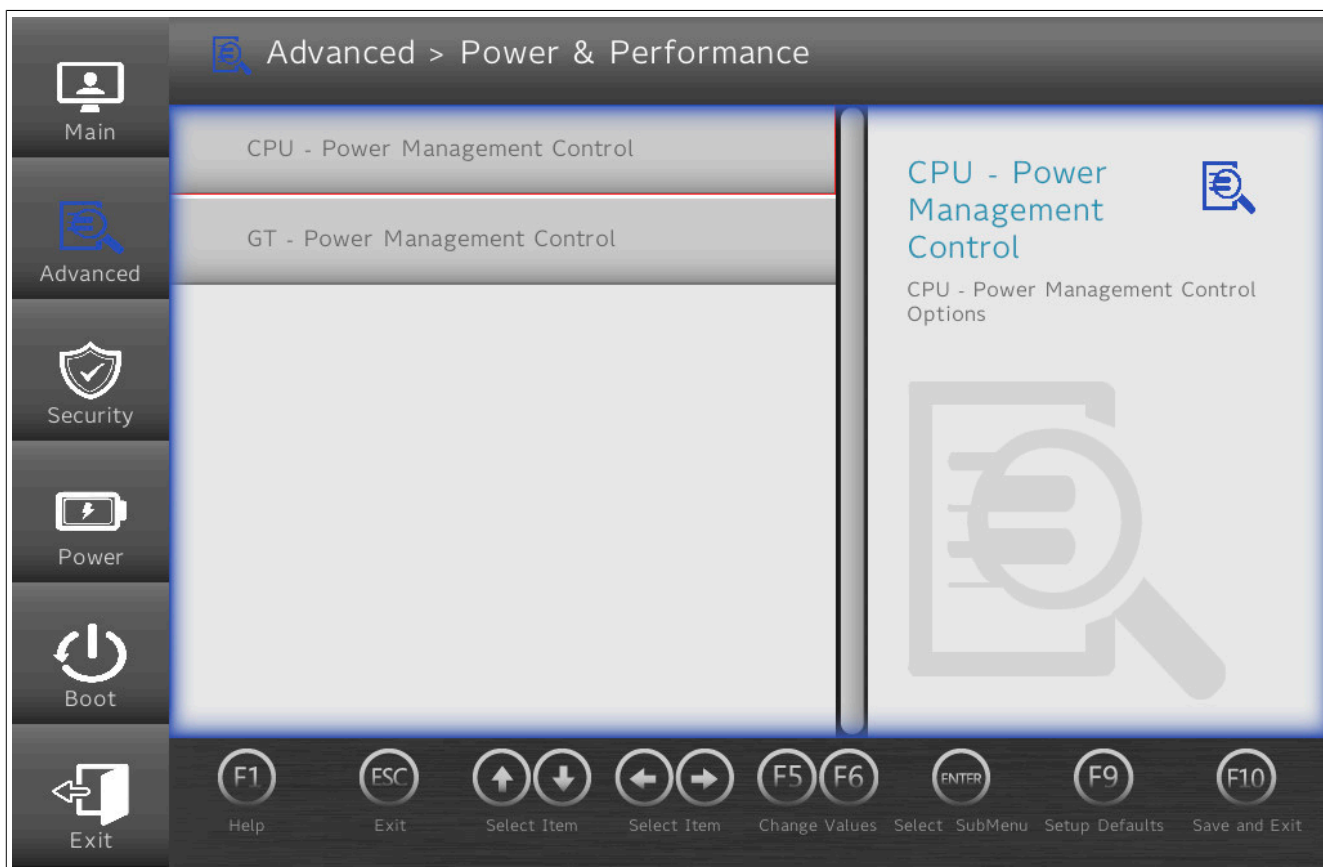

BIOS parameter	Setting options	Description
CPU - Power management control	Enter	Opens submenu "CPU - Power management control" on page 158
GT - Power management control	Enter	Opens submenu "GT - Power management control" on page 161

Table 91: Advanced - Power &amp; Performance

## 7.1.6.2.6.1 CPU - Power management control

BIOS parameter	Setting options	Description
Boot performance mode	<b>Max non-turbo performance</b>	Selects the performance mode in which BIOS starts
	Max battery	
	Turbo performance	
Intel® SpeedStep™	Disabled <b>Enabled</b>	Disables/Enables Intel SpeedStep for more than 2 supported frequency ranges
Race-to-halt (RTH)	<b>Disabled</b>	Disables/Enables race-to-halt
	Enabled	
Intel® Speed Shift Technology	<b>Disabled</b>	Disables/Enables Intel Speed Shift Technology <sup>1)</sup>
	Enabled	
HDC <sup>2)</sup> control	Disabled	Disables/Enables HDC control The processor can force system components into idle mode.
	<b>Enabled</b>	
Turbo mode	Disabled	Disables/Enables Intel Turbo Boost Technology Available only for processors with turbo mode support.
	<b>Enabled</b>	
View/Configure turbo options <sup>3)</sup>	Enter	Opens submenu "View/Configure turbo options" on page 160
Config TDP configurations	Enter	Opens submenu "Config TDP configurations" on page 160
Platform PL1 enable	<b>Disabled</b>	Disables/Enables platform power limit (PL1) programming Serves the processor as a performance limit in a specific time window.
	Enabled	
Platform PL1 power	INT Default: 0 <sup>3)</sup>	Defines the platform PL1 power limit [mW] <sup>4)</sup> Range: 0 to 4,095,875 Resolution: 1/8
Platform PL1 time window	INT Default: 0	Defines the platform PL1 time window [s] Range: 0 to 128
Platform PL2 enable	<b>Disabled</b>	Disables/Enables platform power limit (PL2) programming
	Enabled	
Platform PL2 power	INT Default: 0	Defines the platform PL2 power limit [mW] Range: 0 to 4,095,875 Resolution: 1/8

Table 92: Advanced - Power &amp; Performance - CPU power management control

BIOS parameter	Setting options	Description
Power limit 4 override	<b>Disabled</b>	Disables/Enables the power limit 4 override
	Enabled	Enable to set values for power limit 4 manually; otherwise, the system default values are used.
Power limit 4	INT Default: <b>0</b>	Defines PL4 power limit 4 [mW] Range: 0 to 4,095,875 Resolution: 1/8
Power limit 4 lock	<b>Disabled</b>	Disables/Enables the power limit 4 lock function
	Enabled	This can be used to lock the PL4 configuration when using an operating system.
C states <sup>6)</sup>	<b>Disabled</b>	Disables/Enables CPU C-states management
Thermal monitor	Disabled	Disables/Enables temperature monitoring
	<b>Enabled</b>	
<b>Power limit 3 settings</b>	Enter	Opens submenu "Power limit 3 settings" on page 161

Table 92: Advanced - Power &amp; Performance - CPU power management control

- 1) Intel Speed Shift Technology enables hardware-controlled P-states via the CPPC (Collaborative Processor Performance Control) v2 interface.
- 2) Hardware duty cycling
- 3) This submenu appears only if the Intel® Speed Shift Technology option is enabled.
- 4) For all power limits (PL1 to PL4), the additional description on the display unit must be observed. All values must be entered in mW.
- 5) The default value 0 for this table means that pre-programmed default values are used. The system does not use the numeric value 0.
- 6) The C-states options are described separately in the following table to maintain clarity.

BIOS setting	Configuration options	op-	Explanation
Enhanced C-states	Disabled		Disables/Enables enhanced C-states (C1E) The CPU switches to the lowest speed level if all cores are in a C-state.
	<b>Enabled</b>		
C-state auto demotion	C1		Selects or disables C-state auto-demotion Can be used to prevent unnecessary changing of C-states.
	<b>C1 and C3</b>		
	C3		
	Disabled		
C-state un-demotion	C1		Selects or disables C-state un-demotion
	<b>C1 and C3</b>		
	C3		
	Disabled		
Package C-state demotion	<b>Auto</b>		Disables/Enables package C-state demotion or sets it automatically
	Disabled		
	Enabled		
Package C-state un-demotion	<b>Auto</b>		Disables/Enables package C-state un-demotion or sets it automatically
	Disabled		
	Enabled		
CState pre-wake	Disabled		Disables/Enables CState pre-wake
IO MWAIT redirection	<b>Disabled</b>		Disables/Enables I/O MWAIT redirection
	Enabled		
Package C-state limit	<b>Auto</b>		Selects package C-state limits, sets it automatically (lowest available state selected) or the CPU default (default C-state of the CPU)
	CPU default		
	C10		
	C9		
	C8		
	C7S		
	C7		
	C6		
	C3		
	C2		
	C0/C1		
C3 latency control (MSR 0x60A)			
Time unit	1 ns		Select the IRTL <sup>2)</sup> time unit [ns]
	32 ns		
	<b>1024 ns</b>		
	32768 ns		
	1048576 ns		
	33554432 ns		
Latency	INT Default: <b>78</b>		Defines the IRTL value Range: 0 to 1023
C6/C7 short latency control (MSR 0x60B)			
Time unit	1 ns		Selects the IRTL time unit [ns]
	32 ns		
	<b>1024 ns</b>		
	32768 ns		
	1048576 ns		
	33554432 ns		
Latency	INT Default: <b>118</b>		Defines the IRTL value Range: 0 to 1023

Table 93: Advanced - Power &amp; Performance - CPU power management control - C-states

## Software

BIOS setting	Configurations	op-	Explanation
C6/C7 long latency control (MSR 0x60C)			
Time unit	1 ns		Selects the IRTL time unit [ns]
	32 ns		
	<b>1024 ns</b>		
	32768 ns		
	1048576 ns		
	33554432 ns		
Latency	INT Default: <b>148</b>		Defines the IRTL value Range: 0 to 1023
C8 latency control (MSR 0x633)			
Time unit	1 ns		Selects the IRTL time unit [ns]
	32 ns		
	<b>1024 ns</b>		
	32768 ns		
	1048576 ns		
	33554432 ns		
Latency	INT Default: <b>250</b>		Defines the IRTL value Range: 0 to 1023
C9 latency control (MSR 0x634)			
Time unit	1 ns		Selects the IRTL time unit [ns]
	32 ns		
	<b>1024 ns</b>		
	32768 ns		
	1048576 ns		
	33554432 ns		
Latency	INT Default: <b>332</b>		Defines the IRTL value Range: 0 to 1023
C10 latency control (MSR 0x635)			
Time unit	1 ns		Selects the IRTL time unit [ns]
	32 ns		
	<b>1024 ns</b>		
	32768 ns		
	1048576 ns		
	33554432 ns		
Latency	INT Default: <b>1010</b>		Defines the IRTL value Range: 0 to 1023

Table 93: Advanced - Power & Performance - CPU power management control - C-states

- 1) Voltage regulator (module)
- 2) Interrupt response time limit

### View/Configure turbo options

BIOS parameter	Setting options	Description
Max turbo power limit	-	Displays the max. turbo power limit
Min turbo power limit	-	Displays the min. turbo power limit
Package TDP limit	-	Displays the package TDP limit
Power limit 1	-	Displays power limit 1
Power limit 2	-	Displays power limit 2
1-core turbo ratio	-	Displays the 1-core turbo ratio
2-core turbo ratio	-	Displays the 2-core turbo ratio
Energy efficient P-state	Disabled	Disables/Enables energy-efficient P-states
	<b>Enabled</b>	
Package power limit MSR lock	<b>Disabled</b> Enabled	Disables/Enables the package power limit MSR lock function A reset is necessary to unlock the register.
1-core ratio limit override	INT Default: <b>24</b>	Defines the frequency of CPU turbo on an active core Range: 1 to 255
2-core ratio limit override	INT Default: <b>24</b>	Defines the frequency of CPU turbo on two active cores Range: 1 to 255
Energy efficient turbo	Disabled	Disables/Enables energy-efficient turbo Reduces the turbo frequency to increase energy efficiency.
	<b>Enabled</b>	

Table 94: Advanced - Power & Performance - CPU power management control - View/Configure turbo options

### Config TDP configurations

BIOS parameter	Setting options	Description
Configurable TDP <sup>1)</sup> boot mode	Deactivate	Selects the configurable TDP boot mode
	Down	Nominal: TDP is not overshoot or undershot.
	<b>Nominal</b>	Down: TDP is undershot and the processor works with lower power.
Configurable TDP lock	<b>Disabled</b>	Disables/Enables TDP control register
	Enabled	

Table 95: Advanced - Power & Performance - CPU power management control - Config TDP configurations



BIOS parameter	Setting options	Description
CTDP BIOS control	<b>Disabled</b>	Disables/Enables CTDPS BIOS control
	Enabled	
ConfigTDP levels	-	Displays the ConfigTDP levels supported by the MSR <sup>2)</sup>
ConfigTDP turbo activation ratio	-	Displays the ConfigTDP turbo activation ratio values read by the MSR
Power limit 1	-	Displays the PL1 values from MMIO <sup>3)</sup>
Power limit 2	-	Displays the PL2 values from MMIO
Custom settings nominal		
ConfigTDP nominal	-	Displays the ConfigTDP nominal ratio, turbo activation ratio and PL1 read from the MSR
Power limit 1 <sup>4)</sup>	INT Default: <b>0</b> <sup>5)</sup>	Defines the PL1 power limit [mW] Range: 0 to 4,095,875 Resolution: 125 mW
Power limit 2	INT Default: <b>0</b>	Defines the PL2 power limit [mW] Range: 0 to 4,095,875 Resolution: 125 mW
Power limit 1 time window	INT Default: <b>0</b>	Defines the PL1 time window [s] Range: 0 to 128
ConfigTDP turbo activation ratio	INT Default: <b>0</b>	Defines the ConfigTDP turbo activation ratio Range: 0 to 255
Custom settings down		
ConfigTDP level1	-	Displays the ConfigTDP nominal ratio, turbo activation ratio and PL1 read from the MSR
Power limit 1	INT Default: <b>0</b>	Defines the PL1 power limit [mW] Range: 0 to 4,095,875 Resolution: 125 mW
Power limit 2	INT Default: <b>0</b>	Defines the PL2 power limit [mW] Range: 0 to 4,095,875 Resolution: 125 mW
Power limit 1 time window	INT Default: <b>0</b>	Defines the PL1 time window [s] Range: 0 to 128
Config TDP turbo activation ratio	INT Default: <b>0</b>	Defines the ConfigTDP turbo activation ratio Range: 0 to 255

Table 95: Advanced - Power &amp; Performance - CPU power management control - Config TDP configurations

- 1) Thermal design power
- 2) Model-specific register
- 3) Memory-mapped I/O
- 4) For all power limits (PL1 to PL2), the additional description on the display unit must be observed. All values must be entered in mW.
- 5) The default value 0 for this table means that pre-programmed default values are used. The system does not use the numeric value 0.

### Power limit 3 settings

BIOS parameter	Setting options	Description
Power limit 3 override	<b>Disabled</b>	Disables/Enables power limit 3 If the power limit 3 override is disabled, default values are used.
	Enabled	
Power limit 3 <sup>1)</sup>	INT Default: <b>0</b> <sup>2)</sup>	Defines power limit 3 [mW] Range: 0 to 4,095,875 Resolution: 125 mW
Power limit 3 time window	INT Default: <b>0</b>	Selects the power limit 3 time window [s] Range: 0 to 64
Power limit 3 duty cycle	INT Default: <b>0</b>	Defines the power limit 3 duty cycle [%] Range: 0 to 100 Resolution: 1
Power limit 3 lock	Disabled	Disables/Enables the power limit 3 lock function
	<b>Enabled</b>	

Table 96: Advanced - Power &amp; Performance - CPU power management control - Power limit 3 settings

- 1) The additional description on the display unit must be observed.
- 2) The default value 0 for this table means that pre-programmed default values are used. The system does not use the numeric value 0.

### 7.1.6.2.6.2 GT - Power management control

BIOS parameter	Setting options	Description
RC6 (render standby)	Disabled	Disable/Enables RC6 (render standby) Permits the GPU to go into standby.
	<b>Enabled</b>	
Maximum GT frequency	<b>Default max frequency</b>	Maximum graphics frequency (including graphic turbo) [MHz] The max. possible frequency is selected by default. Resolution: 50 MHz
	100 to 1200 Mhz	

Table 97: Advanced - Power &amp; Performance - GT power management control

## 7.1.6.2.7 Memory configuration

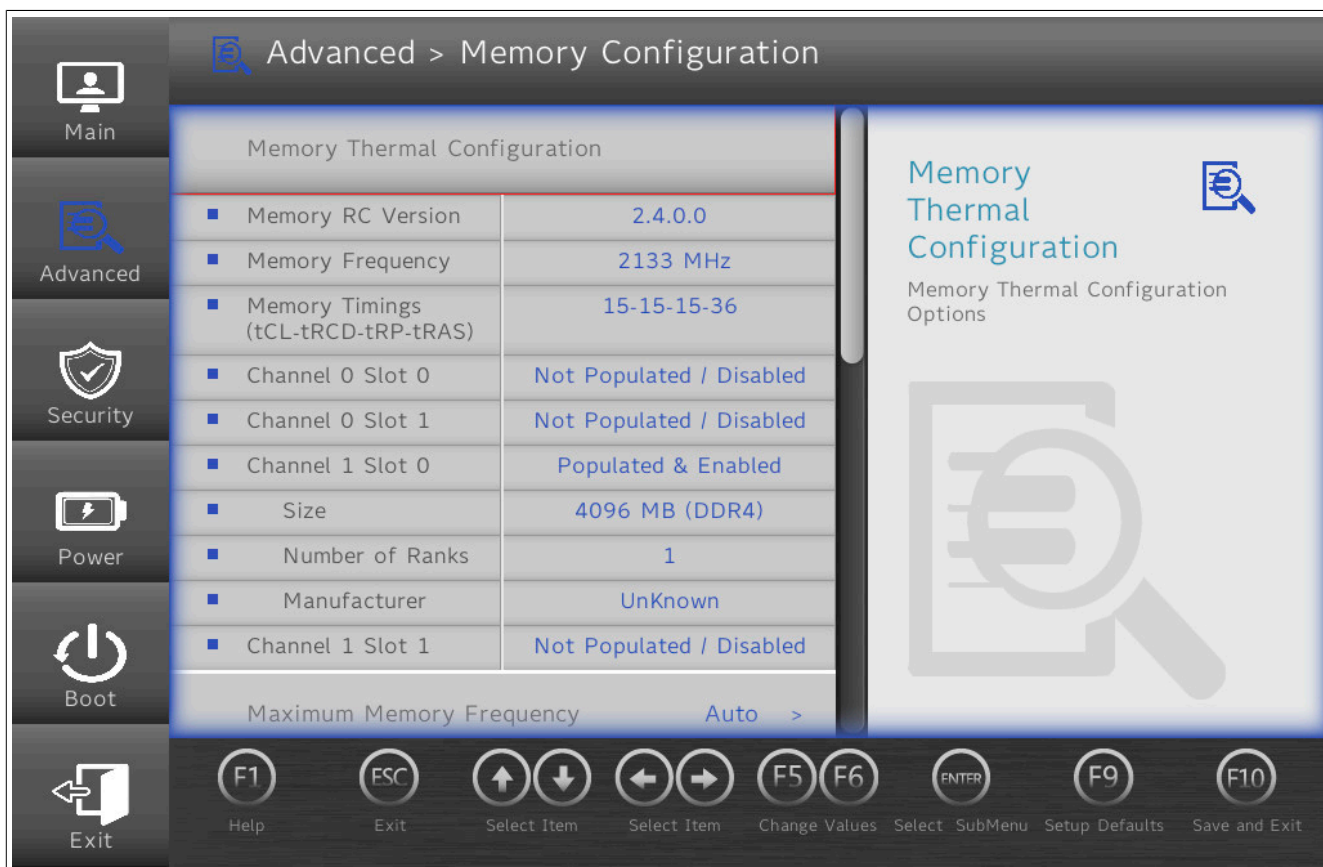

BIOS parameter	Setting options	Description
<b>Memory thermal configuration</b>	Enter	Opens submenu "Memory thermal configuration" on page 163
Memory RC version	-	Displays the memory RC version
Memory frequency	-	Displays the memory frequency [MHz]
Memory timings	-	Displays RAM timing
Channel 0 slot 0	-	Displays the memory status
Size	-	Displays the memory size [MB]
Number of ranks	-	Displays the number of ranks
Manufacturer	-	Displays the memory manufacturer
Channel 0 slot 1	-	Displays the memory status
Size	-	Displays the memory size [MB]
Number of ranks	-	Displays the number of ranks
Manufacturer	-	Displays the memory manufacturer
Channel 1 slot 0	-	Displays the memory status
Size	-	Displays the memory size [MB]
Number of ranks	-	Displays the number of ranks
Manufacturer	-	Displays the memory manufacturer
Channel 1 slot 1	-	Displays the memory status
Size	-	Displays the memory size [MB]
Number of ranks	-	Displays the number of ranks
Manufacturer	-	Displays the memory manufacturer
Memory maximum frequency	<b>Auto</b> (Various)	Selects the maximum frequency of RAM [MHz] automatically or manually
Max TOLUD <sup>1)</sup>	<b>Dynamic</b> (Various)	Sets the max. TOLUD [GB] automatically (dynamic) or manually Resolution: 0.25 GB
Retain on fast fail	Disabled <b>Enabled</b>	Disables/Enables retain on fast fail If this parameter is enabled, a cold reboot is performed after a failed software memory test.
Exit on failure (MRC <sup>2)</sup> )	Disabled <b>Enabled</b>	Disables/Enables exit on failure (MRC) Enabling makes it possible to exit on failure for MRC training.
Channel A DIMM control	Disable both DIMMs Disable DIMM0 Disable DIMM1 <b>Enable both DIMMs</b>	Selects the mode of main memory channel A control Disables/Enables both or individual DIMMs
Channel B DIMM control	Disable both DIMMs Disable DIMM0 Disable DIMM1 <b>Enable both DIMMs</b>	Selects the mode of main memory channel B control Disables/Enables both or individual DIMMs

Table 98: Advanced - Memory configuration

BIOS parameter	Setting options	Description
Force single rank	<b>Disabled</b>	Disables/Enables force single rank
	Enabled	
Memory remap	Disabled	Disables/Enables memory remapping (available starting at 4 GB RAM)
	<b>Enabled</b>	
Mrc fast boot	Disabled	Disables/Enables MRC fast boot
	<b>Enabled</b>	

Table 98: Advanced - Memory configuration

- 1) Top of low usable DRAM
- 2) Memory reference code

### 7.1.6.2.7.1 Memory thermal configuration

BIOS parameter	Setting options	Explanation
Memory power and thermal throttling	Enter	Opens submenu "Memory power and thermal throttling" on page 163
Memory thermal management	<b>Disabled</b>	Disables/Enables memory thermal management
	Enabled	
PECI inject temperature	<b>Disabled</b>	Disables Peci injected temperature or transfers the RAM temperature to the processor via Peci
	Enabled	
EXTTS# via TS <sup>1)</sup> -on-board	<b>Disabled</b>	Disables/Enables routing of the TS-on-board pins to PCH (ALERT# via EXTTS#)
	Enabled	
EXTTS# via TS-on-DIMM	<b>Disabled</b>	Disables/Enables routing of the TS-on-DIMM pins to PCH (ALERT# via EXTTS#)
	Enabled	
Virtual temperature sensor (VTS)	<b>Disabled</b>	Disables/Enables the virtual temperature sensor
	Enabled	

Table 99: Advanced - Memory configuration - Memory thermal configuration

- 1) Thermal sensor

### Memory power and thermal throttling

BIOS parameter	Setting options	Description
REFRESH_2X_MODE	<b>Disabled</b>	Disables REFRESH_2X_MODE or selects the mode The IMC <sup>1)</sup> enables refresh with 2x interval only at high temperature or at increased and high temperature.
	1- Enabled for WARM or HOT	
	2- Enabled for HOT only	
SelfRefresh enable	Disabled	Disables/Enables SelfRefresh
	<b>Enabled</b>	
SelfRefresh IdleTimer	INT Default: <b>512</b>	Defines the SelfRefresh IdleTimer in DLCK800s Range: 0 to 65535

Table 100: Advanced - Memory configuration - Memory thermal configuration - Memory power and thermal throttling

- 1) Integrated memory controller

## 7.1.6.2.8 System agent (SA) configuration

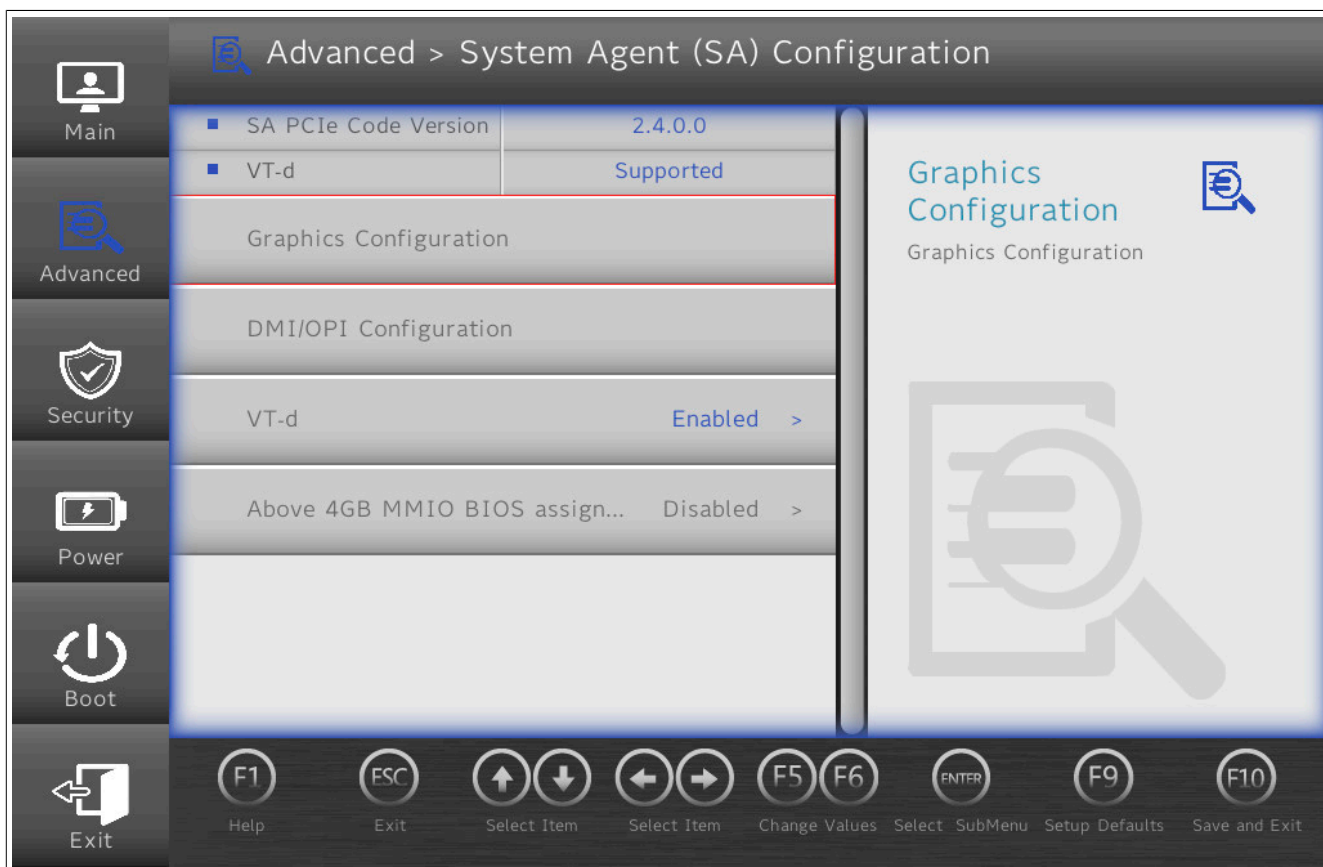

BIOS parameter	Setting options	Description
SA PCIe code version	-	Displays the SA PCIe code version
VT-d <sup>1)</sup>	-	Displays VT-d support
<b>Graphics configuration</b>	Enter	Opens submenu "Graphics configuration" on page 164
<b>DMI<sup>2)</sup>/OPI<sup>3)</sup> configuration</b>	Enter	Opens submenu "DMI/OPI configuration" on page 165
VT-d	Disabled	Disables/Enables VT-d
	<b>Enabled</b>	
Above 4 GB MMIO BIOS assignment	<b>Disabled</b>	Disables/Enables above 4 GB MMIO BIOS assignment
	Enabled	

Table 101: Advanced - System agent (SA) configuration

- 1) Intel Virtualization Technology for Directed I/O
- 2) Direct Media Interface
- 3) On package DMI interconnect Interface

## 7.1.6.2.8.1 Graphics configuration

BIOS parameter	Setting options	Description
Graphics turbo IMON current	INT Default: <b>31</b>	Defines the graphics turbo IMON current Range: 14 to 31
GTT <sup>1)</sup> size	<b>8 MB</b>	Selects the GTT size [MB]
	4 MB	
	2 MB	
Aperture size	128 MB	Selects reserved RAM [MB] If the graphics memory is full, the defined amount of memory is made available.
	<b>256 MB</b>	
	512 MB	
	1024 MB	
DVMT <sup>2)</sup> pre-allocated	4M to 64M Default: <b>32M</b>	Defines the allocated graphics memory (DVMT) [MB] to be used by the IGD <sup>3)</sup> .
DVMT total Gfx mem	<b>256M</b>	Selects the memory size [MB] that can be used by the IDG. MAX uses the entire available main memory. The additional memory is dynamically allocated according to DVMT 5.0.
	128M	
	MAX	
Gfx low power mode <sup>4)</sup>	Disabled	Disables/Enables the graphic controller's sleep mode
	<b>Enabled</b>	
VDD enable	Disabled	Disables/Enables force VDD
	<b>Enabled</b>	
HDCP support	Disabled	Disables/Enable HDCP support
	<b>Enabled</b>	

Table 102: Advanced - System agent (SA) configuration - Graphics configuration

BIOS parameter	Setting options	Description
Algorithm	<b>One-time</b>	Selects HDCP re-encryption flow
	Periodic	
PM support	Disabled	Disables/Enables power management support
	<b>Enabled</b>	
PAVP enable	Disabled	Disables/Enables "Force protected audio video path"
	<b>Enabled</b>	
Cdynmax clamping enable	Disabled	Disables/Enables Cdynmax clamping
	<b>Enabled</b>	
Cd clock frequency	337.5 Mhz	Select highest supported Cd clock frequency [MHz]
	450 Mhz	
	540 Mhz	
	<b>675 Mhz</b>	
<b>LCD control</b>	Enter	Opens submenu " <a href="#">LCD control</a> " on page 165

Table 102: Advanced - System agent (SA) configuration - Graphics configuration

- 1) Graphics translation table (see also graphics aperture/address remapping table (GART))
- 2) Dynamic video memory technology
- 3) Internal graphics device
- 4) This function is only available for small form factor devices.

### LCD control

BIOS parameter	Setting options	Description
Primary display	-	Displays the primary display
Secondary display	-	Displays the secondary display
<b>Primary display priority</b>	Enter	Opens submenu " <a href="#">Primary display priority</a> " on page 165
<b>Secondary display priority</b>	Enter	Opens submenu " <a href="#">Secondary display priority</a> " on page 165
Panel scaling	<b>Auto</b>	Disables, forces or selects panel scaling automatically
	Force scaling	
	Off	

Table 103: Advanced - System agent (SA) configuration - Graphics configuration - LCD control

### Primary display priority

BIOS parameter	Setting options	Description
1st device	<b>Onboard panel</b>	Selects the device with the highest priority
	IF option	
	SDL / DVI-D	
2nd device	Onboard panel	Selects the device with the medium priority
	<b>IF option</b>	
	SDL / DVI-D	
3rd device	Onboard panel	Selects the device with the lowest priority
	IF option	
	<b>SDL / DVI-D</b>	

Table 104: Advanced - System agent (SA) configuration - Graphics configuration - LCD control - Primary display priority

### Secondary display priority

BIOS parameter	Setting options	Description
1st device	<b>Onboard panel</b>	Selects the device with the highest priority or disables the priority list for the secondary display
	IF option	
	SDL / DVI-D	
	Disabled	
2nd device	Onboard panel	Selects the device with the medium priority
	<b>IF option</b>	
	SDL / DVI-D	
3rd device	Onboard panel	Selects the device with the lowest priority
	IF option	
	<b>SDL / DVI-D</b>	

Table 105: Advanced - System agent (SA) configuration - Graphics configuration - LCD control - Secondary display priority

### 7.1.6.2.8.2 DMI/OPI configuration

BIOS parameter	Setting options	Description
DMI Vc1 control	<b>Disabled</b>	Disables/Enables DMI Vc1
	Enabled	
DMI Vcm control	Disabled	Disables/Enables DMI Vcm
	<b>Enabled</b>	

Table 106: Advanced - System agent (SA) configuration - DMI/OPI configuration

## 7.1.6.2.9 PCH-IO configuration

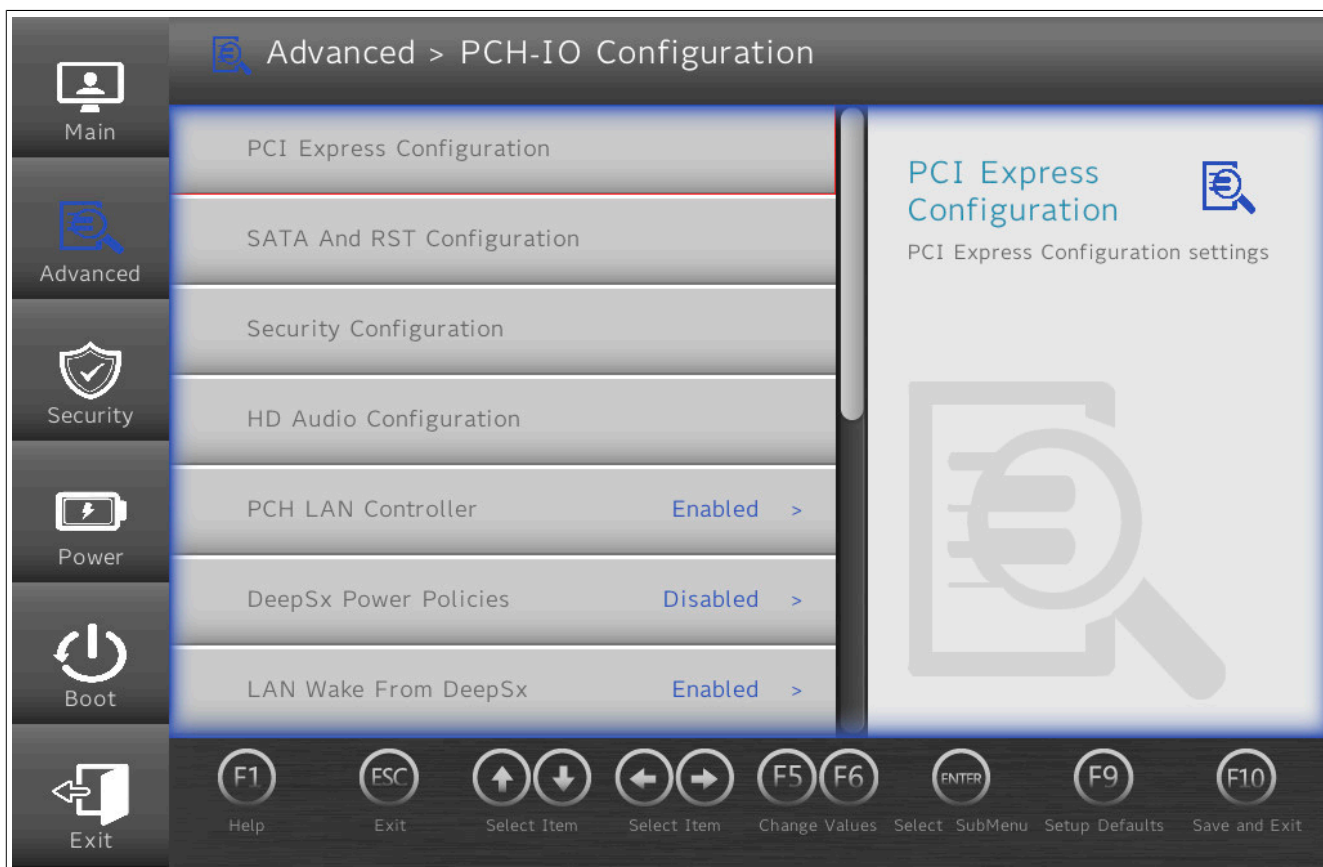

BIOS parameter	Setting options	Description	
PCI Express configuration	Enter	Opens submenu "PCI Express configuration" on page 167	
SATA and RST configuration	Enter	Opens submenu "SATA and RST configuration" on page 169	
Security configuration	Enter	Opens submenu "Security configuration" on page 170	
HD audio configuration	Enter	Opens submenu "HD audio configuration" on page 170	
PCH LAN controller	Disabled <b>Enabled</b>	Disables/Enables PCH LAN controller	
DeepSx power policies	<b>Disabled</b> Enabled in S4-S5	Disables/Enables DeepSx power policies	
LAN wake from DeepSx	Disabled <b>Enabled</b>	Disables/Enables LAN wake from DeepSx	
	Wake on LAN enabled	Disabled <b>Enabled</b>	Disables/Enables wake on LAN enable
	SLP_LAN# low on DC power	Disabled <b>Enabled</b>	Disables/Enables SLP_LAN# low on DC power
Port 61h bit-4 emulation	Disabled <b>Enabled</b>	Disables/Enables port 61h bit-4 emulation	
State after G3	S0 state <b>S5 state</b>	Working Soft off	Selects the state after G3 Defines how to proceed after "mechanical off" (G3). S0 or S5 after G3
Numlock	<b>Off</b> On	Disables/Enables the numeric keypad during booting Enables BIOS input via the numeric keypad of a keyboard.	
Screenshot function	<b>Disabled</b> Enabled	Disables/Enables the screenshot function This function is only available in BIOS and cannot be used in operating systems. Screenshots are stored in BMP format and named using the capture time (yyyymmddhhmmss).	
Shell startup script delay	INT Default: <b>3</b>	Defines the shell startup script delay time [s] Range: 0 to 10	
Block boot fail pop-up	<b>Disabled</b> Enabled	Enables/Disables the boot-fail pop-up (e.g. for UEFI PXE). The device tries to boot automatically from the next boot device after a boot failure.	

Table 107: Advanced - PCH-IO configuration

### 7.1.6.2.9.1 PCI Express configuration

BIOS parameter	Setting options	Description
PCI Express clock gating	Disabled	Disables/Enables PCI Express clock gating for root ports
	<b>Enabled</b>	
Legacy IO low latency	<b>Disabled</b>	Disables/Enables legacy I/O low latency
	Enabled	
DMI link ASPM control	Disabled	Disables/Enables DMI link ASPM control
	<b>Enabled</b>	
PCIe port assigned to LAN	-	Displays the PCIe port assigned to the LAN
Port8xh decode	<b>Disabled</b>	Disables/Enables Port8xh decoding
	Enabled	
Peer memory write enable	<b>Disabled</b>	Disables/Enables peer memory write enable
	Enabled	
Compliance test mode	<b>Disabled</b>	Disables/Enables compliance test mode
	Enabled	
PCIe USB glitch W/A <sup>1)</sup>	<b>Disabled</b>	Disables/Enables PCIe USB glitch W/A For faulty USB devices after the PCIe/PEG <sup>2)</sup> port
	Enabled	
PCIe function swap	Disabled	Disables/Enables PCIe function swap
	<b>Enabled</b>	
<b>PCI Express Gen3 eq lanes</b>	Enter	Opens submenu "PCI Express Gen3 eq lanes" on page 167
<b>PCI Express root port n<sup>3)</sup></b>	Enter	Opens submenu "PCI Express root port n" on page 167

Table 108: Advanced - PCH-IO configuration - PCI Express configuration

- 1) PCIe-USB glitch workaround
- 2) PCIe for graphics
- 3) Depending on the hardware, all available PCIe root ports are listed.

#### PCI Express Gen3 eq lanes

BIOS parameter	Setting options	Description
PCIEn <sup>1)</sup> Cm	INT Default: <b>6</b>	Defines PCIe <i>n</i> Cm Range: 0 to 63
PCIEn <sup>1)</sup> Cp	INT Default: <b>2</b>	Defines PCIe <i>n</i> Cp Range: 0 to 63
Override SW EQ setting	<b>Disabled</b>	Disables/Enables SW EQ setting override
	Enabled	
Coeffq <sup>2)</sup> Cp	INT Default: (Diverse)	Defines <i>q</i> Cp Range: 0 to 63
Coeffq <sup>2)</sup> Cm	INT Default: <b>2</b>	Defines <i>q</i> Cm Range: 0 to 63

Table 109: Advanced - PCH-IO configuration - PCI Express configuration - PCI Express Gen3 Eq Lanes

- 1) *n* is the number of available PCIe root ports.
- 2) *q* ranges from 0 to 5.

#### PCI Express root port *n*

BIOS parameter	Setting options	Description
PCI Express root port <i>n</i> <sup>1)</sup>	Disabled	Disables/Enables PCI Express root port <i>n</i>
	<b>Enabled</b>	
Topology	x4	Selects the PCIe root port topology
	Unknown	
	x1	
	SATA Express	
	M2	
ASPM	<b>Auto</b>	Selects PCIe Active State Power Management manually/automatically or disables it
	Disabled	
	L0sL1	
	L0s	
	L1	
L1 substates	Disabled	Selects or disables L1 substates
	L1.1	
	L1.2	
	<b>L1.1 &amp; L1.2</b>	
Gen3 Eq Phase3 Method	Hardware	PCIe Gen3 equalization Phase3 method
	<b>Software search</b>	
	Static coeff.	
UPTP <sup>2)</sup>	INT Default: <b>5</b>	Selects the UPT preset Range: 0 to 10
DPTP <sup>3)</sup>	INT Default: <b>7</b>	Selects the DPT preset Range: 0 to 10
ACS <sup>4)</sup>	Disabled	Disables/Enables access control services extended capabilities
	<b>Enabled</b>	

Table 110: Advanced - PCH-IO configuration - PCI Express root port *n*

BIOS parameter		Setting options	Description	
	URR	<b>Disabled</b>	Disables/Enables unsupported request reporting	
		Enabled	Notification of unsupported requests.	
	FER	<b>Disabled</b>	Disables/Enables fatal error reporting	
		Enabled	Notification of fatal errors <sup>5)</sup>	
	NFER	<b>Disabled</b>	Disables/Enables non-fatal error reporting	
		Enabled	Notification of non-fatal errors <sup>5)</sup>	
	CER	<b>Disabled</b>	Disable/Enable correctable error reporting	
		Enabled	Notification of correctable errors <sup>5)</sup>	
	CTO	<b>Disabled</b>	Disables/Enables PCIe completion timer timeout	
		Enabled		
	SEFE	<b>Disabled</b>	Disables/Enables system error on fatal error <sup>6)</sup>	
		Enabled		
SENEFE	<b>Disabled</b>	Disables/Enables system error on non-fatal error <sup>6)</sup>		
	Enabled			
SECE	<b>Disabled</b>	Disables/Enables system error on correctable error <sup>6)</sup>		
	Enabled			
PME SCI	Disabled	Disables/Enables system control interrupt on a power management event		
Hot plug	<b>Disabled</b>	Disables/Enables hot plugging		
	Enabled			
Advanced error reporting	Disabled	Disables/Enables advanced error reporting		
	<b>Enabled</b>			
PCIe speed		<b>Auto</b>	Selects the PCIe transfer rate [gigatransfers per second (GT/s)] automatically or manually	
		Gen1	Gen1: Max. 2.5 GT/s	
		Gen2	Gen2: Max. 5.0 GT/s	
		Gen3	Gen3: Max. 8.0 GT/s	
	Transmitter half swing	<b>Disabled</b>	Disables/Enables transmitter half-swing	
		Enabled	Signals are transferred with a half-swing.	
Detect timeout		INT Default: <b>0</b>	Defines the detect timeout [ms] If no link is received from an enabled port after the detect timeout has expired, it is assumed that no device is present there. The system can disable the port if necessary. Range: 0 to 65535	
Extra bus reserved		INT Default: <b>0</b>	Defines the extra bus reserved for bridges after this root bridge Range: 0 to 7	
Reserved memory		INT Default: <b>10</b>	Defines reserved memory [MB] for this bridge Range: 0 to 20	
Reserved I/O		INT Default: <b>4</b>	Defines the reserved I/O range for this bridge Range: 4 to 20 kB Resolution: 4 kB	
PCH PCIe LTR configuration				
PCH PCIE1 LTR		Disabled <b>Enabled</b>	Disables/Enables PCIe latency reporting	
	Snoop latency override	<b>Auto</b>	Disables the snoop latency override or selects manual or automatic mode	
		Disabled		
		Manual		
	Snoop latency value	INT Default: <b>60</b>	Defines the snoop latency value Range: 0 to 1023	
		Snoop latency multiplier		1 ns
				32 ns
				<b>1024 ns</b>
				32768 ns
1048576 ns				
	Non-snoop latency value	1 ns	Defines the non-snoop latency value Range: 0 to 1023	
		32 ns		
		<b>1024 ns</b>		
		32768 ns		
		1048576 ns		
	Non-snoop latency multiplier	1 ns	Defines the non-snoop latency multiplier value [ns]	
		32 ns		
		<b>1024 ns</b>		
		32768 ns		
		1048576 ns		
	Force LTR override	<b>Disabled</b>	Disables/Enables force LTR override	
		Enabled		
		<b>Enabled</b>		
PCIE1 LTR lock		<b>Disabled</b> Enabled	Disables/Enables the PCIE1 LTR lock function	
PCH PCIe CLKREQ#		<b>Disabled</b> Enabled		

Table 110: Advanced - PCH-IO configuration - PCI Express root port *n*



BIOS parameter	Setting options	Description
PCH PCIe CLKREQ# mapping override	Custom number	Disables the clock request number for standard platform mapping or uses the default values or manual value
	<b>Default</b>	
	No CLKREQ	
CLKREQ number	INT Default: <b>0</b>	Defines the CLKREQ number Range: 0 to 15

Table 110: Advanced - PCH-IO configuration - PCI Express root port *n*

- 1) PCI Express root port *n* must be enabled in order to make further configurations.
- 2) Upstream port transmitter preset  
The default value is system-optimized by B&R.
- 3) Downstream port transmitter preset  
The default value is system-optimized by B&R.
- 4) Changes to the ACS have no effect on the display of the following indented parameters.
- 5) With a multifunction device, all functions within the device are monitored.  
For the root port, the error occurs within the root complex.
- 6) Generates a system error if an error of this category is reported by a root port or device on a root port.

### 7.1.6.2.9.2 SATA and RST configuration

BIOS parameter	Setting options	Description
SATA controller(s) <sup>1)</sup>	Disabled <b>Enabled</b>	Disables/Enables the SATA controller
SATA mode selection	<b>AHCI</b> Intel RST premium with Intel Optane	Select SATA mode AHCI (not RAID) or Optane (or RAID) See " <a href="#">RAID configuration</a> " on page 183.
SATA test mode	<b>Disabled</b> Enabled	Disables/Enables the test function This is only used for control measurements.
RAID device ID	Alternate <b>Client</b>	Selects the RAID device ID mode
<b>Software feature mask configuration<sup>2)</sup></b>	Enter	Opens submenu " <a href="#">Software feature mask configuration</a> " on page 169
Aggressive LPM support	<b>Disabled</b> Enabled	Disables/Enables Aggressive Link Power Management The host controller can change to a low-power state in the idle phase of the SATA device.
Serial ATA port <i>n</i>	-	Displays the name and capacity of the SATA device
Software preserve	-	Displays support for the software preserve
Port <i>n</i>	Disabled <b>Enabled</b>	Disables/Enables SATA port <i>n</i>
Hot plug	<b>Disabled</b> Enabled	Disables/Enables hot plugging
Configured as eSATA	-	Displays hot plugging support of the device on the SATA port
Spin up device	<b>Disabled</b> Enabled	Disables/Enables spin up for the connected device on the SATA port
SATA device type	Hard disk drive <b>Solid-state drive</b>	Defines the SATA device type as HDD or SSD
Topology	Unknown ISATA <b>Direct connect</b> Default for port 0 and 1 Flex <b>M2</b> Default for port 2	Defines the SATA topology
SATA port <i>n</i> DevSlp	<b>Disabled</b> Enabled	Disables/Enables for the device on port <i>n</i>
DITO configuration	<b>Disabled</b> Enabled	Disables/Enables device sleep idle timeout
DITO value	INT Default: <b>625</b>	Defines the DITO value [ms] Range: 0 to 1023
DM value	INT Default: <b>15</b>	Defines the DITO multiplier Range: 0 to 15

Table 111: Advanced - PCH-IO configuration - SATA and RST configuration

- 1) SATA controller(s) must be enabled to be able to make additional configurations.
- 2) This submenu can only be configured if "SATA test mode" is enabled.
- 3) *n* corresponds to the available SATA ports that are indexed from 0 to *n*-1.

### Software feature mask configuration

BIOS parameter	Setting options	Description
HDD unlock	Disabled <b>Enabled</b>	Disables/Enables HDD unlock The HDD can be locked in the operating system by a password.
LED locate	Disabled <b>Enabled</b>	Disables/Enables LED locate Indicates that LED/SGPIO hardware is connected and pingable.
Use RST legacy OROM	<b>Disabled</b> Enabled	Disables/Enables rapid storage technology legacy option ROM for active CSM <sup>1)</sup>

Table 112: Advanced - PCH-IO configuration - SATA and RST configuration - Software feature mask configuration

BIOS parameter	Setting options	Description
RAID0	Disabled	Disables/Enables RAID0
	<b>Enabled</b>	
RAID1	Disabled	Disables/Enables RAID1
	<b>Enabled</b>	
RAID10	Disabled	Disables/Enables RAID10
	<b>Enabled</b>	
RAID5	Disabled	Disables/Enables RAID5
	<b>Enabled</b>	
Intel Rapid Recovery technology	Disabled	Disables/Enables Intel Rapid Recovery Technology (IRRT)
	<b>Enabled</b>	
OROM UI and banner	Disabled	Disables/Enables OROM UI If OROM UI is disabled, no information is displayed as long as all storage media are in normal operation.
	<b>Enabled</b>	
IRRT only on eSATA	Disabled	Disables/Enables IRRT only on eSATA Enable to make internal and eSATA drives available for IRRT storage media.
	<b>Enabled</b>	
Smart Response Technology	Disabled	Disables/Enables Smart Response Technology
	<b>Enabled</b>	
OROM UI normal delay	2 to 8 [s] Default: 2 s	Defines the delay time of the OROM UI splash screen [s]
RST force form	<b>Disabled</b>	Disables/Enables force form for Intel RST
	Enabled	
System acceleration with Intel Optane memory	Disabled	Disables/Enables Intel Optane support
	<b>Enabled</b>	

Table 112: Advanced - PCH-IO configuration - SATA and RST configuration - Software feature mask configuration

1) Compatibility support module

### 7.1.6.2.9.3 Security configuration

BIOS parameter	Setting options	Description
RTC lock	Disabled	Disables/Enables lock bytes 0x38 to 0x3F of RTC RAM
	<b>Enabled</b>	
BIOS lock	Disabled	Disables/Enables the PCH BIOS lock function The BIOS lock function must be enabled for SMM <sup>1)</sup> .
	<b>Enabled</b>	

Table 113: Advanced - PCH-IO configuration - Security configuration

1) System Management Mode

### 7.1.6.2.9.4 HD audio configuration

BIOS parameter	Setting options	Description
HD audio	Auto	Disables/Enables HD audio device detection or sets it to automatic Disables/Enables has a permanent effect. "Auto" is enabled if a device is present and disabled if a device is not present.
	<b>Disabled</b>	
	Enabled	
Audio DSP	Disabled	Disables/Enables audio digital signal processing
	<b>Enabled</b>	
PME enable	<b>Disabled</b>	Disables/Enables PME wake of HD audio controller during POST
	Enabled	

Table 114: Advanced - PCH-IO configuration - HD audio configuration

## 7.1.6.2.10 PCH-FW configuration

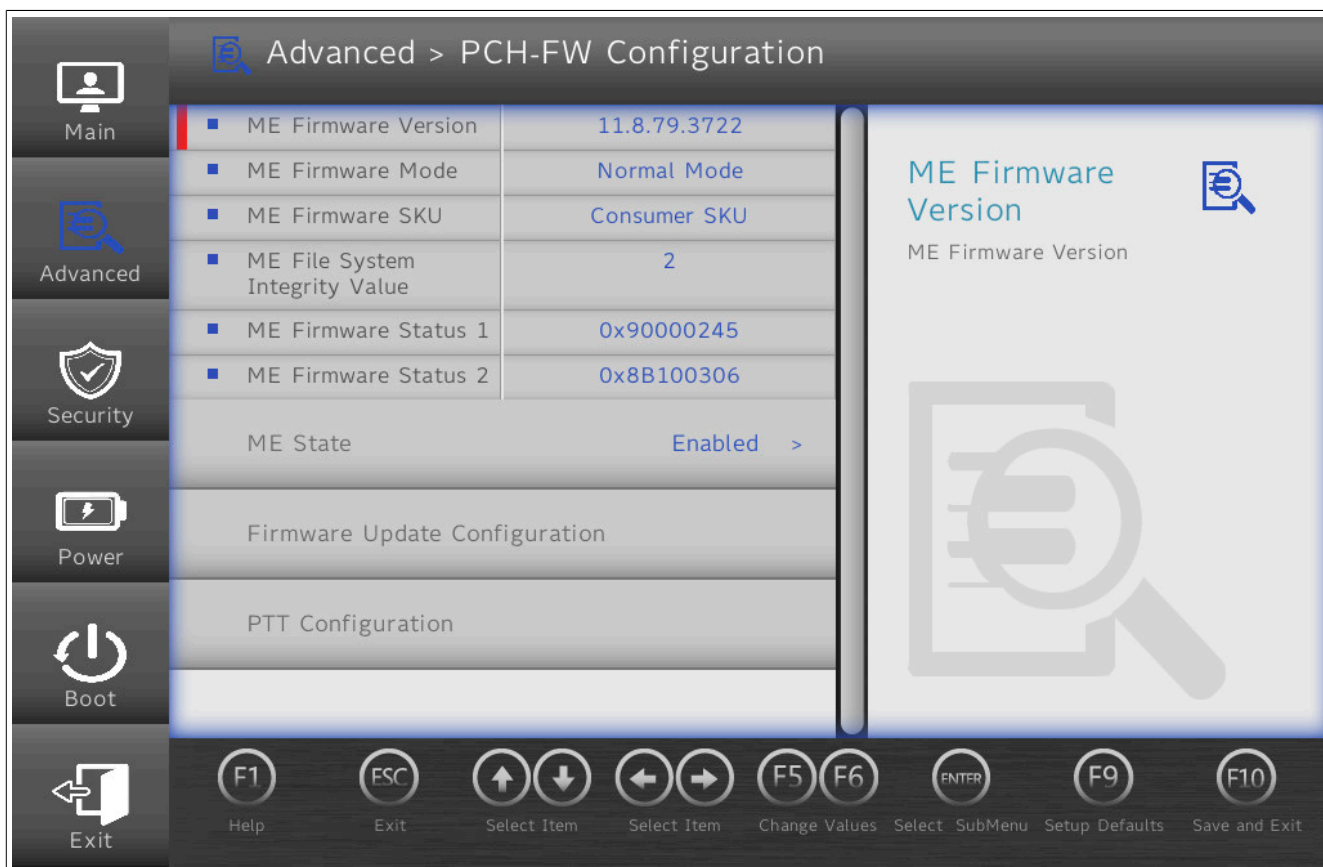

BIOS parameter	Input options	Description
ME <sup>1)</sup> firmware version	-	Displays the ME firmware version
ME firmware mode	-	Displays the ME firmware mode
ME firmware SKU	-	Displays the ME firmware SKU
ME file system integrity value	-	Displays the ME file system integrity value
ME firmware status 1	-	Displays ME firmware status 1
ME firmware status 2	-	Displays ME firmware status 2
ME state	Disabled	Disables/Enables ME state
	<b>Enabled</b>	
<b>Firmware update configuration</b>	Enter	Opens submenu "Firmware update configuration" on page 171
<b>PTT<sup>2)</sup> configuration</b>	Enter	Opens submenu "PTT configuration" on page 171

Table 115: Advanced - PCH-FW configuration

- 1) Intel Management Engine
- 2) Platform Trust Technology

## 7.1.6.2.10.1 Firmware update configuration

BIOS parameter	Setting options	Description
Me FW image re-flash	<b>Disabled</b>	Disables/Enables ME firmware image re-flash
	Enabled	
Local FW update	Disabled	Disables/Enables local firmware update
	<b>Enabled</b>	

Table 116: Advanced - PCH-FW configuration - Firmware update configuration

## 7.1.6.2.10.2 PTT configuration

BIOS parameter	Setting options	Description
PTT capability / state	-	Displays the PTT capability and status
PTP aware OS	<b>PTP aware</b>	Selects whether the operating system used is PTP-capable or not
	Not PTP aware	

Table 117: Advanced - PCH-FW configuration - PTT configuration

## 7.1.6.3 Security



BIOS parameter	Setting options	Description
Current TPM <sup>1)</sup> device	-	Displays the current TPM device
TPM state	-	Displays the TPM status
TPM active PCR hash algorithm	-	Displays the current PCR hash algorithm
TPM hardware support hash algorithm	-	Displays the hash algorithms supported by the hardware
TrEE protocol version	1.0 1.1	Selects the TrEE protocol version
TPM availability	Hidden Available	TPM invisible/visible for the operating system
TPM operation	No operation (Various)	Configuration of supported TPM functions The setting options of this parameter depend on whether FTPM or DTPM is used, see "Chipset configuration" on page 155.
Clear TPM	Disabled Enabled	Starts clearing TPM by enabling it
Supervisor password	-	Displays whether a supervisor password has been created
Set supervisor password	String	Sets or changes the supervisor password
Set all Hdd password	String	Sets all HDD passwords
Set all Hdd master password	String	Sets all HDD master passwords
Storage password setup page	Enter	Opens submenu "Storage password setup page" on page 172

Table 118: Security

1) Trusted Platform Module

### Information:

TPM commands are executed during the boot procedure.

The next time this menu is called after a boot procedure, parameter *TPM operation* shows "No operation" since the inputs have already been processed.

#### 7.1.6.3.1 Storage password setup page

BIOS parameter	Setting options	Description
CFast name <i>n</i> <sup>1)</sup>	Enter	Opens submenu "CFast name <i>n</i> " on page 173

Table 119: Security - Storage password setup page

1) Displays the manufacturer ID of the CFast card in the corresponding CFast slot. 2 CFast card slots are available. They are indexed from 1 to 2.

### 7.1.6.3.1.1 CFast name *n*

A total of 2 CFast card slots are available. They are indexed from 1 to 2.

BIOS parameter	Setting options	Description
Device name	-	Displays the manufacturer ID of the CFast card
Security mode	-	Displays the security mode of the CFast card
Set storage password	String	Sets the HDD password
Set master Hdd password	String	Sets the master HDD password

Table 120: Security - Storage password setup page - CFast name *n*

## 7.1.6.4 Power



BIOS parameter	Setting options	Description	
ACPI S3	Disabled	Disables/Enables ACPI S1/S3 sleep state	
	<b>Enabled</b>		
Wake on PME	Disabled	Disables/Enables wake on PME	
	<b>Enabled</b>		
Wake on modem ring	<b>Disabled</b>	Disables/Enables wake on modem ring	
	Enabled		
Auto wake on S5	<b>Disabled</b>	Disables auto wake on S5 or sets it to daily or a specific day of the month	
	By every day		
	By day of month		
Wake on S5 hour	INT	Defines the hour for auto wake on S5 daily Range: 0 to 23	
	Default: <b>0</b>		
	Wake on S5 minute		Defines the minute for auto wake on S5 daily Range: 0 to 59
	Default: <b>0</b>		
Wake on S5 second	INT	Defines the second for auto wake on S5 daily Range: 0 to 59	
	Default: <b>0</b>		
Day of month	INT	Defines the monthly day for auto wake on S5 Range: 1 to 31	
	Default: <b>1</b>		
S5 long run test	<b>Disabled</b>	Disables/Enables S5 long run test Enabling overrides some settings in the operating system.	
	Enabled		
USB standby power	-	Displays the USB standby power state	
Set USB standby power	Disabled	Disables/Enables the USB standby power	
	<b>Enabled</b>		
IF <sub>n</sub> <sup>1)</sup> standby power	-	Displays the IF <sub>n</sub> standby power states	
Set IF <sub>n</sub> standby power	Disabled	Disables/Enables the IF <sub>n</sub> standby power	
	<b>Enabled</b>		
Always-on	-	Displays the always-on state	
Set always-on	Disabled	Disables/Enables always-on	
	<b>Enabled</b>		

Table 121: Power

1) Depends on the configuration (max. 2 expansion options possible).

## 7.1.6.5 Boot



BIOS parameter	Setting options	Description
Boot type	<b>Dual boot type</b>	Selects the boot type
	Legacy boot type	In dual boot mode, both UEFI and Legacy boot are possible and the CSM is enabled.
	UEFI boot type	In Legacy boot mode, the CSM is enabled. In UEFI boot mode, the CSM is disabled.
Quick boot	Disabled <b>Enabled</b>	Disables/Enables quick boot If quick boot is enabled, certain tests are not performed so the boot procedure is faster.
Quiet boot	Disabled <b>Enabled</b>	Disables/Enables booting in text mode
Network stack	<b>Disabled</b> Enabled	Disables/Enables the network stack Enabling makes ETH booting possible.
PXE boot capability	<b>Disabled</b>	Disables PXE boot or selects the mode
	UEFI:IPV4	
	UEFI:IPV6	
	UEFI:IPV4/IVP6	
PXE boot to LAN	<b>Disabled</b> Enabled	Disables/Enables PXE boot to LAN
	Enabled	
Power up in standby support	<b>Disabled</b> Enabled	Disables/Enables power up in standby support
Add boot options	<b>Auto</b>	Selects or changes the mode of arrangement in the boot sequence for newly added devices Manual mode is not fully UEFI compatible.
	First	
	Manual	
	Last	
ACPI selection <sup>1)</sup>	Acpi1.0B	Selects the ACPI mode
	Acpi3.0	
	Acpi4.0	
	<b>Acpi5.0</b>	
	Acpi6.0	
	Acpi6.1	
USB boot	Disabled <b>Enabled</b>	Disables/Enables USB boot
	Enabled	
EFI device first	Disabled <b>Enabled</b>	Disables/Enables EFI device first Enable to boot EFI devices before legacy devices. Disable to boot legacy devices before EFI devices. <sup>2)</sup>
	Enabled	
Timeout	INT Default: <b>0</b>	Delay time until the boot list is processed [s] Range: 0 to 99

Table 122: Boot

BIOS parameter	Setting options	Description
Automatic failover	Disabled	Disables/Enables automatic failover
	<b>Enabled</b>	
EFI	Enter	Opens submenu "EFI" on page 176
Legacy	Enter	Opens submenu "Legacy" on page 177

Table 122: Boot

- 1) When changing the ACPI version, make sure that the operating system used is compatible.
- 2) This parameter must be disabled to use ARwin and B&R Hypervisor.

### 7.1.6.5.1 EFI

BIOS parameter	Setting options	Description
EFI	Enter	Opens submenu "EFI" on page 176
1st device	<b>CFast 1</b>	Selects this device as first in the boot sequence
	CFast 2	
	ETH1 IPv4	
	ETH1 IPv6	
	USB storage	
	Internal EFI shell	
	Other	
	M.2	
	USB CD-ROM	
	USB other	
	RAID volume	
	Disabled	
	2nd device <sup>1)</sup>	
3rd device	<b>M.2</b>	Selects this device as third in the boot sequence
4th Device	<b>USB storage</b>	Selects this device as fourth in the boot sequence
5th device	<b>USB CD-ROM</b>	Selects this device as fifth in the boot sequence
6th device	<b>USB other</b>	Selects this device as sixth in the boot sequence
7th device	<b>Internal EFI shell</b>	Selects this device as seventh in the boot sequence
8th device	<b>ETH1 IPv4</b>	Selects this device as eighth in the boot sequence

Table 123: Boot - EFI

- 1) Starting with the *2nd device*, only the respective default values are specified.

#### 7.1.6.5.1.1 EFI

BIOS parameter	Setting options	Description
EFI	Enter, then: <ul style="list-style-type: none"> <li>▶ Keyboard: F5/F6</li> <li>▶ Touch screen: Move items at the gray arrows</li> </ul>	Defines the boot sequence

Table 124: Boot - EFI - EFI



### 7.1.6.5.2 Legacy

BIOS parameter	Setting options	Description
boot menu	<b>Normal</b>	Selects the boot sequence type
	Advanced	
<b>Boot type order</b>	Enter	Opens submenu " <a href="#">"Boot type order" on page 177</a>
<b>Other</b>	Enter	Opens submenu <sup>1)</sup>
<b>Floppy disk</b>	Enter	
<b>Hard disk drive</b>	Enter	Opens submenu " <a href="#">"Hard disk drive" on page 177</a>
<b>CD/DVD-ROM drive</b>	Enter	Opens submenu <sup>1)</sup>
<b>USB</b>	Enter	
Legacy	Enter, then: <ul style="list-style-type: none"> <li>▶ Keyboard: F5/F6</li> <li>▶ Touch screen: Move items at the gray arrows</li> </ul>	Defines the boot sequence

Table 125: Boot - Legacy

- 1) These submenus are only available if at least one corresponding device is available. Their structure corresponds to that of submenu **Hard disk drive**.

#### 7.1.6.5.2.1 Boot type order

BIOS parameter	Setting options	Description
<b>Boot type order</b>	Enter	Opens submenu " <a href="#">"Boot type order" on page 177</a>

Table 126: Boot - Legacy - Boot type order

#### Boot type order

BIOS parameter	Setting options	Description
Boot type order	Enter, then: <ul style="list-style-type: none"> <li>▶ Keyboard: F5/F6</li> <li>▶ Touch screen: Move items at the gray arrows</li> </ul>	Defines the boot sequence

Table 127: Boot - Legacy - Boot type order - Boot type order

#### 7.1.6.5.2.2 Hard disk drive

BIOS parameter	Setting options	Description
<b>Hard disk drive</b>	Enter	Opens submenu " <a href="#">"Hard disk drive" on page 177</a>

Table 128: Boot - Legacy - Hard disk drive

#### Hard disk drive

BIOS parameter	Setting options	Description
Hard disk drive	Enter, then: <ul style="list-style-type: none"> <li>▶ Keyboard: F5/F6</li> <li>▶ Touch screen: Move items at the gray arrows</li> </ul>	Defines the boot sequence

Table 129: Boot - Legacy - Hard disk drive - Hard disk drive

## 7.1.6.6 Exit

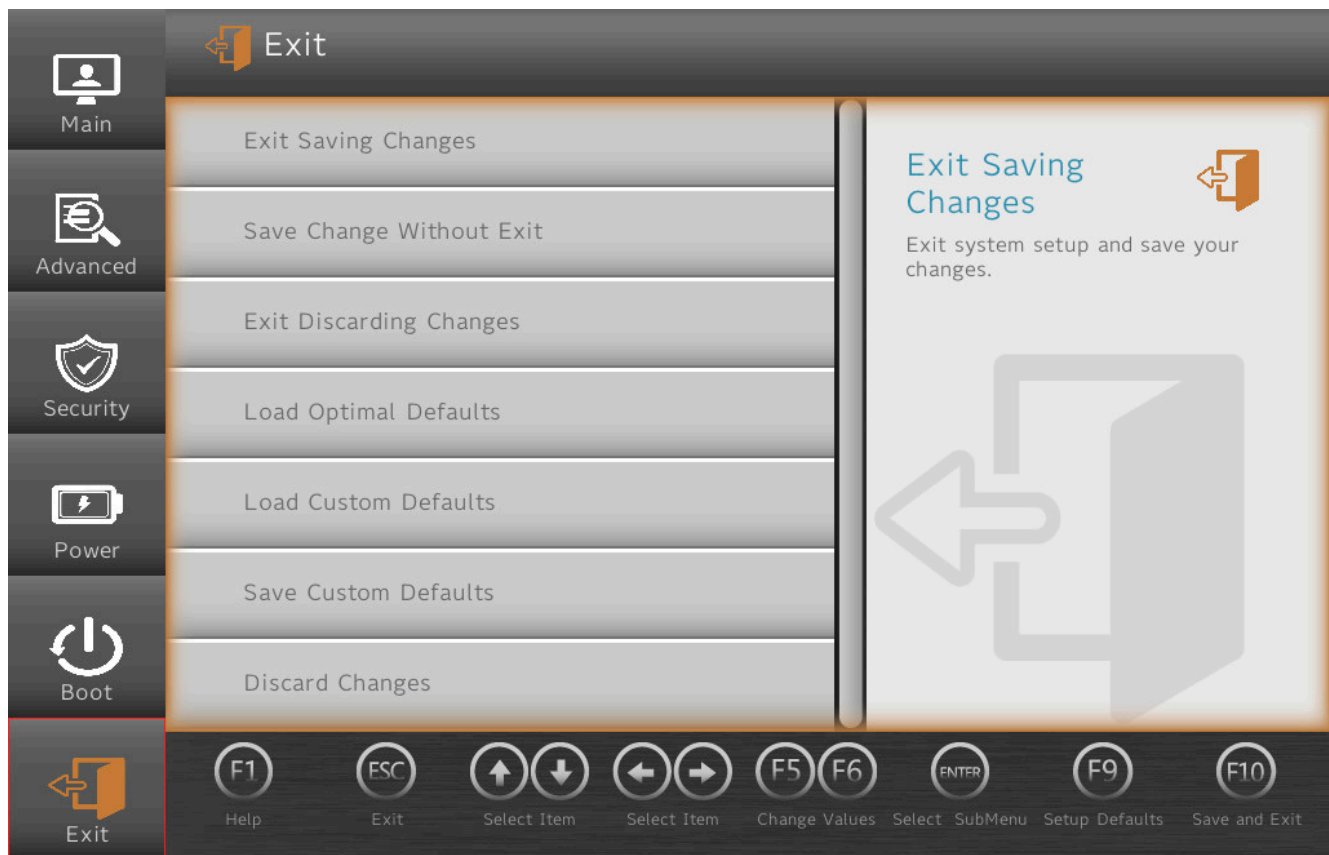

BIOS parameter	Setting options	Description
Exit saving changes	Enter	Saves changes and restarts
Save changes without exit	Enter	Saves changes Some settings only take effect after a restart.
Exit discarding changes	Enter	Discards changes and exits
Load optimal defaults	Enter	Loads system-optimized default values
Load custom defaults	Enter	Loads user-specific default values
Save custom defaults	Enter	Saves user-specific default values
Discard changes	Enter	Discards changes

Table 130: Exit

## 7.2 Upgrade information

### Warning!

The BIOS and firmware on B&R devices must always be kept up to date. New versions can be downloaded from the B&R website ([www.br-automation.com](http://www.br-automation.com)).

### 7.2.1 UEFI BIOS upgrade

An upgrade may be necessary for making updated or new functions available.

For a detailed description of changes, see file *Readme.txt* or *Liesmich.txt*, which is included in every upgrade archive (ZIP).

### Information:

Individually saved setup settings are deleted during a UEFI BIOS upgrade.

#### 7.2.1.1 BIOS upgrade

The installed software versions should be determined before an upgrade is started.

##### 7.2.1.1.1 Displaying firmware and BIOS version information

Information about the BIOS version and firmware is available in BIOS menu *OEM features*:

1. After switching on the APC3100, open BIOS Setup with **[Esc]**, **[Del]** or **[F2]**.
2. The installed versions are displayed under **Setup utility / Advanced / OEM features**, see figure (symbolic).

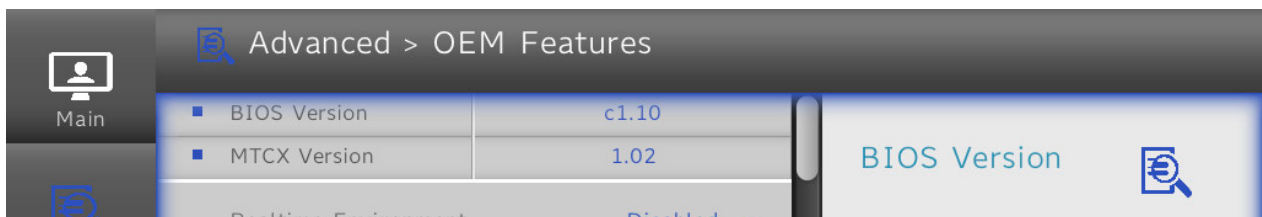

#### 7.2.1.2 Procedure in the EFI shell

### Caution!

The PC is not permitted to be switched off or reset while performing an upgrade!

1. Download the ZIP file from the B&R website ([www.br-automation.com](http://www.br-automation.com)).
2. Unzip the ZIP file and copy the files to a USB flash drive formatted in *FAT16* or *FAT32*. Alternatively, a CFast card can also be used.
3. Reboot the PC, open the boot menu with **[Esc]**, **[Del]** or **[F2]** and select *Internal EFI shell* as the boot device.
4. After booting the EFI shell, *startup.nsh* is executed and the UEFI BIOS upgrade is started.

### Information:

With an "Extended" update (e.g. Intel ME firmware), several reboots are necessary.

The instructions during the update process must be followed until the upgrade installation is completed with the message "BIOS update done".

5. After a successful upgrade, the system must be switched off and on again for the upgrade to take effect. Call the boot menu with **[Esc]**, **[Del]** or **[F2]** during the following boot procedure and load the setup defaults and accept them with *Save changes and exit*.
- ✓ The upgrade is installed and in effect.

## 7.2.2 PC firmware upgrade

With *Firmware upgrade (MTCX, SDLT, SDL4T)*, it is possible to update the firmware of several controllers (MTCX, SDLT, SDL4T) depending on the variant of the Automation PC system.

A current firmware upgrade can be downloaded directly from the Downloads section of the B&R website ([www.br-automation.com](http://www.br-automation.com)).

### Caution!

**The PC is not permitted to be switched off or reset while performing an upgrade!**

### 7.2.2.1 Procedure in Windows (ADI Control Center)

1. Download the ZIP file from the B&R website ([www.br-automation.com](http://www.br-automation.com)).
  2. Open the *ADI Control Center* in the Control Panel.
  3. Open tab **Versions**.
  4. Click on the desired update under **PC firmware** or **Panel firmware**. The dialog box opens.
  5. Enter the name of the firmware file or select a file under "Filename".
  6. Execute file with **Open**.
  7. After a successful upgrade, the system must be switched off and on again for the upgrade to take effect.
- ✓ The upgrade is installed and in effect.

The transfer can be canceled by clicking on **Cancel** in dialog box "Download". This is disabled while writing to flash memory.

Erasing the data in flash memory can take several seconds depending on the memory module used. During this time, the progress indicator is not updated.

### Information:

**For more detailed information about saving and updating the firmware, see the ADI driver user's manual. This is available for download at [www.br-automation.com](http://www.br-automation.com).**

### 7.2.2.2 Procedure in the EFI shell

1. Download the ZIP file from the B&R website ([www.br-automation.com](http://www.br-automation.com)).
  2. Unzip the ZIP file and copy the files to a USB flash drive formatted in *FAT16* or *FAT32*. Alternatively, a CFast card can also be used.
  3. Reboot the PC, open the boot menu with **[Esc]**, **[Del]** or **[F2]** and select *Internal shell* as the boot device.
  4. After booting the EFI shell, *startup.nsh* is executed and the MTCX, SDLT and SDL4T upgrades are started in sequence.
  5. After a successful upgrade, the system must be switched off and on again for the upgrade to take effect.
- ✓ The upgrade is installed and in effect.

### 7.2.2.3 Automatic firmware upgrade

With the APC3100/PPC3100, it is possible to perform updates automatically.

For this, parameter **Automatic firmware update** must be enabled in BIOS (see "[Advanced - OEM features](#)" on [page 149](#)).

A current firmware upgrade can be downloaded directly from the Downloads section of the B&R website ([www.br-automation.com](http://www.br-automation.com)).

Upgrades are provided as a *ZIP* file and include a readme file (*TXT* file) that provides additional information.

For automatic upgrades, the upgrade files must be stored in a directory named "XPC3100FWU" that is located in the root directory of a data storage medium formatted in *FAT32* (e.g. CFast card or USB flash drive). The following figure shows the view of a suitable data storage medium with an upgrade.

```

UEFI Interactive Shell v2.1
EDK II
UEFI v2.50 (INSYDE Corp., 0x57091034)
Mapping table
FS0: Alias(s):HD9d0a0;:BLK0:
    PciRoot(0x0)/Pci(0x14,0x0)/USB(0x3,0x0)/USB(0x0,0x0)
FS1: Alias(s):HD17b;:BLK2:
    PciRoot(0x0)/Pci(0x1C,0x4)/Pci(0x0,0x0)/NVMe(0x1,39-42-30-31-01-75-A0-00)/HD(1,GPT,91ACEEB0-09F5-47F1-8DB9-3056C936569E,0x800,0x82000)
FS2: Alias(s):HD17e;:BLK5:
    PciRoot(0x0)/Pci(0x1C,0x4)/Pci(0x0,0x0)/NVMe(0x1,39-42-30-31-01-75-A0-00)/HD(4,GPT,C8BE64E7-8383-4639-8EC2-7B54B96449F5,0x3A5E1000,0x500000)
FS3: Alias(s):HD17f;:BLK6:
    PciRoot(0x0)/Pci(0x1C,0x4)/Pci(0x0,0x0)/NVMe(0x1,39-42-30-31-01-75-A0-00)/HD(5,GPT,C0595E7F-4152-48D2-810C-D3A85C6CBEC1,0x3AAE1000,0x50B800)
FS4: Alias(s):HD17g;:BLK7:
    PciRoot(0x0)/Pci(0x1C,0x4)/Pci(0x0,0x0)/NVMe(0x1,39-42-30-31-01-75-A0-00)/HD(6,GPT,F1419F55-E303-47F0-B93C-94ACCD18908E,0x3AFEC800,0x4E6000)
FS5: Alias(s):HD17h;:BLK8:
    PciRoot(0x0)/Pci(0x1C,0x4)/Pci(0x0,0x0)/NVMe(0x1,39-42-30-31-01-75-A0-00)/HD(7,GPT,54207C90-88D5-4D5B-A6A7-2B614DE26665,0x3B4D2800,0x50EA8F)
BLK1: Alias(s):
    PciRoot(0x0)/Pci(0x1C,0x4)/Pci(0x0,0x0)/NVMe(0x1,39-42-30-31-01-75-A0-00)
BLK3: Alias(s):
    PciRoot(0x0)/Pci(0x1C,0x4)/Pci(0x0,0x0)/NVMe(0x1,39-42-30-31-01-75-A0-00)/HD(2,GPT,FD3F9176-9DA7-4DCE-A62A-C9AECC9C8E81,0x82800,0x8000)
BLK4: Alias(s):
    PciRoot(0x0)/Pci(0x1C,0x4)/Pci(0x0,0x0)/NVMe(0x1,39-42-30-31-01-75-A0-00)/HD(3,GPT,D868DD6F-8522-4994-874A-7639145F510C,0x8A800,0x3A556800)
Press ESC in 2 seconds to skip startup.nsh or any other key to continue.
Shell> fs0:
FS0:\> cd XPC3100FWU
FS0:\XPC3100FWU> dir
Directory of: FS0:\XPC3100FWU\
08/14/2019  14:58 <DIR>          4,096  .
08/14/2019  14:58 <DIR>              0  ..
03/23/2021  17:12                3,145,863  10402_0_fw
03/23/2021  17:12                3,145,863  63893_0_fw
03/23/2021  17:18                  4,745  Liesmich.txt
11/26/2020  17:21                  1,002  HTCXXPC3100.nsh
07/16/2020  13:43                428,800  wtcsxvc.efi
03/23/2021  17:18                  4,622  Readme.txt
11/26/2020  17:21                  605  startup.nsh
              7 File(s)    6,731,500 bytes
              2 Dir(s)
FS0:\XPC3100FWU>

```

## Information:

The automatic update only takes place if the installed firmware version differs from the upgrade version.

Automatic downgrades are possible!

## 7.2.3 Automation Panel firmware upgrade

With *Firmware upgrade (Automation Panel, SDL3 Converter, SLD4 converter)*, it is possible to update the firmware of several controllers (SDLR, SDL3R, SDL4R, SDL3 Converter, SDL4 Converter) depending on the variant of the system.

A current firmware upgrade can be downloaded directly from the Downloads section of the B&R website ([www.br-automation.com](http://www.br-automation.com)).

### Caution!

**The Automation Panel is not permitted to be switched off or reset while performing an upgrade!**

#### 7.2.3.1 Procedure in Windows (ADI Control Center)

1. Download the ZIP file from the B&R website ([www.br-automation.com](http://www.br-automation.com)).
  2. Open the *ADI Control Center* in the Control Panel.
  3. Open tab **Versions**.
  4. Click on the desired update under **PC firmware** or **Panel firmware**. The dialog box opens.
  5. Enter the name of the firmware file or select a file under "Filename".
  6. Execute file with **Open**.
  7. After a successful upgrade, the system must be switched off and on again for the upgrade to take effect.
- ✓ The upgrade is installed and in effect.

The transfer can be canceled by clicking on **Cancel** in dialog box "Download". This is disabled while writing to flash memory.

Erasing the data in flash memory can take several seconds depending on the memory module used. During this time, the progress indicator is not updated.

### Information:

**For more detailed information about saving and updating the firmware, see the ADI driver user's manual. This is available for download at [www.br-automation.com](http://www.br-automation.com).**

#### 7.2.3.2 Procedure in the EFI shell

1. Download the ZIP file from the B&R website ([www.br-automation.com](http://www.br-automation.com)).
  2. Unzip the ZIP file and copy the files to a USB flash drive formatted in *FAT16* or *FAT32*. Alternatively, a CFast card can also be used.
  3. Reboot the PC, open the boot menu with **[Esc]**, **[Del]** or **[F2]** and select *Internal EFI shell* as the boot device.
  4. After booting the EFI shell, *startup.nsh* is executed and the SDLR and SDL4R upgrades are started in sequence.
  5. After a successful upgrade, a the system must be switched off and on again.
- ✓ The upgrade is installed and in effect.

### Information:

**The power supply to the PC or Automation Panel must be switched off and on again for the new firmware to take effect and the updated version to be displayed.**

## 7.3 RAID configuration

### Note:

When creating a RAID volume, existing data on the storage media is deleted.

Before creating a RAID volume, make sure that there is no important data on the storage media.

In order to create a SATA RAID volume and access the "Configuration utility", setting *SATA mode selection* in BIOS menu "SATA and RST configuration" (see "PCH-IO configuration" on page 166) must be set to *Intel RST premium with Intel Optane*.

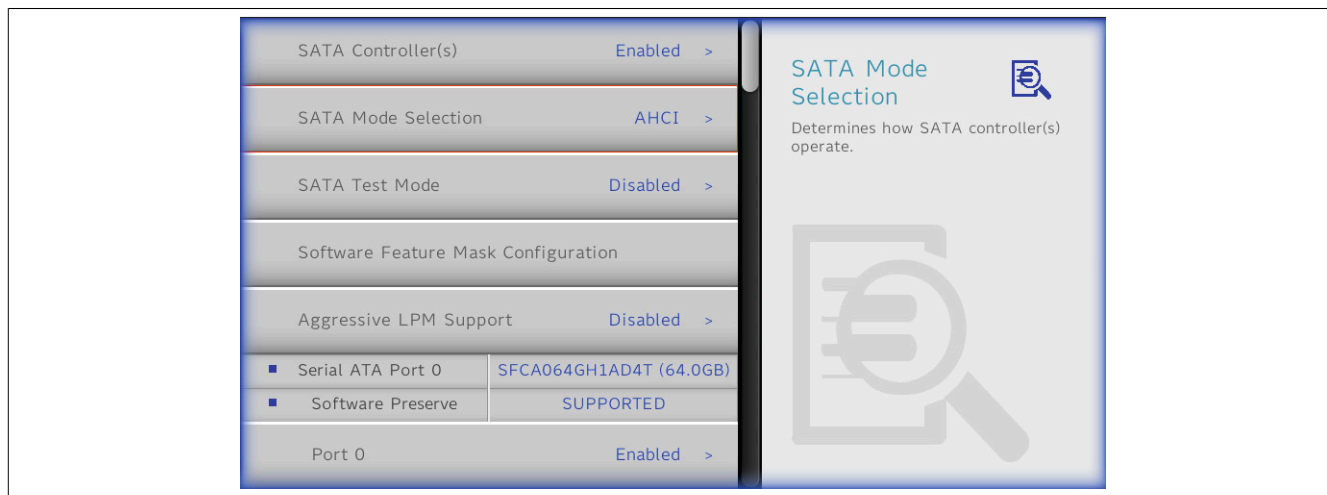

Figure 6: Advanced - PCH-IO configuration - SATA and RST configuration - SATA mode selection

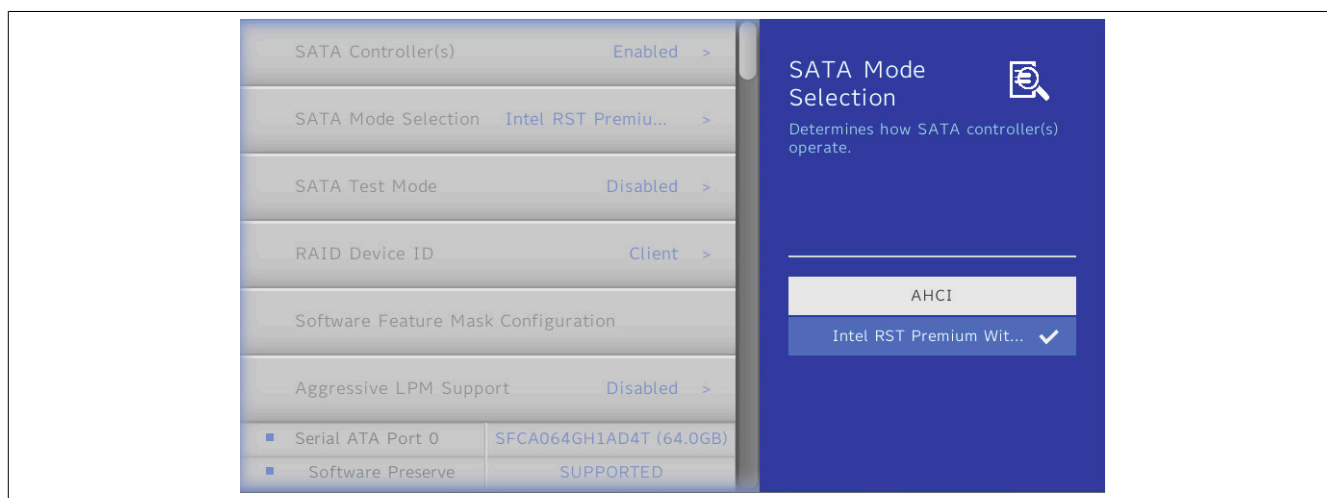

Figure 7: Configured SATA mode selection for RAID volume

### Information:

This setting is required for legacy and UEFI boot mode.

## 7.3.1 Legacy RAID

### 7.3.1.1 Configuring a SATA RAID volume with the internal RAID controller

The following software description applies to the internal RAID controller on *KabyLake-U* chipset.

#### Information:

B&R recommends using only the same drive type in the SATA RAID volume.

#### Caution!

The maximum number of possible write cycles must be taken into account when setting up a RAID volume with CFast cards with MLC technology.

The "Configuration utility" in BIOS must be started after the reboot for the configuration. After POST, press <Ctrl+I> to open the RAID BIOS.

#### Information:

Since the associated driver is not yet loaded at this point, touch screen input is not possible in the "Configuration utility".

Input in the RAID menu are always processed according to the QWERTY schema. This is also the case if a QWERTZ USB input device is connected.

```
Intel(R) Rapid Storage Technology - Option ROM - 15.7.0.3054
Copyright(C) Intel Corporation. All Rights Reserved.

RAID Volumes:
ID   Name           Level           Strip           Size           Status           Bootable
0    Mirror          RAID1 (Mirror)  N/A             59.6GB          Normal           Yes

Physical Devices:
ID   Device Model    Serial #        Size           Type/Status (Vol ID)
0    SFCA064GH1AD4TO- 60143158A6000044 59.6GB          Member Disk (0)
1    SFCA064GH1AD4TO- 60143158A6000058 59.6GB          Member Disk (0)

Press <CTRL-I> to enter Configuration Utility..
```

Figure 8: RAID boot

```
Intel(R) Rapid Storage Technology - Option ROM - 15.7.0.3054
Copyright(C) Intel Corporation. All Rights Reserved.

[ MAIN MENU ]
1. Create RAID Volume           4. Recovery Volume Options
2. Delete RAID Volume          5. Acceleration Options
3. Reset Disks to Non-RAID     6. Exit

[ DISK/VOLUME INFORMATION ]

RAID Volumes:
None defined.

Physical Devices:
ID   Device Model    Serial #        Size           Type/Status (Vol ID)
0    SFCA064GH1AD4TO- 60143158A6000044 59.6GB          Non-RAID Disk
1    SFCA064GH1AD4TO- 60143158A6000058 59.6GB          Non-RAID Disk

[↑↓]-Select           [ESC]-Exit           [ENTER]-Select Menu
```

Figure 9: RAID - Configuration utility - Overview

The following keys can be used after entering BIOS Setup:

Key	Function
Cursor (↑, ↓)	Navigation in the menu and between objects.
Enter	Selects an item or opens a submenu.
ESC	Returns to the previous menu.

Table 131: BIOS-relevant keys in the RAID Configuration Utility



Key	Function
Ctrl+E	Saves any changed settings and exits setup.
Z/Y	Confirm ("Yes"). (QWERTZ/QWERTY)
N	Cancel ("No").
Pause	Booting is paused, resume by pressing any key.

Table 131: BIOS-relevant keys in the RAID Configuration Utility

## 7.3.1.2 Create RAID volume

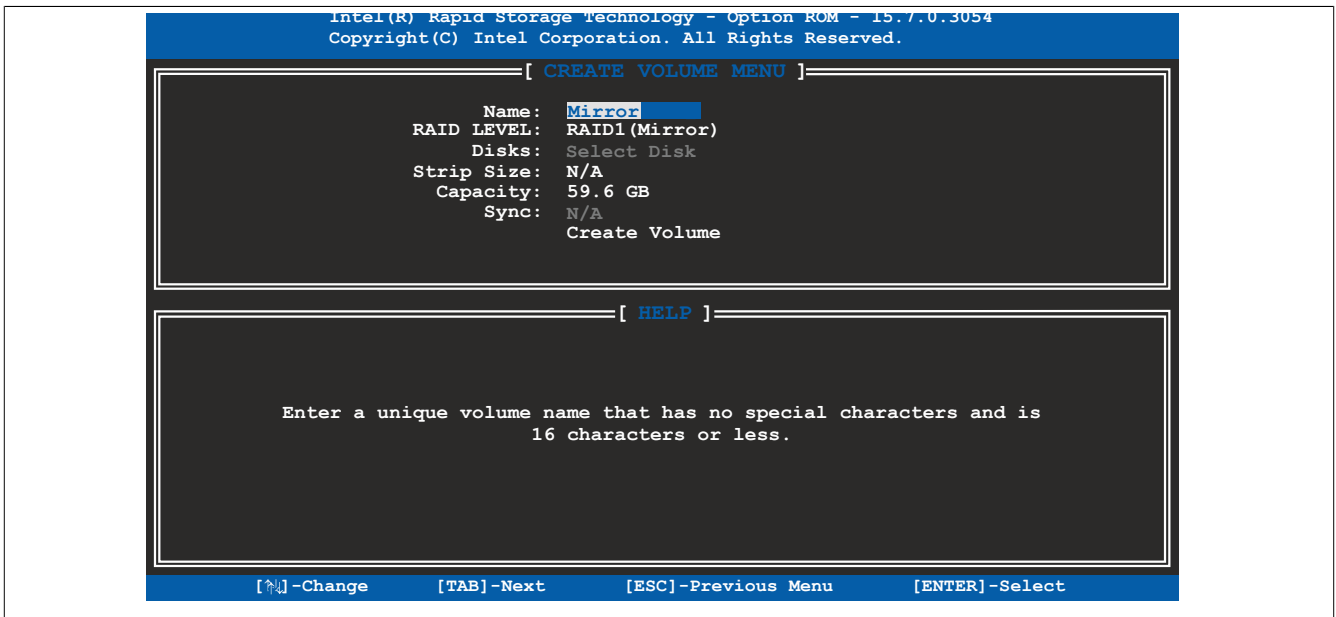

Figure 10: Creating a RAID volume

BIOS parameter	Setting options	Description
Name	String Default: <b>Volume1</b>	Name for the RAID volume No special characters are permitted. Range: Max. 16 characters
RAID level <sup>1)</sup>	<b>RAID0 (Stripes)</b>	Selects the RAID level
	RAID1 (Mirror)	
	Recovery	
Disks <sup>2)</sup>	Master	Defines the storage media mode
	Recovery	
Strip size <sup>3)</sup>	4 kB	Selects the data block size [kB]
	8 kB	
	<b>16 kB</b>	
	32 kB	
	128 kB	
Capacity	INT	Defines the RAID memory size Range: Hardware-dependent If storage media of different sizes are used, this is limited to the smaller medium.
Sync <sup>4)</sup>	<b>Continuous</b>	Selects the synchronization mode
	On request	
Create volume	Enter	Creates a RAID volume according to the configuration

Table 132: Configuration Utility - Create RAID volume

- 1) Grayed-out parameters cannot be modified in the currently selected RAID level.
- 2) This setting is only possible if *RAID level* is set to *Recovery*.
- 3) This setting is only possible if *RAID level* is set to *RAID0(Stripe)*.
- 4) This setting is only possible if *RAID level* is set to *Recovery*.

### 7.3.1.3 Delete RAID volume

Menu option "Delete RAID volume" can be used to format the RAID drive, making it non-RAID. The drive to be deleted is selected and then deleted by pressing <DEL>.

#### Information:

This option deletes all data on the drive, including the operating system.

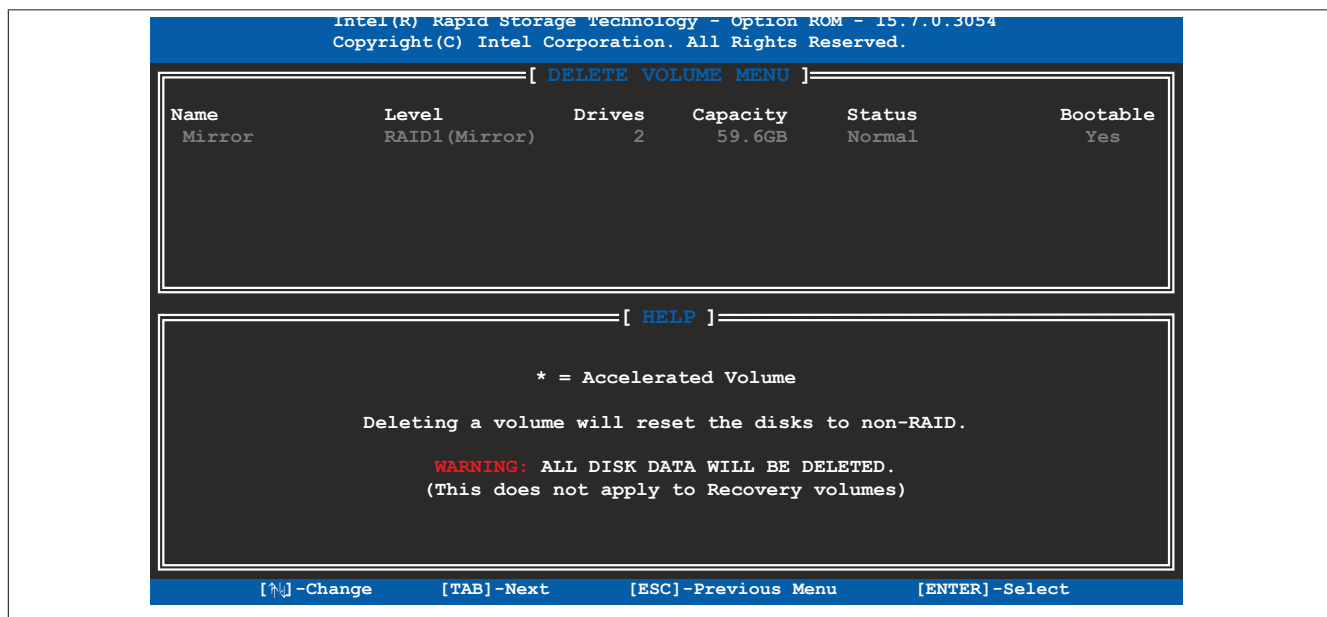

Figure 11: Deleting the RAID volume

### 7.3.1.4 Recovery volume options

Menu option "Recovery volume options" can be used to enable/disable recovery disk and master disk.

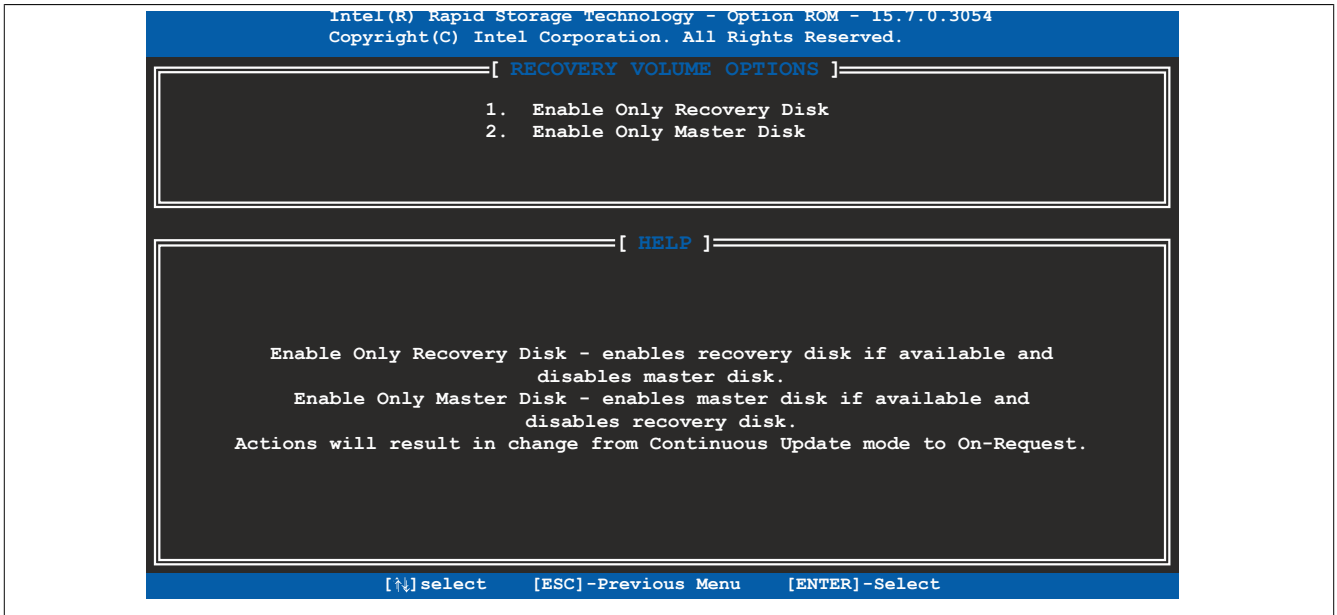

Figure 12: RAID recovery

#### Note:

Changes in this menu affect the synchronization mode.

### 7.3.1.5 Reset disks to non-RAID

An existing RAID volume can be deleted using option "Reset disks to non-RAID". The RAID to be deleted is selected and then deleted by pressing <SPACE> (<ENTER> to confirm).

#### Information:

Deleting a RAID volume also deletes all of the data on the drive.

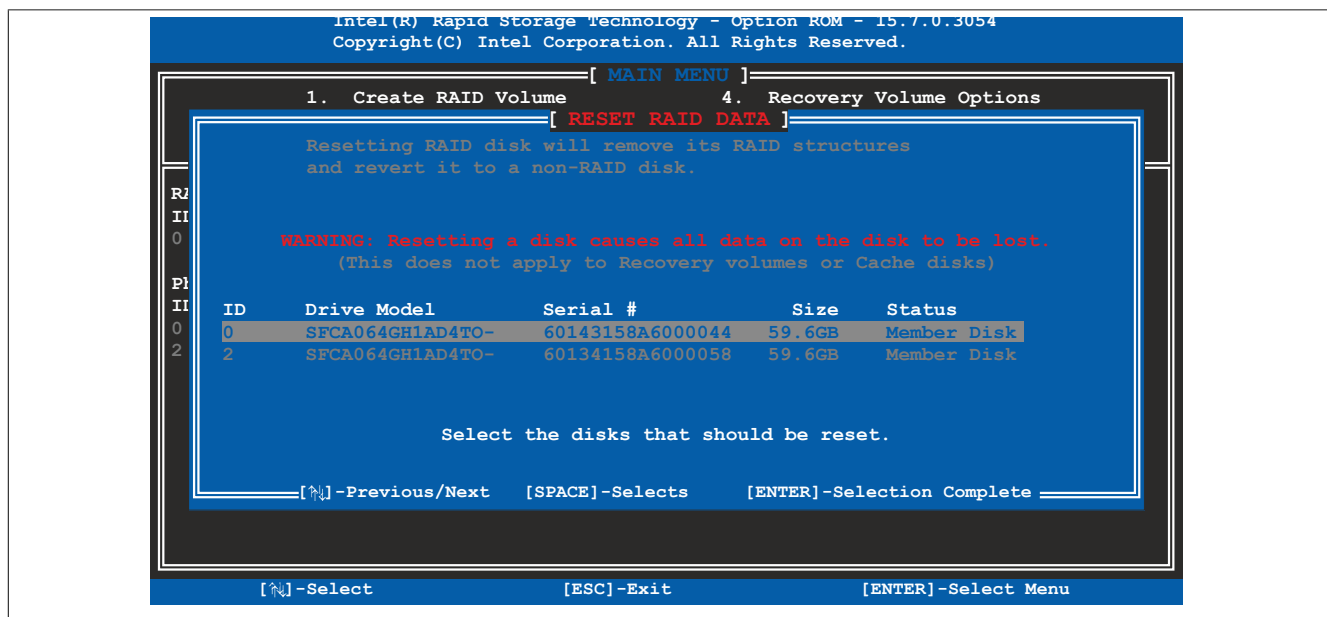

Figure 13: Resetting the RAID volume

## 7.3.2 UEFI RAID

### 7.3.2.1 Configuring a SATA RAID volume with the internal RAID controller

The following software description applies to the internal RAID controller on *KabyLake-U* chipset.

#### Information:

**B&R recommends using only the same drive type in the SATA RAID volume.**

#### Caution!

**The maximum number of possible write cycles must be taken into account when setting up a RAID volume with CFast cards with MLC technology.**

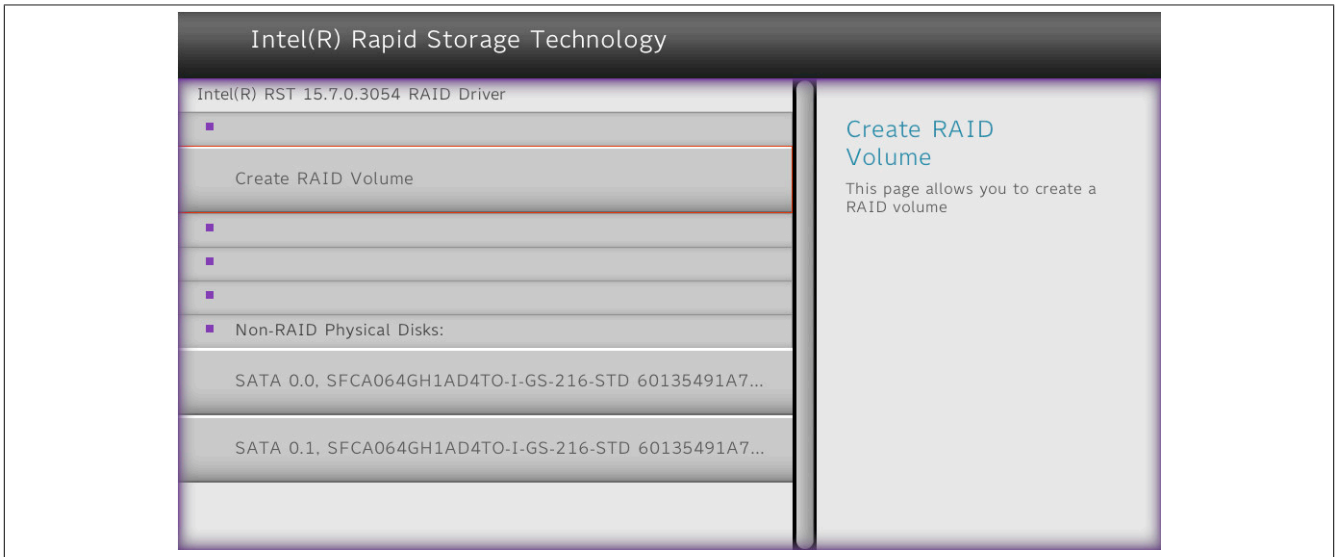

Figure 14: Device manager

Use submenu "Intel(R) Rapid Storage Technology" to navigate to the configuration of the RAID volume.

The following keys can be used in the device manager:

Key	Function
Cursor (↑, ↓)	Navigation in the menu and between objects.
Enter	Selects an item or opens a submenu.
ESC	Exits.

Table 133: Keys in the device manager

### 7.3.2.2 Create RAID volume

RAID volumes can be created via submenu "Create RAID volume" on page 144 in section "Intel® Rapid Storage Technology" on page 144.

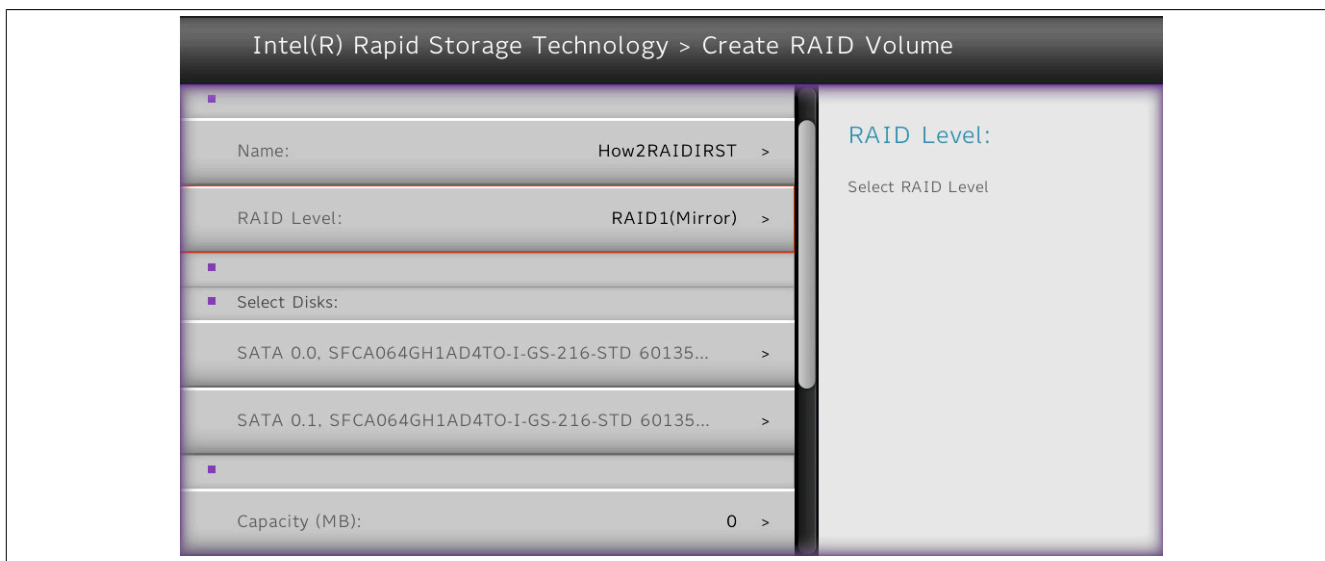

Figure 15: Creating a RAID volume

BIOS parameter	Setting options	Description
Name:	String Default: <b>Volume1</b>	Name for the RAID volume No special characters are permitted. Range: Max. 16 characters
RAID level:	<b>RAID0 (stripe)</b> RAID1 (mirror) Recovery	Selects the RAID level
Select disks:		
Disk n:	(Blank) X M R	Selects the storage medium for the RAID volume. Either X (RAID0 and RAID1) or M (master) /R (recovery) can be defined (recovery mode).
Stripe size:	4 kB 8 kB <b>16 kB</b> 32 kB 64 kB 128 kB	Selects the data block size [kB]
Capacity:	INT	Defines the RAID memory size [MB] Range: Hardware-dependent If storage media of different sizes are used, this is limited to the smaller medium.
Synchronization:	<b>Continuous</b> On request	Selects the synchronization mode

Table 134: Device manager - Create RAID volume

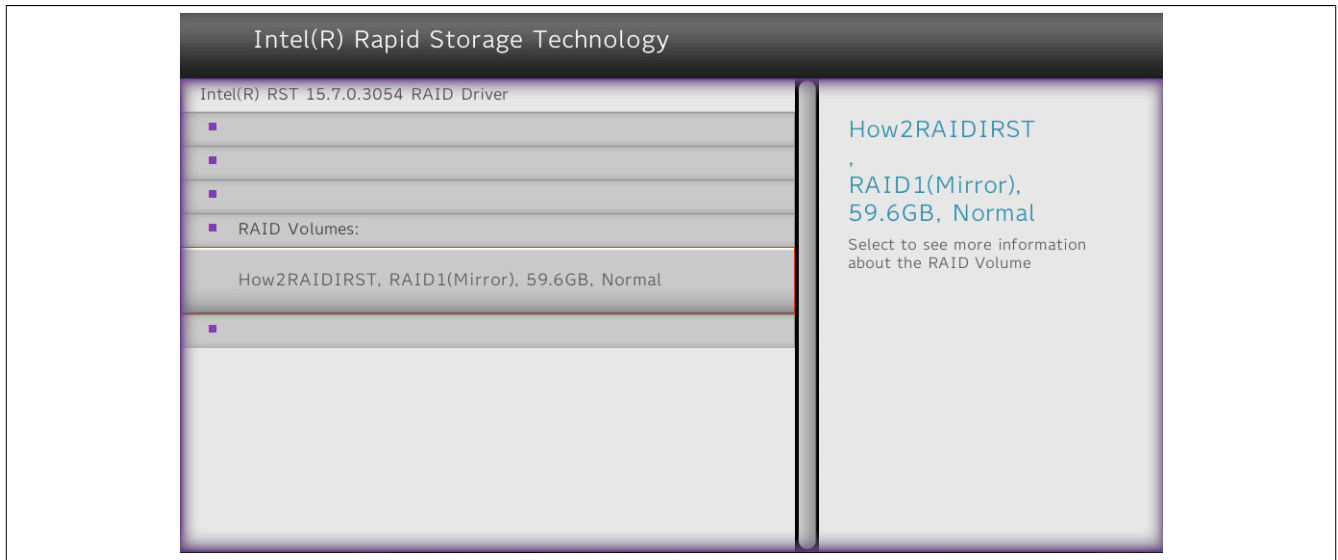

Figure 16: Intel® Rapid Storage Technology with created RAID volume (RAID1)



### 7.3.2.3 Delete RAID volume

Use function "Delete" (in section "RAID volume info" on page 145) to delete existing RAID volumes and reformat individual drives to non-RAID.

#### Information:

This option deletes all data on the drive, including the operating system.

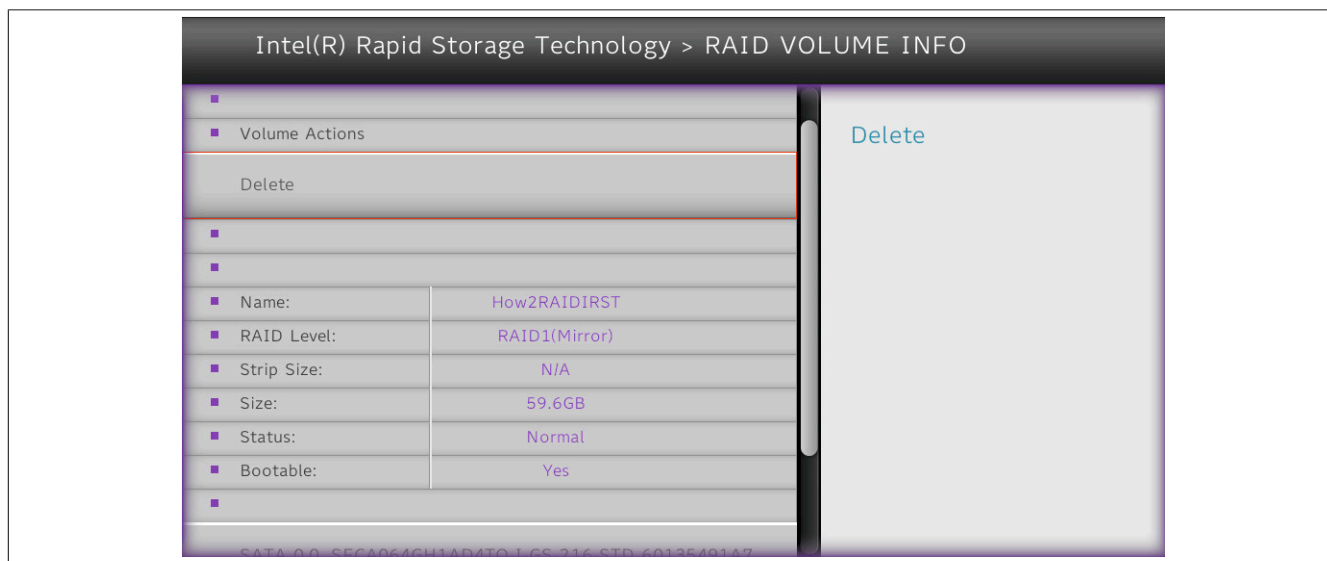

Figure 17: Deleting a RAID volume

### 7.3.2.4 Recovery volume options

For RAID volumes associations in recovery mode, there is the option to enable or disable only the recovery disk or master disk. This option is available in menu "RAID volume info" on page 145.

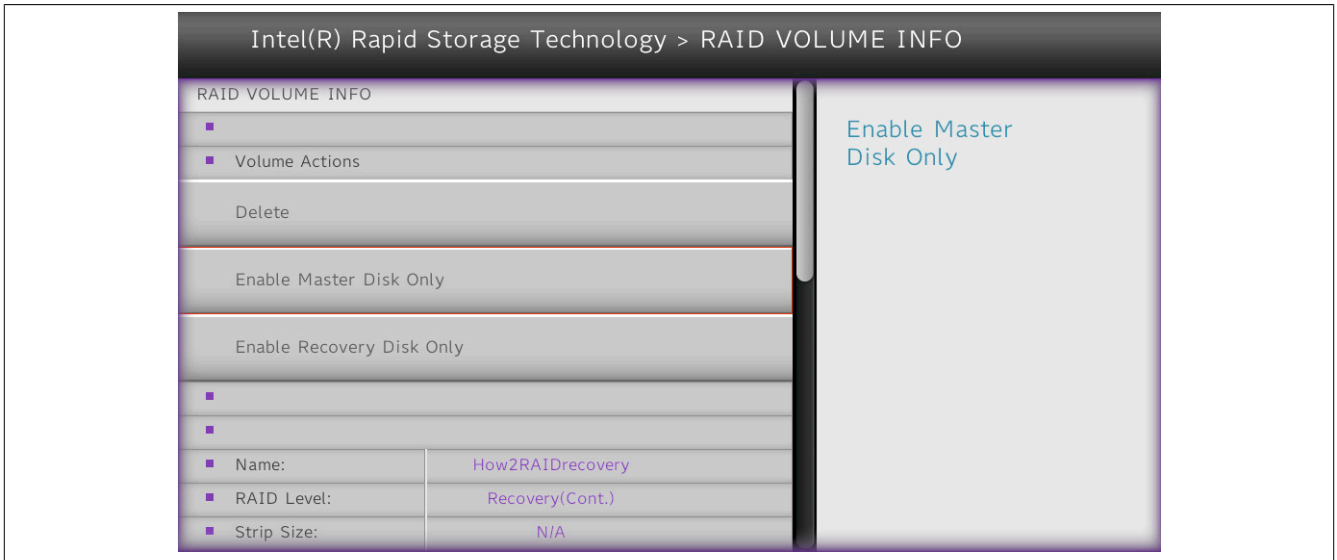

Figure 18: RAID recovery

#### Note:

Changes in this menu affect the synchronization mode.

### 7.3.2.5 Reset disks to non-RAID

Individual components of a RAID volume can be reset to non-RAID mode. This option is available in menu "Disk n" on page 145.

#### Information:

Deleting a RAID volume also deletes all of the data on the drive.

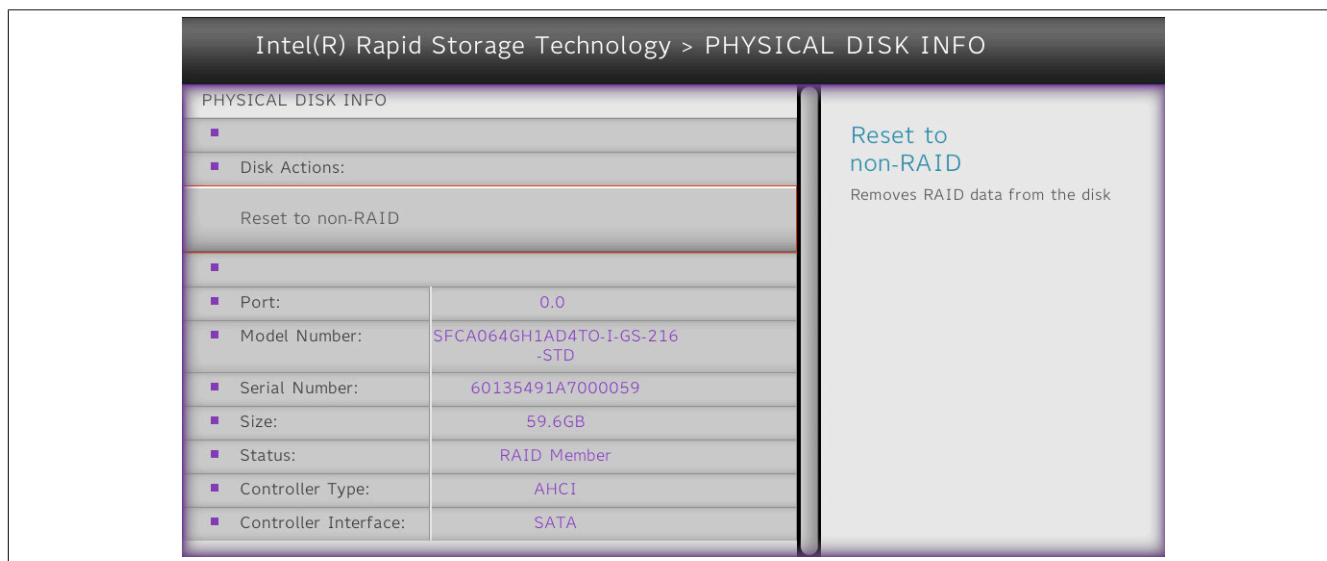

Figure 19: RAID volume reset

## 7.4 Operating systems

### 7.4.1 Windows 10 IoT Enterprise 2019 LTSC

#### 7.4.1.1 General information

Windows 10 IoT Enterprise 2019 LTSC is a special version of Windows 10 Enterprise for industrial use (Long-Term Servicing Channel) that provides a high level of protection for applications through additional lockdown functions.

#### Information:

For detailed information, see the user's manual of the operating system. This is available for download on the B&R website ([www.br-automation.com](http://www.br-automation.com)).

#### 7.4.1.2 Order data

Order number	Short description	Figure
	<b>Windows 10 IoT Enterprise 2019 LTSC</b>	
5SWW10.1000-MUL	Windows 10 IoT Enterprise 2019 LTSC: - 64-bit - Value - Multilingual - License - Only available with a new device	
5SWW10.1100-MUL	Windows 10 IoT Enterprise 2019 LTSC: - 64-bit - High End - Multilingual - License - Only available with a new device	

#### 7.4.1.3 Overview

Order number	5SWW10.1000-MUL	5SWW10.1100-MUL
<b>Operating system</b>		
Target systems	APC910, APC3100, PPC3100	
Industrial PC		
Processor	Celeron, Core i3, Core i5	Core i7, Xeon
Chipset	HM170, QM170, Kaby Lake-U	QM170, CM236, Kaby Lake-U
License class	Value	High End
Architecture	64-bit (UEFI boot)	
Language	Multilingual	
Minimum size of RAM	2 GB <sup>1)</sup>	
Minimum size of data storage medium	20 GB <sup>2)</sup>	

- 1) The specified memory size is a minimum requirement according to Microsoft. B&R recommends using 4 GB RAM or more for 64-bit operating systems.
- 2) The specified minimum size of the data storage medium does not take into account the memory requirements of additional language packages.

#### 7.4.1.4 Features

Windows 10 IoT Enterprise 2019 LTSC supports the following Microsoft features:

Features	Windows 10 IoT Enterprise 2019 LTSC
Range of functions in Windows 10 Enterprise	✓
Internet Explorer 11 (including Enterprise Mode)	✓
Windows Touch	✓
Multilingual support	With language packs (default: English)
Page file	Configurable (default: disabled by UWF)
Hibernate file	Configurable (default: disabled)
System restore	Configurable (default: disabled by UWF)
SuperFetch	
File indexing service	
Fast boot	
Defragmentation service	✓ (disabled when enabling the UWF)
<b>Additional lockdown features (excerpt)</b>	
Assigned access	Configurable
AppLocker	Configurable
Shell Launcher	Configurable
Unified Write Filter	✓
Keyboard Filter	Configurable

The following are some differences from standard Windows 10 Enterprise:

- Windows 10 IoT Enterprise 2019 LTSC does not include Cortana, the Microsoft Edge browser or the Microsoft Store.
- The LTSC version is based on build 17763 of Windows 10 and does not receive any feature updates.
- The version installed by B&R contains optimized settings for operation in an industrial environment.

These are described in detail in the **Windows 10 IoT Enterprise 2019 LTSC working guide**. This contains information about installing languages, enabling lockdown and other features.

**Information:**

These settings, as well as all features not included in the LTSC version, result in different behavior compared to a standard Windows 10 Enterprise installation.

**7.4.1.5 Installation**

B&R installs and activates Windows 10 IoT Enterprise 2019 LTSC on a suitable data storage medium. After the system has been switched on for the first time, it runs through the out-of-box experience (OOBE), which allows the user to make various settings (e.g. language, region, keyboard, computer name, username).

The operating system is now only installed in UEFI mode.

The data storage medium containing the Windows partition is formatted as a GUID Partition Table (GPT) file system in UEFI mode. For other drives, it is possible to use either the GPT or Master Boot Record (MBR) file format. A GPT drive can have up to 128 partitions.

**Notice!**

It is important to note that when installing in UEFI mode, the GPT file system must be supported by the software being used when backing up and restoring the installation.

**7.4.1.6 Drivers**

The operating system contains all drivers necessary for operation. If an older driver version is installed, the latest version can be downloaded and installed from the B&R website ([www.br-automation.com](http://www.br-automation.com)). It is important to ensure that "Unified Write Filter (UWF)" is disabled.

**Information:**

Necessary drivers must be downloaded from the B&R website, not from manufacturer websites.

### 7.4.1.7 Activation

Windows 10 IoT Enterprise 2019 LTSC must be activated like its predecessor version. This takes place at B&R. The activation status can be checked in the Control Panel:

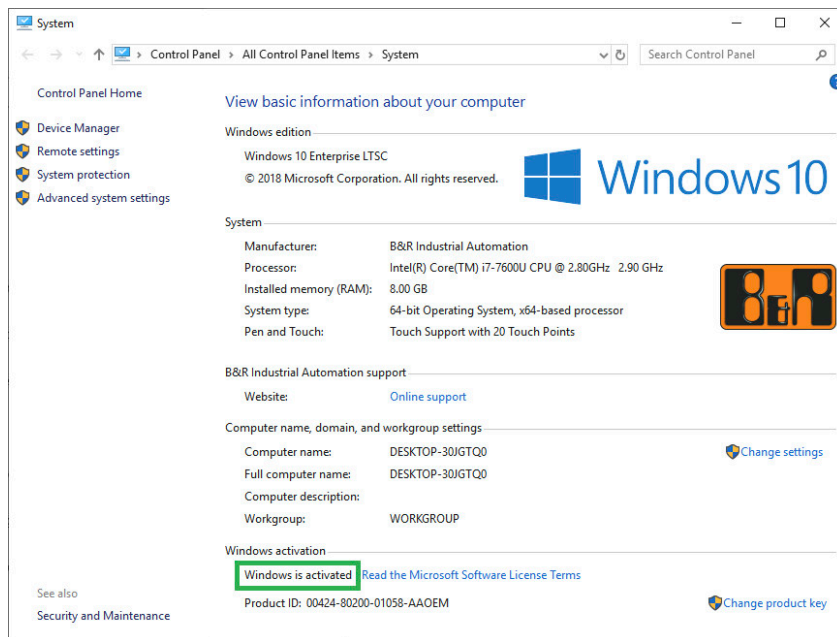

The activation carried out by B&R is supported by special B&R extensions in the operating system and is not lost when the hardware is changed (e.g. replacement of components in the event of repair) or when the system is reinstalled (Microsoft reserves the right to make technical changes without notice).

### 7.4.1.8 Supported display resolutions

Windows requires SVGA resolution (800 x 600) or higher per Microsoft requirements to activate full operation of the Windows interface (e.g. with system dialog boxes). A lower resolution can be selected for applications.

## 7.4.2 Windows 10 IoT Enterprise 2016 LTSB

### 7.4.2.1 General information

Windows 10 IoT Enterprise 2016 LTSB is a version of Windows 10 Enterprise specifically developed for use in industrial applications (Long-Term Servicing Branch).

#### Information:

For detailed information, see the user's manual of the operating system. This is available for download on the B&R website ([www.br-automation.com](http://www.br-automation.com)).

### 7.4.2.2 Order data

Order number	Short description	Figure
	<b>Windows 10 IoT Enterprise 2016 LTSB</b>	
5SWW10.0653-MUL	Windows 10 IoT Enterprise 2016 LTSB - 64-bit - Value - Multilingual - APC3100 Kaby Lake (UEFI boot) - CPU Celeron/Core i3/Core i5 - License - Only available with a new device	
5SWW10.0753-MUL	Windows 10 IoT Enterprise 2016 LTSB - 64-bit - High End - Multilingual - APC3100 Kaby Lake (UEFI boot) - CPU Core i7 - License - Only available with a new device	
5SWW10.0655-MUL	Windows 10 IoT Enterprise 2016 LTSB - 64-bit - Value - Multilingual - APC3100 Kaby Lake (Legacy BIOS boot) - CPU Celeron/Core i3/Core i5 - License - Only available with a new device	
5SWW10.0755-MUL	Windows 10 IoT Enterprise 2016 LTSB - 64-bit - High End - Multilingual - APC3100 Kaby Lake (Legacy BIOS boot) - CPU Core i7 - License - Only available with a new device	
	<b>Optional accessories</b>	
	<b>Windows 10 IoT Enterprise 2016 LTSB</b>	
5SWW10.0800-MUL	Windows 10 IoT Enterprise 2016 LTSB - 64-bit - Language Pack DVD	

### 7.4.2.3 Overview

Order number	5SWW10.0653-MUL	5SWW10.0753-MUL	5SWW10.0655-MUL	5SWW10.0755-MUL
<b>Operating system</b>				
Target systems				
Industrial PC	APC3100			
Processor	Celeron, Core i3 and i5	Core i7	Celeron, Core i3 and i5	Core i7
Chipset	Kaby Lake			
Edition	Value	High End	Value	High End
Architecture	64-bit (UEFI boot)		64-bit (legacy BIOS boot)	
Language	Multilingual			
Minimum size of RAM	2 GB <sup>1)</sup>			
Minimum size of data storage medium	20 GB <sup>2)</sup>			

1) The specified memory size is a minimum requirement according to Microsoft. B&R recommends using 4 GB RAM or more for 64-bit operating systems.

2) The specified minimum size of the data storage medium does not take into account the memory requirements of additional language packages.

### 7.4.2.4 Features

The feature list shows the most important device functions in Windows 10 IoT Enterprise 2016 LTSB.

Function	Windows 10 IoT Enterprise 2016 LTSB
Range of functions in Windows 10 Enterprise	✓
Internet Explorer 11 including Enterprise Mode	✓
Multi-touch support	✓
Multilingual support	Can be installed via Language Pack DVDs (default language is English)
Page file	Configurable (disabled by default in the image by the UWF)
Hibernate file	Configurable (disabled by default in the image)
System restore	Configurable (disabled by default in the image by the UWF)
SuperFetch	Configurable (disabled by default in the image by the UWF)
File indexing service	Configurable (disabled by default in the image by the UWF)
Fast boot	Configurable (disabled by default in the image by the UWF)
Defragmentation service	✓ (Disabled when enabling the UWF)
<b>Additional embedded lockdown functions</b>	
Assigned access	Configurable
AppLocker	Configurable
Shell Launcher	Configurable
Unified Write Filter	✓
Keyboard Filter	Configurable

Table 139: Device functions in Windows 10 IoT Enterprise 2016 LTSB

### 7.4.2.5 Installation

Windows 10 IoT Enterprise 2016 LTSB is preinstalled by B&R on a suitable data storage medium (64-bit: at least 20 GB). After the system has been switched on for the first time, it runs through the out-of-box experience (OOBE), which allows different settings to be made (e.g. language, region, keyboard, computer name, username).

Windows 10 IoT Enterprise 2016 LTSB can be installed in UEFI or Legacy BIOS mode. In UEFI mode, the data storage medium containing the Windows partition is formatted with a GUID Partition Table (GPT) file system. For other drives, it is possible to use either the GPT or Master Boot Record (MBR) file format. A GPT drive can have up to 128 partitions.

When backing up and restoring the installation, note that the GPT file system must be supported by the software used.

### 7.4.2.6 Drivers

The operating system contains all drivers necessary for operation. If an older driver version is installed, the latest version can be downloaded and installed from the B&R website ([www.br-automation.com](http://www.br-automation.com)). It is important to ensure that "Unified Write Filter (UWF)" is disabled.

## Information:

**Necessary drivers must be downloaded from the B&R website, not from manufacturer websites.**

### 7.4.2.7 Activation

Windows 10 IoT Enterprise 2016 LTSB must be activated like its predecessor Windows 10 IoT Enterprise 2015 LTSB. This takes place at B&R.

The activation status can be checked in the Control Panel:

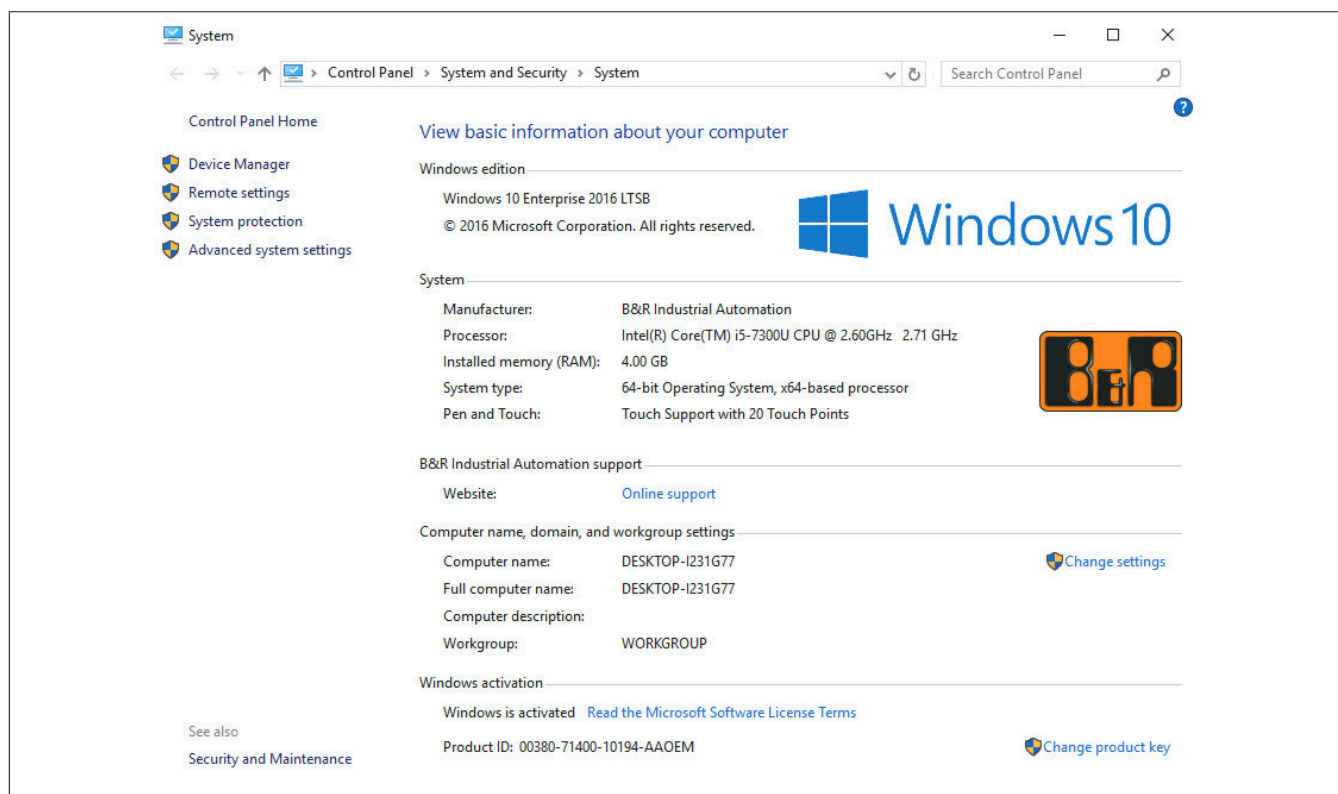

Figure 20: System properties

Activation carried out by B&R is supported by special B&R extensions in the operating system and theoretically not lost when the hardware is changed (e.g. replacement of components in the event of repair) or when the system is reinstalled, unlike Windows 10 IoT Enterprise 2015 LTSB (Microsoft reserves the right to make technical changes without notice).

## Information:

**It is not required to enter a product key for activation.**



#### 7.4.2.8 Characteristics, limitations

- Unlike standard Windows 10 Enterprise, Windows 10 IoT Enterprise 2016 LTSC does not include Cortana, the Microsoft Edge browser or the Microsoft Store, for example.
- The LTSC version is based on build 14393 of Windows 10 and does not receive any feature updates.

The version installed by B&R contains optimized settings for operation in an industrial environment. These are described in detail in a manual for Windows 10 IoT Enterprise 2016 LTSC. This can be downloaded at no cost from the Downloads section of the B&R website ([www.br-automation.com](http://www.br-automation.com)) (login required).

#### **Information:**

**These settings as well as the features not included in the LTSC version cause different behavior compared to a standard Windows 10 Enterprise installation.**

#### 7.4.2.9 Supported display resolutions

Windows requires SVGA resolution (800 x 600) or higher per Microsoft requirements to activate full operation of the Windows interface (e.g. with system dialog boxes). A lower resolution can be selected for applications.

## 7.4.3 B&R Linux 10 (GNU/Linux)

### 7.4.3.1 General information

B&R supports Linux in the form of modified images based on Debian GNU / Linux 10 (codename "buster").

With B&R Linux, B&R offers a variant of Debian optimized for B&R industrial PCs that already includes all B&R-specific modifications and offers the broadest possible basis for various applications.

Reasons for Debian:

- High stability
- Large package selection
- Wide distribution of Debian and various derivatives (e.g. Ubuntu, Linux Mint)

For additional information, see the Debian website (<https://www.debian.org/>).

### Information:

For detailed information, see the user's manual of the operating system. This is available for download on the B&R website ([www.br-automation.com](http://www.br-automation.com)).

### 7.4.3.2 Order data

Order number	Short description	Figure
	<b>B&amp;R Linux 10</b>	
5SWLIN.0853-MUL	B&R Linux 10 - 64-bit - Multilingual - APC3100 Kaby Lake (UEFI boot) - Installation - Only available with a new device	
	<b>Optional accessories</b>	
	<b>CFast cards</b>	
5CFAST.016G-00	CFast 16 GB SLC	
5CFAST.032G-00	CFast 32 GB SLC	
5CFAST.032G-10	CFast 32 GB MLC	
5CFAST.064G-10	CFast 64 GB MLC	
5CFAST.128G-10	CFast 128 GB MLC	
5CFAST.256G-10	CFast 256 GB MLC	
5CFAST.8192-00	CFast 8 GB SLC	

### 7.4.3.3 Overview

Order number	5SWLIN.0853-MUL
<b>Operating system</b>	
Target systems	
Industrial PC	APC3100
Chipset	Kaby Lake
Architecture	64-bit (UEFI boot)
Language	Multilingual
Minimum size of RAM	2 GB
Minimum size of data storage medium	8 GB

### 7.4.3.4 Features

B&R Linux 10 contains a selection of predefined software package groups. Additional packages can be installed later with an existing Internet connection.

Appropriate modifications have been made and certain features provided using custom packages in order to use Debian on B&R Automation Panels and Panel PCs. Most of these packages are already included in B&R Linux and/or available for download on the B&R website ([www.br-automation.com](http://www.br-automation.com)).

### 7.4.3.5 Installation

B&R Linux 10 is preinstalled at B&R on the desired data storage medium (e.g. CFast card).

### 7.4.3.6 Drivers

The operating system contains all drivers necessary for operation.

The current version of B&R-specific drivers can be downloaded and installed from the B&R website ([www.br-automation.com](http://www.br-automation.com)).

## 7.4.4 B&R Linux 9 (GNU/Linux)

### 7.4.4.1 General information

B&R supports Linux in the form of modified images based on Debian GNU / Linux 9 ("Stretch").

With B&R Linux, B&R offers a variant of Debian optimized for B&R industrial PCs that already includes all B&R-specific modifications and offers the broadest possible basis for various applications.

Reasons for Debian:

- High stability
- Large package selection
- Wide distribution of Debian and various derivatives (e.g. Ubuntu, Linux Mint)

For additional information, see the Debian website (<https://www.debian.org/>).

### Information:

For detailed information, see the user's manual of the operating system. This is available for download on the B&R website ([www.br-automation.com](http://www.br-automation.com)).

### 7.4.4.2 Order data

Order number	Short description	Figure
	<b>B&amp;R Linux 9</b>	
5SWLIN.0753-MUL	B&R Linux 9 - 64-bit - Multilingual - APC3100 Kaby Lake (UEFI boot) - Installation - Only available with a new device	
5SWLIN.0755-MUL	B&R Linux 9 - 64-bit - Multilingual - APC3100 Kaby Lake (Legacy boot) - Installation - Only available with a new device	
	<b>Optional accessories</b>	
	<b>CFast cards</b>	
5CFAST.016G-00	CFast 16 GB SLC	
5CFAST.032G-00	CFast 32 GB SLC	
5CFAST.032G-10	CFast 32 GB MLC	
5CFAST.064G-10	CFast 64 GB MLC	
5CFAST.128G-10	CFast 128 GB MLC	
5CFAST.256G-10	CFast 256 GB MLC	
5CFAST.4096-00	CFast 4 GB SLC	
5CFAST.8192-00	CFast 8 GB SLC	

### 7.4.4.3 Overview

Order number	5SWLIN.0753-MUL	5SWLIN.0755-MUL
<b>Operating system</b>		
Target systems		
Industrial PC		APC3100
Chipset		Kaby Lake
Architecture	64-bit (UEFI boot)	64-bit (Legacy boot)
Language		Multilingual
Minimum size of RAM		4 GB
Minimum size of data storage medium		4 GB

### 7.4.4.4 Features

- LXDE desktop
- Touch screen support
- MTCX driver
- ADI library
- Tool for right-click support via touch screen
- Virtual keyboard

Detailed instructions about B&R Linux 9 for B&R devices can be downloaded from the Downloads section of the B&R website ([www.br-automation.com](http://www.br-automation.com)).

### 7.4.4.5 Installation

B&R Linux 9 is preinstalled at B&R on the desired data storage medium (e. g. CFast card).

#### **7.4.4.6 Drivers**

The operating system contains all drivers necessary for operation.

The current version of B&R-specific drivers can be downloaded and installed from the B&R website ([www.br-automation.com](http://www.br-automation.com)).

## 7.5 Automation software

### 7.5.1 Licensing

B&R Automation Runtime software components (e.g. Automation Runtime, B&R Hypervisor, mapp Technology) require a license.

It is possible to choose between the following licensing types:

#### Technology Guarding (TG)

Technology Guarding is license protection used for individual software components. The *Technology Guard* (hardware dongle) serves as the license container; this is connected to an available USB interface on the target system.

#### Information:

**Licensing via TG is required for Automation Studio V4.1 or later and Automation Runtime V4.08 or later. No TG is necessary in earlier versions.**

#### Terms and conditions (TC)

No *Technology Guard* is necessary; licensing takes place via a license agreement. Licenses are supplied with the sales receipt. The user is responsible for complying with the license conditions. B&R is protected by the terms of the EULA.

#### Information:

**Licensing via TC is possible for Automation Studio V4.9 or later as well as Automation Runtime V4.90 or later.**

For detailed information about licensing, see Automation Help ([Automation software / Licensing](#)).

### 7.5.2 Order data

#### Hardware-based licensing (Technology Guard)

Order number	Short description	Figure
	<b>Technology Guard</b>	
0TG1000.01	Technology Guard (MSD)	
0TG1000.02	Technology Guard (HID)	
0TGF016.01	Technology Guard (MSD) with integrated flash drive, 16 GB (MLC)	
1TG4601.06-5	Automation Runtime Embedded, TG license	
1TG4601.06-T	Automation Runtime Embedded Terminal TG license	
1TG4600.10-5	Automation Runtime Windows TG license	
1TG4700.00	B&R Hypervisor	

#### Contract-based licensing (terms and conditions)

Order number	Short description	Figure
	<b>Runtime</b>	
1TC4601.06-5	License for Automation Runtime Embedded (TC). One license per target system is required.	
	<b>Hypervisor</b>	
1TC4700.00	License for B&R Hypervisor (TC). One license per target system is required.	

#### 7.5.3.1 Support

The following table provides an overview of which Automation Runtime software components are supported by the device.

Target system	B&R Hypervisor	ARemb	ARemb Terminal (TG only)	ARwin <sup>1)</sup> (TG only)
APC3100	Yes	Yes	No	Yes

1) ARwin is no longer supported starting with Automation Runtime V4.6.

## 7.5.4 Automation Runtime

### 7.5.4.1 General information

The real-time operating system Automation Runtime is an integral part of Automation Studio. This real-time operating system forms the software core for running applications on a target system.

- Guarantees the highest possible performance of the hardware being used
- Runs on all B&R target systems
- Makes the application hardware-independent
- Easy portability of applications between B&R target systems
- Guaranteed determinism through cyclic system
- Configurable jitter tolerance in all task classes
- Support for all relevant programming languages, such as IEC 61131-3 languages and C
- Rich function library per IEC 61131-3 as well as the extended B&R automation library
- Integrated in Automation NET. Access to all networks and bus systems via function calls or by configuration in Automation Studio

B&R Automation Runtime is fully embedded in the corresponding target system (hardware on which Automation Runtime is installed). It thus enables application programs to access I/O systems (also via the fieldbus) and other devices such as interfaces and networks.

### 7.5.4.2 Minimum versions

#### 7.5.4.2.1 Automation Runtime Embedded (ARemb)

##### System requirements

The following software versions (or higher) are required to operate Automation Runtime Embedded on an Automation PC 3100:

- ARemb upgrade AR E4.34
- Automation Studio V4.3.4
- Visual Components Runtime (VC) V4.34
- Technology Guard

##### Information:

In order to use Automation Runtime Embedded (ARemb), BIOS setting *Advanced - OEM features - Realtime environment* must be set to *Enabled*.

#### 7.5.4.2.2 Automation Runtime Windows (ARwin)

##### System requirements

The following software versions (or higher) are required to operate Automation Runtime Windows on an Automation PC 3100:

- ARwin Upgrade AR E4.34
- Automation Studio V4.3.4
- Technology Guard

##### Information:

To operate Automation Runtime Windows (ARwin), parameter *Advanced - OEM features - Realtime environment* must be set to *Enabled* in BIOS and parameter *Boot - EFI device first* must be set to *Disabled*.

##### Information:

ARwin is no longer supported starting with Automation Runtime V4.6.

##### Information:

For detailed information, see Automation Help or the B&R website ([www.br-automation.com](http://www.br-automation.com)).

### 7.5.4.3 Information about operation with Automation Runtime

#### Information:

The specified **thermal design power (TDP)** of the CPU may be exceeded if the graphics load and CPU utilization are high at the same time. In real-time applications, this can result in increased jitter and/or higher cycle times.

If the TDP is exceeded, internal protection mechanisms of the CPU begin limiting the load to the limit of the TDP. This means that either the CPU frequency or the graphic frequency (GPU) will be reduced/controlled. In real-time applications, this can result in increased jitter and/or higher cycle times.

This behavior can be influenced by settings in BIOS. The maximum CPU frequency can be set in BIOS under *Advanced - CPU configuration* using option *CPU flex ratio override*. The number of cores used can be set using option *Active processor cores*.

In addition, the maximum frequency of the GPU (Gfx) can be limited in BIOS under **Advanced - Power & Performance - GT power management control** with option *Maximum GT frequency*.

Limiting the CPU and/or GPU frequency reduces power consumption and prevents the TDP from being exceeded.

The optimal settings for real-time operation depend on several factors:

#### 7.5.4.3.1 CPU variant used:

- If CPU C-3965U is used, no further action (BIOS settings) are necessary. However, B&R still recommends using single-core operation for pure ARemb operation (*Active processor cores* limited to 1).
- If CPU i3-7100U, i5-7300U or i7-7600U is used, see "ARemb, ARwin or B&R Hypervisor mode".

#### 7.5.4.3.2 ARemb , ARwin or B&R Hypervisor mode:

- For pure ARemb operation, single-core operation (*Active processor cores* = 1) must be used and the GPU frequency limited to an average value, see "Typical use cases for ARemb".
- For ARwin or B&R Hypervisor mode, see "Typical use cases for ARwin or B&R Hypervisor".

#### 7.5.4.3.3 Typical use cases for ARemb:

The following configuration examples are intended to represent typical use cases.	
xPC3100 C-3965U	No limitation of CPU and/or GPU frequency necessary. Operation with max. CPU and Gfx frequency is possible. However, B&R recommends single-core operation ( <i>Active processor cores</i> = 1).
xPC3100 i3-7100U	Single-core operation with 2400 MHz CPU frequency and 600 MHz Gfx frequency
xPC3100 i5-7300U	Single-core operation with 2600 MHz CPU frequency and 600 MHz Gfx frequency
xPC3100 i7-7600U	Single-core operation with 2800 MHz CPU frequency and 600 MHz Gfx frequency

#### 7.5.4.3.4 Typical use cases for ARwin or B&R Hypervisor:

The following configuration examples are intended to represent typical use cases.	
xPC3100 C-3965U	No limitation of CPU and/or GPU frequency necessary. Operation with max. CPU and Gfx frequency is possible.
xPC3100 i3-7100U	Single-core operation with 1400 MHz CPU frequency and 800 MHz Gfx frequency
	Single-core operation with 2000 MHz CPU frequency and 450 MHz Gfx frequency
xPC3100 i5-7300U	Single-core operation with 1600 MHz CPU frequency and 800 MHz Gfx frequency
	Single-core operation with 2100 MHz CPU frequency and 450 MHz Gfx frequency
xPC3100 i7-7600U	Single-core operation with 1600 MHz CPU frequency and 800 MHz Gfx frequency
	Single-core operation with 2100 MHz CPU frequency and 450 MHz Gfx frequency

## 7.5.5 B&R Hypervisor

B&R Hypervisor allows multiple operating systems to operate simultaneously on a single device. The operating systems can communicate with each other via a virtual network.

### Intelligent distribution of CPU resources

B&R Hypervisor allows Windows or Linux to run simultaneously with Automation Runtime. This makes it possible to combine a controller and HMI PC in one device. With B&R Hypervisor, an industrial PC can also be used as an edge controller. This serves as a controller and simultaneously transmits pre-processed data to higher-level systems in the cloud via OPC UA.



### Virtual network

The hypervisor provides a virtual network connection that allows applications to exchange data between operating systems. Similar to an ordinary Ethernet interface, standard network protocols are used. In place of a cable, there is a reserved memory area that is not allocated to either operating system.

### Maximum flexibility

The user configures the hypervisor and allocates hardware resources in the B&R Automation Studio software development environment. The system configurations are determined individually. This makes the assignment of resources to the respective operating system flexible. Whereas previous simultaneous solutions were tailored to a specific Windows version, B&R Hypervisor is completely independent of the version of the operating systems used.

### System requirements

The following minimum software versions are required to operate B&R Hypervisor on the Automation PC 3100:

- ARemb upgrade AR B4.45
- Automation Studio V4.4.5
- APC3100 BIOS V1.12
- APC3100 MTCX V4.19

### Information:

The following settings must be made to operate B&R Hypervisor:

- **Advanced - OEM features - Realtime environment** must be enabled.
- **Advanced - OEM features - Hypervisor environment** must be enabled.
- **Boot - EFI device first:**

#### Legacy boot

- **Boot - EFI device first** must be disabled.

#### UEFI boot

- **Boot - EFI device first** must be enabled (default).

### Information:

For additional important information regarding operation of Automation Runtime, see "[Information about operation with Automation Runtime](#)" on page 207.

### Information:

For detailed information, see Automation Help or the B&R website ([www.br-automation.com](http://www.br-automation.com)).



### 7.5.6 mapp Technology



mapp is revolutionizing the creation of software for industrial machinery and equipment. mapp components – mapps for short – are as easy to use as smartphone apps. Rather than write lines and lines of code to build a user management system, alarm system or motion control sequence from the ground up, developers of machine software simply configure the ready-made mapps with a few clicks of the mouse. Complex algorithms are easy to master. Programmers can focus entirely on the machine process.

**Information:**

For detailed information, see Automation Help or the B&R website ([www.br-automation.com](http://www.br-automation.com)).

## 7.6 Automation Device Interface (ADI)

The Automation Device Interface (ADI) enables access to specific functions of B&R devices.

### 7.6.1 ADI driver

#### 7.6.1.1 Installation

The ADI driver is included in most B&R Windows operating systems or can be installed on request.

The ADI driver (also includes the ADI Control Center) and user documentation can be downloaded at no cost from the Downloads section of the B&R website ([www.br-automation.com](http://www.br-automation.com)). If a more recent version is available, it can be installed later.

#### Information:

The *Write filter* must be disabled during installation.

#### 7.6.1.2 ADI Control Center

The settings of B&R devices can be read out and changed in Windows using the ADI Control Center in the Control Panel. The figure shown is a symbolic image; the representation may vary depending on the device.

#### Information:

The displayed temperature and voltage values (e.g. CPU temperature, core voltage, battery voltage) represent uncalibrated information values. No conclusions about possible alarms or hardware malfunctions can be drawn from this. The hardware components used have automatic diagnostic functions in the event of error.

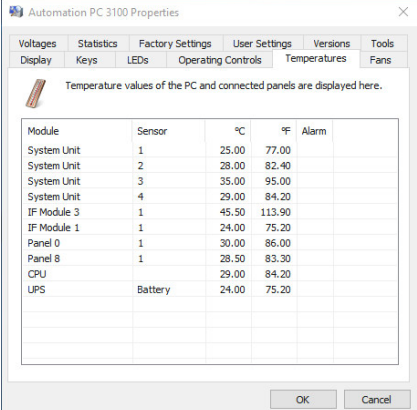

Automation PC 3100 Properties

Voltages Statistics Factory Settings User Settings Versions Tools  
Display Keys LEDs Operating Controls Temperatures Fans

Temperature values of the PC and connected panels are displayed here.

Module	Sensor	°C	°F	Alarm
System Unit	1	25.00	77.00	
System Unit	2	28.00	82.40	
System Unit	3	35.00	95.00	
System Unit	4	29.00	84.20	
IF Module 3	1	45.50	113.90	
IF Module 1	1	24.00	75.20	
Panel 0	1	30.00	86.00	
Panel 8	1	28.50	83.30	
CPU		29.00	84.20	
UPS	Battery	24.00	75.20	

OK Cancel

Figure 21: ADI Control Center screenshots - Examples

#### 7.6.1.2.1 Functions

The ADI Control Center offers the following functions, for example:

- Changing display-specific parameters
- Reading out device-specific keys
- Updating the key configuration
- Testing keys or device-specific LEDs of a membrane keypad
- Reading out or calibrating control devices (e.g. key switch, handwheel, joystick, potentiometer)
- Reading out temperatures, fan speeds, switch positions and statistical data
- Reading out operating hours (power-on hours)
- Reading user settings and factory settings
- Reading out software versions
- Updating and backing up BIOS and firmware
- Creating reports for the current system (support)
- Setting the SDL equalizer value for the SDL cable adjustment
- Changing the user serial ID

For a detailed description, see the user documentation for the ADI driver.

#### Information:

The functions available in the ADI Control Center depend on the device family.

## 7.6.2 ADI Development Kit

This software allows *ADI* functions to be accessed from Windows applications created with Microsoft Visual Studio, for example:

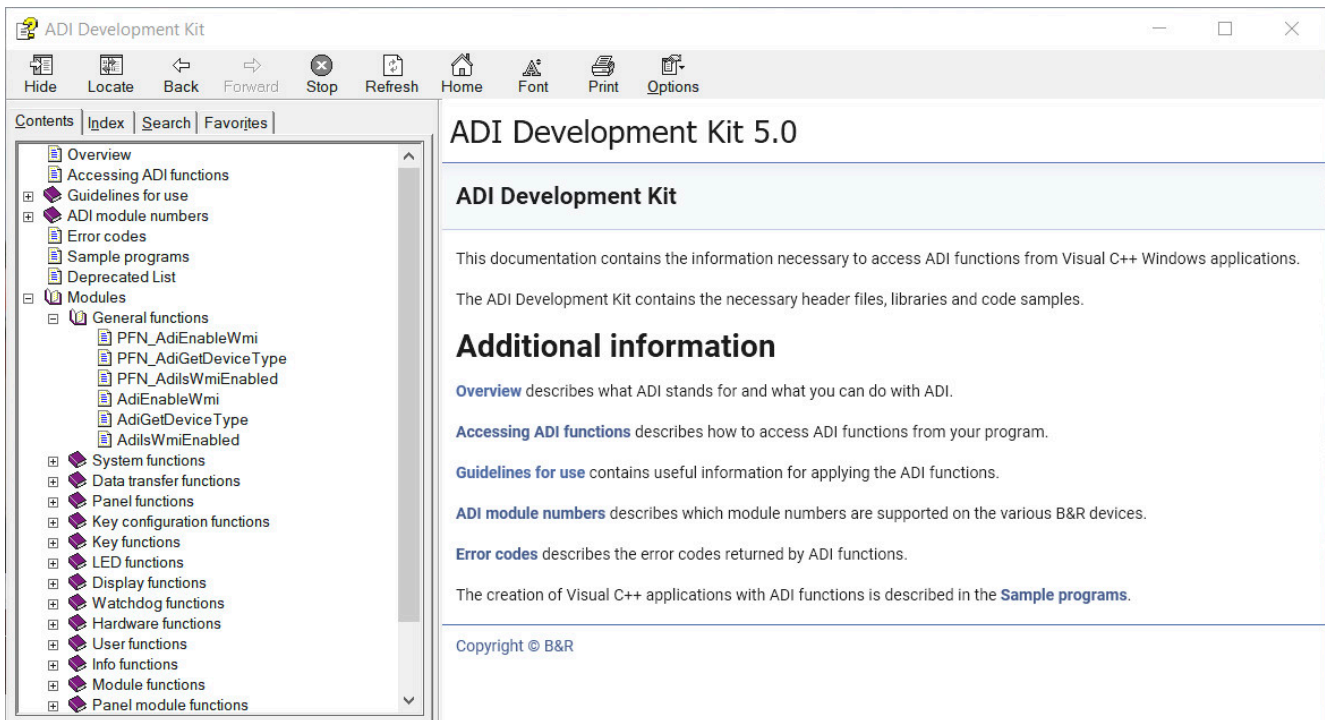

Figure 22: ADI Development Kit screenshots (version 3.70)

### Features:

- Header files and import libraries
- Help files
- Example projects
- ADI DLL: For testing applications if no ADI driver is installed.

The appropriate ADI driver must be installed for the device. The ADI driver is already included in B&R images of embedded operating systems.

For a detailed description of how to use ADI functions, see Automation Help.

The ADI Development Kit can be downloaded at no cost from the Downloads section of the B&R website ([www.br-automation.com](http://www.br-automation.com)).

### 7.6.3 ADI .NET SDK

This software allows *ADI* functions to be accessed from .NET applications created with Microsoft Visual Studio.

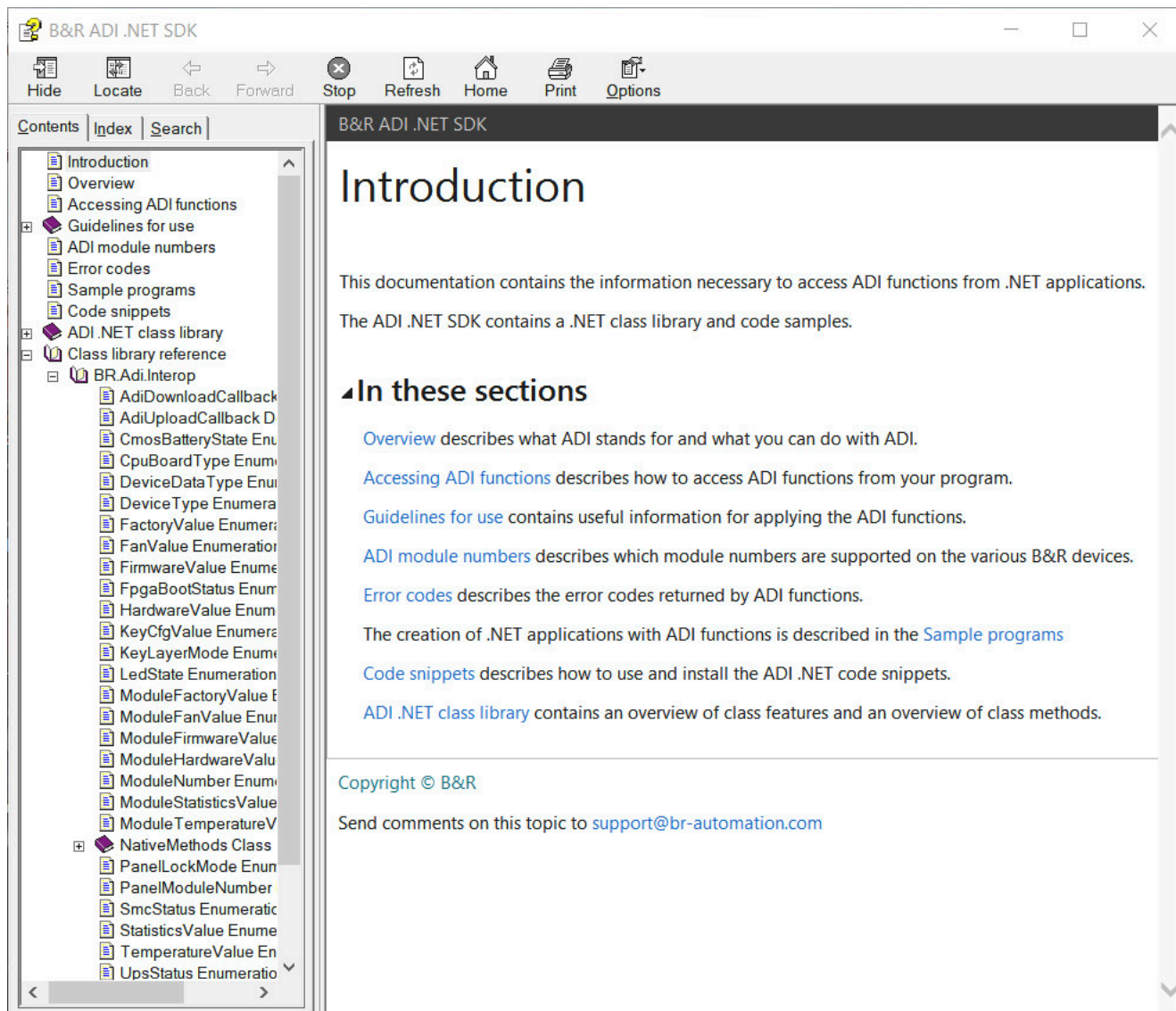

Figure 23: ADI .NET SDK screenshots (version 2.10)

#### Features:

- ADI .NET class library
- Help files (in English)
- Sample projects and code snippets
- ADI DLL: For testing applications if no ADI driver is installed.

The appropriate ADI driver must be installed for the device. The ADI driver is already included in B&R images of embedded operating systems.

For a detailed description of how to use ADI functions, see Automation Help.

The ADI .NET SDK can be downloaded at no cost from the Downloads section of the B&R website ([www.br-automation.com](http://www.br-automation.com)).

#### 7.6.4 ADI OPC UA Server

ADI OPC UA Server provides the functions and information about Automation Device Interface (ADI) as OPC UA variables.

OPC UA stands for **O**pen **P**latform **C**ommunications **U**nified **A**rchitecture and is an international standard for secure, reliable, manufacturer and platform-independent information exchange in industrial communication.

OPC UA is based on the client-server principle and, in the case of ADI OPC UA Server, enables temperatures and device information to be read from B&R devices, for example.

Additional information is available on the OPC Foundation ([www.opcfoundation.org](http://www.opcfoundation.org)) website, for example.

The ADI OPC UA Server and user documentation can be downloaded at no cost from the Downloads section of the B&R website ([www.br-automation.com](http://www.br-automation.com)).

## 7.7 Key Editor

A frequently occurring requirement for panels is adapting function keys and LEDs to the application software. With the Key Editor, individual adaptation to the application is possible quickly and easily.

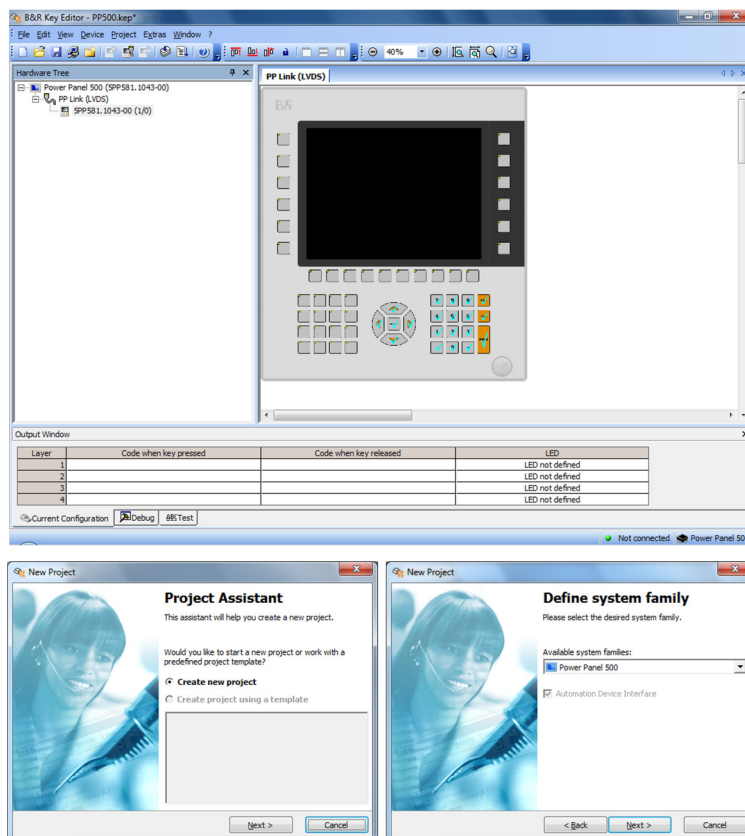

Figure 24: B&R Key Editor screenshots (version 3.50)

### Features:

- Configuration of normal keys like on a keyboard (A, B, C, etc.)
- Keyboard shortcuts (CTRL+C, SHIFT+DEL, etc.) on one key
- Special key functions (change brightness, etc.)
- Assignment of LED functions (HDD access, power, etc.)
- 4 assignments possible per key (using layers)
- Configuration of the panel lock time when connecting several Automation Panel devices to Automation PCs and Panel PCs

For detailed instructions about configuring keys and LEDs and installing the key configuration on the target system, see the help documentation for the Key Editor. The Key Editor and help documentation can be downloaded at no cost from the Downloads section of the B&R website ([www.br-automation.com](http://www.br-automation.com)).

## 7.8 KCF Editor

The KCF Editor can be used as a simple alternative to the Key Editor. It can also be used to adapt function keys and LEDs to the application software. In contrast to the Key Editor, operation does not take place using a graphical representation of the device, but via a simple Windows dialog box. The KCF Editor can therefore also be used for devices that are not yet supported in the Key Editor. The KCF Editor is a "portable" application and can be started directly from a USB flash drive without installation on the target device, for example.

An installed ADI driver is required for the full range of functions.

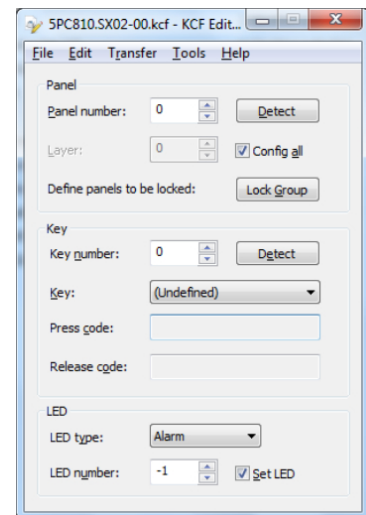

### Features:

- Configuration of normal keys like on a keyboard (A, B, C, etc.)
- Special key functions (change brightness, etc.)
- Assignment of LED functions (HDD access, power, etc.)
- 4 assignments possible per key (using layers)
- Configuration of the panel lock time when connecting several Automation Panel devices to B&R PCs.
- Export and import of the configuration (via INI files)
- Save configuration as report (text file)

If the KCF Editor is running on the target device and the ADI driver is installed, the following additional features are available:

- Panel and key detection
- LED test
- Download/Upload the configuration

For detailed instructions about configuring keys and LEDs and installing the key configuration on the target system, see the user documentation for the KCF editor. The KCF editor and user documentation can be downloaded at no cost from the Downloads section of the B&R website ([www.br-automation.com](http://www.br-automation.com)).

## 7.9 HMI Service Center

### 7.9.1 General information

The HMI Service Center is software for testing B&R industrial PCs and Automation Panels. Testing covers different categories such as COM, network and SRAM.

The test system consists of a USB flash drive with installed Windows PE operating system and the HMI Service Center.

For details about the HMI Service Center, see the HMI Service Center user's manual. This can be downloaded at no cost from the B&R website ([www.br-automation.com](http://www.br-automation.com)).

### 7.9.2 Order data

Order number	Short description	Figure
	<b>Accessories</b>	
5SWUT1.0001-000	HMI Service Center USB flash drive - Hardware diagnostic software - For APC910/PPC900 - For PPC1200 - For APC2100/PPC2100 - For APC2200/PPC2200 - For APC3100/PPC3100 - For APC mobile - For AP800/AP900 - For AP9x3/AP9xD - For AP1000/AP5000	

The following limitations regarding supported hardware revisions must be observed:

Devices	Starting with D0	Up to E0	Starting with E0
Automation Panel 1000	•		
Automation Panel 5000	•		
Automation PC 3100	•		
Automation PC 3100 mobile			•
Automation PC 2200	•		
Automation PC 810		•	
Automation PC 511		•	
Automation PC 510		•	
Panel PC 3100	•		
Panel PC 2200	•		
Panel PC 1200			•
Panel PC 800		•	
Power Panel 500		•	



## 8 Maintenance

The following chapter describes the maintenance work that can be carried out by a qualified and trained end user.

### Information:

Only components approved by B&R are permitted to be used for maintenance work.

### 8.1 Changing the battery

#### Warning!

The battery is only permitted to be replaced with a CR2477N battery. The use of any other battery may present a risk of fire or explosion.

The battery can explode if handled improperly. Do not recharge, disassemble or dispose of the battery in fire.

The lithium battery ensures the retention of the internal real-time clock (RTC) and CMOS data.

The following lithium replacement batteries are available: 4A0006.00-000 (1 pc.) and 0AC201.91 (4 pcs.).

Note the following when changing the battery:

- The product design allows the battery to be changed when the PLC is in a voltage-free state as well as when the B&R device is switched on. In some countries, changing under operating voltage is not permitted, however; local regulations must be observed!
- The battery is only permitted to be changed by qualified personnel.
- When changing the battery in a voltage-free state, any BIOS settings made are retained (stored in voltage-safe EEPROM). The date and time must be set again since this data is lost during the change.

#### 8.1.1 Changing the battery

1. Disconnect the power supply cable to the B&R industrial PC (disconnect the power cable).
2. Carry out electrostatic discharge on the housing or at the ground connection.
3. Remove the battery adapter of the device (protected against reverse polarity).

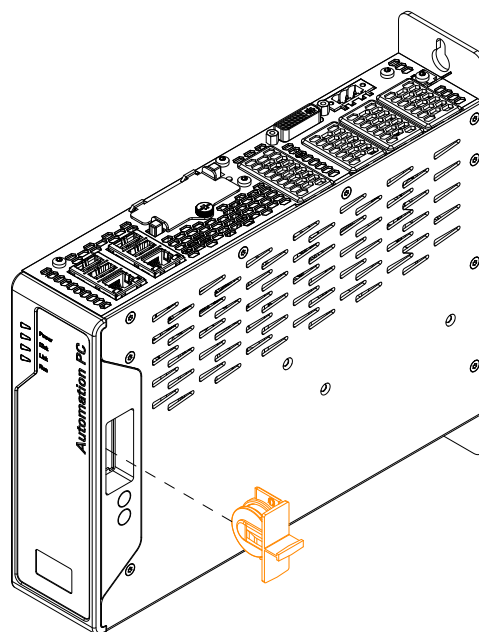

4. Remove the battery from the adapter and replace it.

**Note:**

The battery is not permitted to be held by its edges. Insulated tweezers may also be used to insert the battery.

When reinserting, pay attention to the polarity. The positive terminal is marked on the adapter; this must match the positive terminal of the battery.

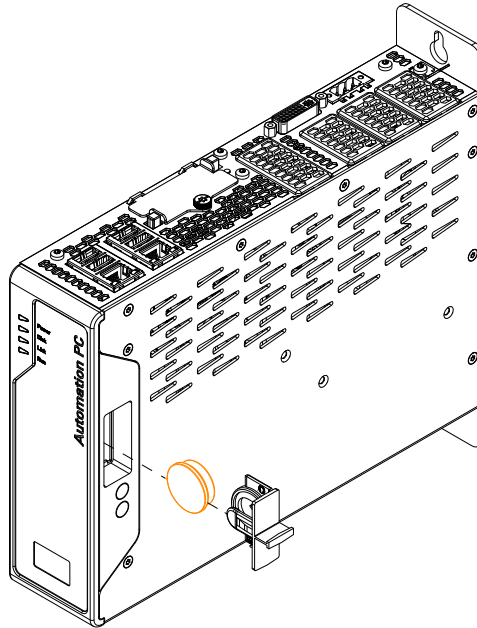
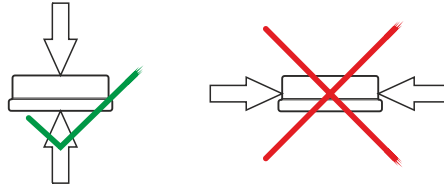

5. Insert the battery adapter back into the device.
6. Reconnect the power supply to the B&R industrial PC (connect the power connector).
7. Set the date and time in BIOS again.

**Warning!**

Lithium batteries are hazardous waste! Used batteries must be disposed of in accordance with local regulations.

## 8.2 Replacing CFast cards

### Caution!

The CFast card is only permitted to be replaced in a voltage-free state.

Improper handling of the ejector lever (e.g. applying a large amount of force) can result in a defect in the ejector mechanism.

1. Disconnect the power supply cable to the B&R industrial PC (disconnect the power cable).
2. Loosen the Torx screw (T10) of the cover plate and remove the cover plate.

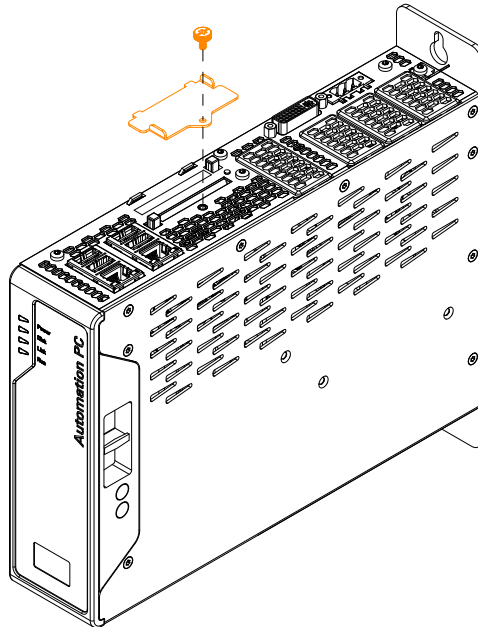

3. Press the ejector next to the card slot. The CFast card is ejected and can be replaced.

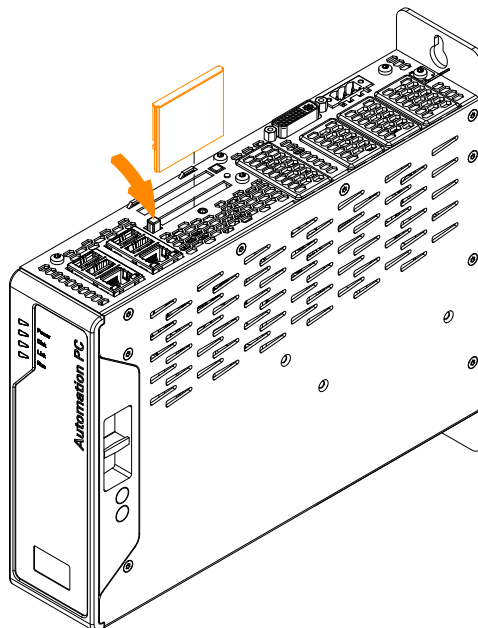

4. After replacing, re-secure the cover of the CFast card slot. The max. tightening torque of the screw is 0.55 Nm.

## 8.3 Installing the interface option and DDR4 SDRAM

### Caution!

Interface options or DDR4 main memory modules are only permitted to be installed in a voltage-free state.

1. Disconnect the power supply cable to the B&R industrial PC (disconnect the power cable).
2. Carry out electrostatic discharge on the housing or at the ground connection.
3. Loosen the Torx screws (T10) of the cover. Their number may vary depending on the system unit.

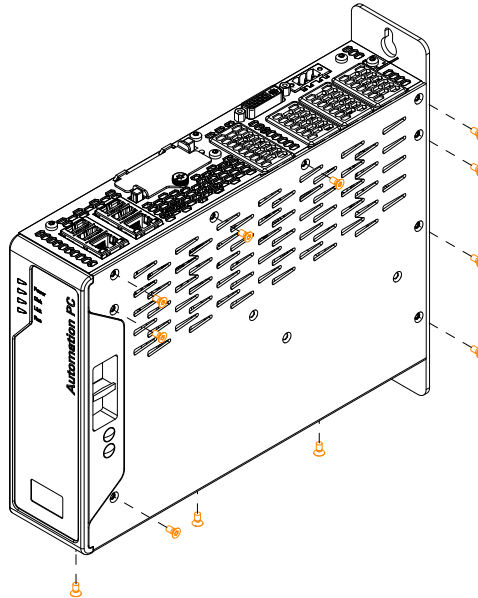

4. Remove the cover.

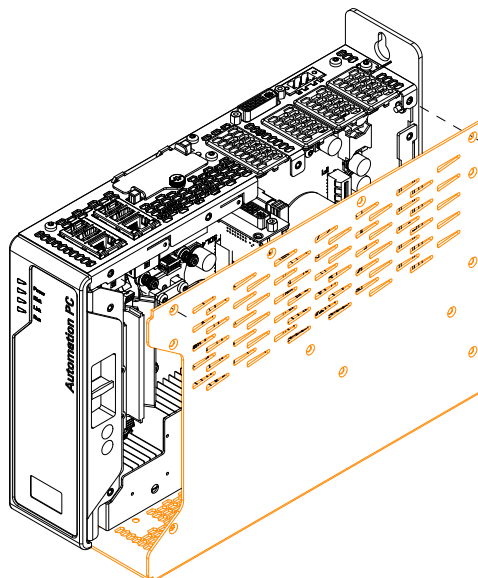

5. Pull the slot cover out of the housing (only when replacing IF options).

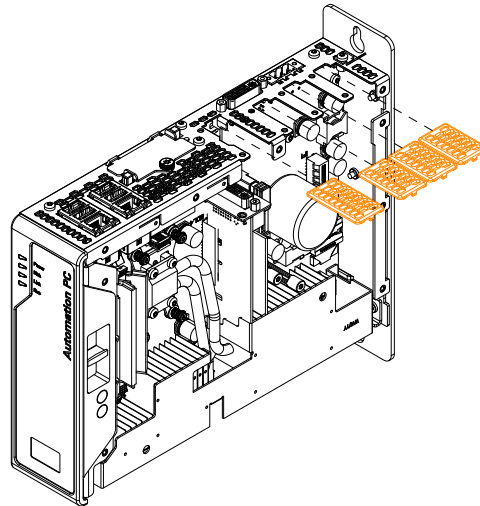

6.

- a) Insert the interface option into the appropriate slot (see section ["Device interfaces and slots"](#) on [page 39](#) for the respective IF option or the associated data sheet of the module starting on [page 64](#)). The interface option must be mounted inside the housing in order to be installed properly.

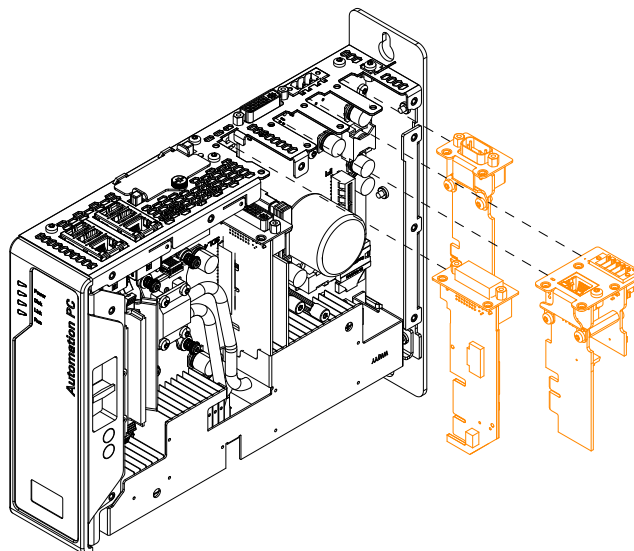

- b) When replacing the DDR4 SDRAM, the locking mechanism (marked in the figure) must first be released. The module can be inserted or replaced. The locking mechanism engages and locks the SDRAM module when properly mounted.

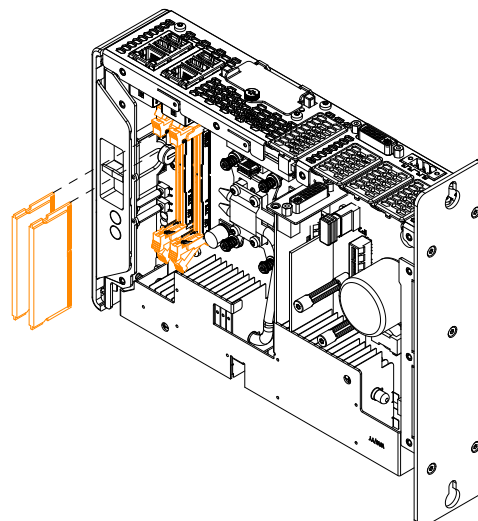

7. Fasten the interface option to the housing using the Torx screws (T10).

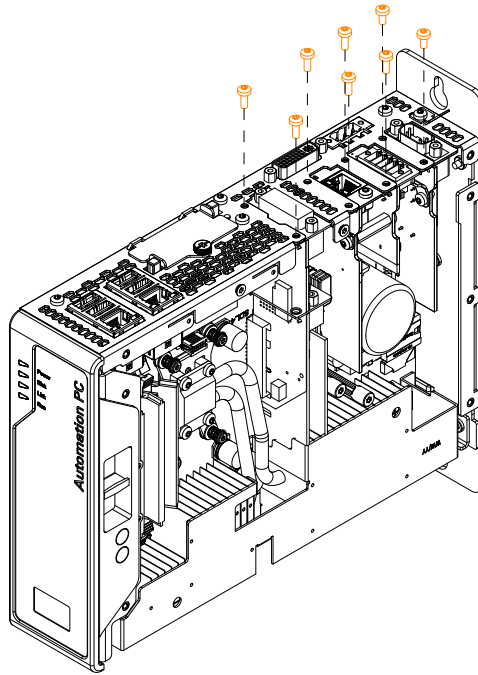

8. Install the cover.

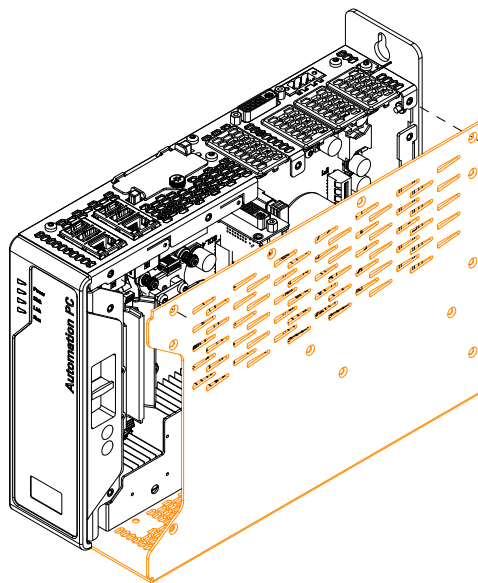

9. Install the cover on the housing using the Torx screws (T10).

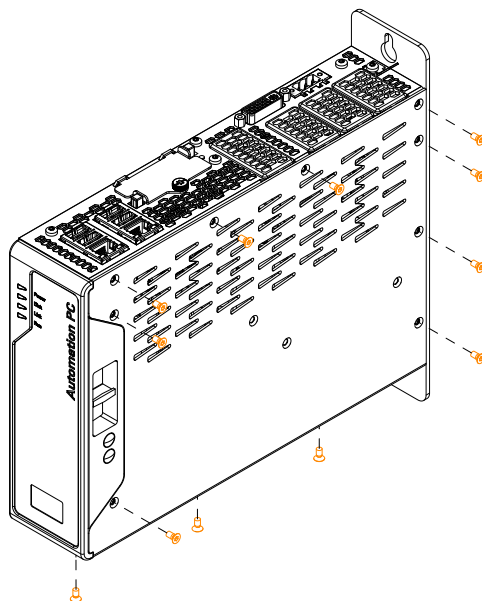

### 8.3.1 Installing M.2 mass storage devices

M.2 mass storage devices must be installed in adapter card 5ACCMS01.MDT2-000 as follows:

1. Insert the mass storage device into the connection strip block at angle  $\alpha$  of 5 to 20° (1) and then carefully press it into a horizontal position (2).

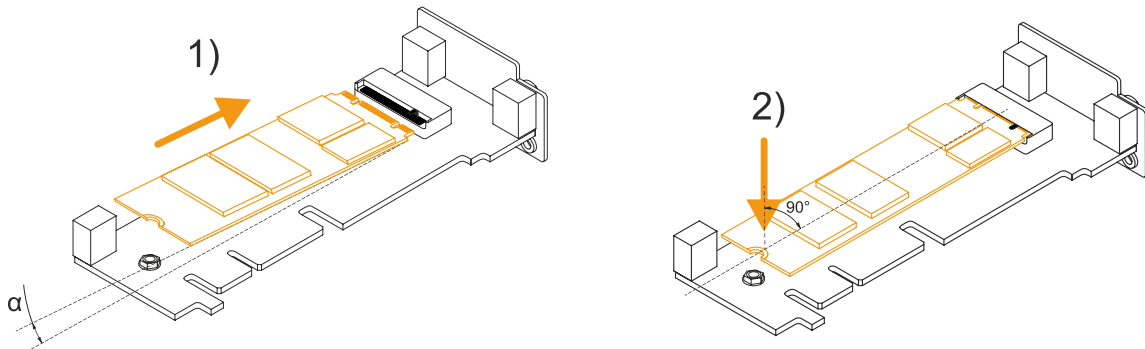

2. Secure the mass storage device with an M2.5 Torx screw size T8 (max. tightening torque 0.45 Nm). The force-fit nut is not permitted to be loosened and installed between the mass storage device and the screw!

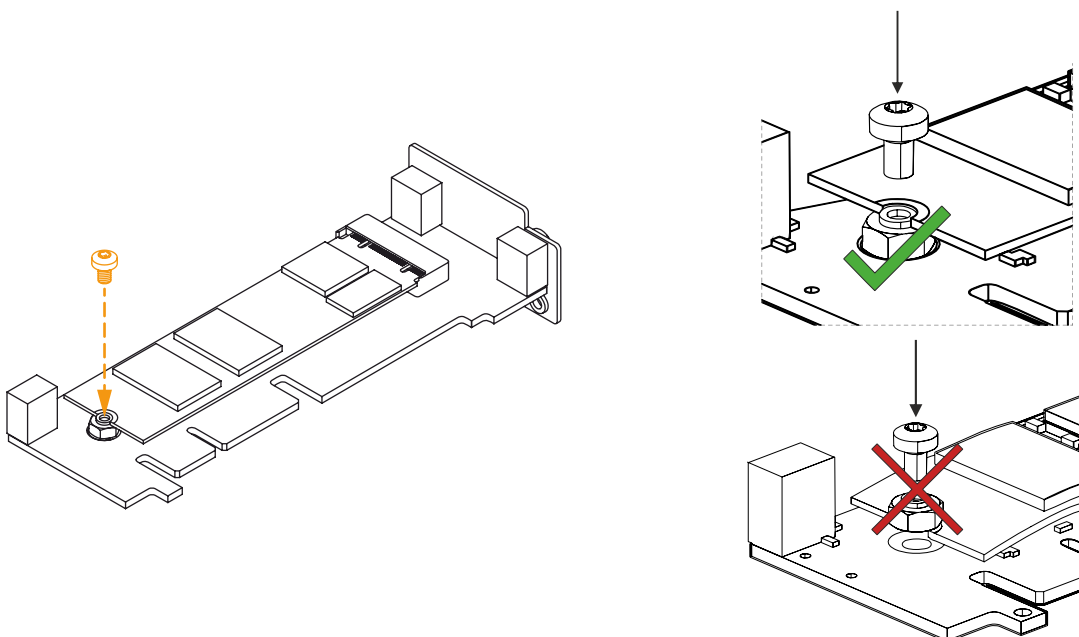

- ✓ The mass storage device is installed, and the adapter card can be installed in the PC.

Installation in an APC3100/PPC3100 must be carried out according to the description in section "[Installing the interface option and DDR4 SDRAM](#)" on page 220. Installation takes place in slot *IF option 3*.



## 8.4 Installing and connecting the UPS battery unit

### Information:

For information about installing the UPS IF option, see section "Installing the interface option and DDR4 SDRAM" on page 220.

### Warning!

Opening the UPS battery unit is not permitted!

1. Disconnect the power supply cable to the B&R industrial PC.
2. Install the battery unit. For the drilling template, see the technical data for the respective UPS battery unit. The spacing between the battery unit and B&R industrial PC must be selected so that they can be connected together with the UPS cable; note the cable length.  
4 M5 screws, 4 flat washers and 1 screw locking washer are needed for installation (min. tightening torque 1.3 Nm, screw-in depth per applicable DIN regulations and the application). These are not included in delivery.
3. Connect the UPS cable to the battery. To do so, connect the red and black wires to the power supply (**orange** screw clamp terminal). Connect the white and brown wires to the temperature sensor (**green** screw clamp terminal).

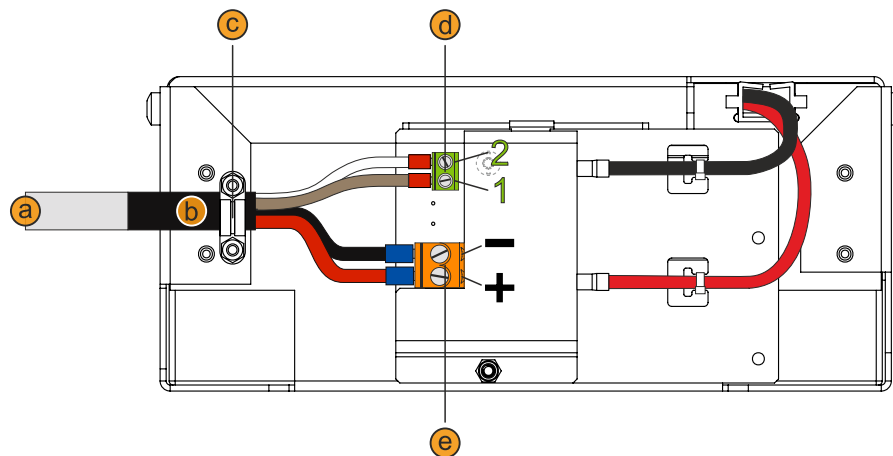

Legend			
a	UPS cable	b	Heat shrink tubing
c	Cable clamp	d	Temperature sensor connection
e	Battery unit connection		
Temperature sensor screw clamp terminal (green)			
1	Brown	2	White
Power supply screw clamp terminal (orange)			
+	Red	-	Black

4. Tighten the connected wires to the screw clamp terminals with a screwdriver (max. tightening torque 0.4 Nm).
5. Loosen both nuts (M3) on the cable clamp and feed the UPS cable through.
6. Fasten the UPS cable using the cable clamp. Alternately tighten the previously removed nuts onto the cable clamp (max. tightening torque 0.35 Nm).
7. Connect the 4-pin screw clamp terminal block to the UPS IF option and tighten the two screws with a screwdriver (max. tightening torque 0.4 Nm).

### 8.4.1 Permissible mounting orientations

The UPS battery unit is only permitted to be installed as illustrated below.

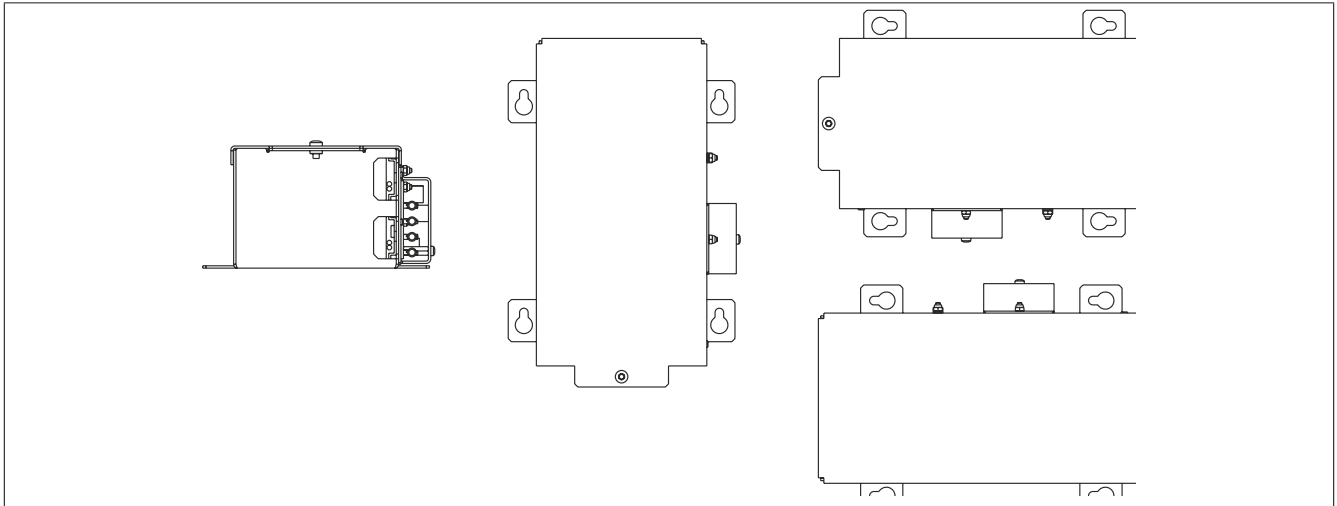

Figure 25: 5AC901.BUPS-0x - Mounting orientation

## 8.5 Repairs/Complaints and replacement parts

### **Danger!**

Unauthorized opening or repair of a device may result in personal injury and/or serious damage to property. Repairs are therefore only permitted to be carried out by authorized qualified personnel at the manufacturer's premises.

To process a repair/complaint, a repair order or complaint must be created via the B&R Material Return Portal on the B&R website ([www.br-automation.com](http://www.br-automation.com)).

## 9 Accessories

The following accessories have undergone functional testing by B&R in connection with the device used and can be operated with this device. Possible limitations regarding operation with individual components other than the complete system must be taken into account, however. All individual specifications of the components must be observed when operating the complete system.

All components listed in this manual have undergone intensive system and compatibility testing and been approved accordingly. B&R cannot assume any functional warranty for accessories that have not been approved.

### 9.1 General information

The following products can be used in the event of loss or for conversion or retrofitting.

#### 9.1.1 Order data

Material number	Description
5ACCRHMI.0000-000	HMI grounding clip
5ACCRHMI.0001-000	Retaining clips 16 mm - 14 pcs. with 16 mm setscrews - For AP1000 and AP9x3
5ACCRHMI.0002-000	Retaining clips 20 mm - 14 pcs. with 20 mm setscrews - For AP1000 and AP9x3
5ACCRHMI.0003-000	Retaining clips 25 mm - 12 pcs. with 25 mm setscrews - For AP1000 and AP9x3
5ACCRPC3.0006-000	APC/PPC3100 slot covers - 3x IF option - 1x graphics option
5ACCRPC3.0007-000	APC/PPC3100 CFast cover
5ACCRPC3.0012-000	APC/PPC3100 battery holder - 1x orange - 1x gray

### 9.2 Installation accessories

Suitable tool sets can be ordered to easily install B&R industrial PCs and converters.

- ESD-protected
- Screwdriver with quick-change chuck
- Consisting of:

#### 5ACCRHMI.0006-000

- 1x torque screwdriver: 0.3 to 1.2 Nm
- 1x bit set (5 pieces): Hex recess (2.5 mm, 3.0 mm, 5.0 mm), Torx (T10, T20)

#### 9.2.1 Order data

Order number	Short description	Figure
5ACCRHMI.0006-000	<p><b>Other</b></p> <p>HMI installation tool for control cabinet - 1x torque wrench ESD 0.3 - 1.2 Nm - 1x hex-head bit 2.5, length 89 mm - 1x hex-head bit 3.0, length 89 mm - 1x hex-head bit 5.0, length 89 mm - 1x Torx 10 bit, length 90 mm - 1x Torx 20 bit, length 89 mm</p>	

## 9.3 OTB103.9x

### 9.3.1 General information

1-row 3-pin terminal block OTB103 is used for the power supply.

### 9.3.2 Order data

Order number	Short description	Figure
OTB103.9	Connector 24 VDC - 3-pin, female - Screw clamp terminal block 3.31 mm <sup>2</sup>	
OTB103.91	Connector 24 VDC - 3-pin, female - Cage clamp terminal block 3.31 mm <sup>2</sup>	

### 9.3.3 Technical data

#### Information:

The following specified characteristic data, features and limit values are only valid for this accessory and may differ from those of the complete system. The data specified for the complete system applies to the complete system in which this accessory is installed, for example.

Order number	OTB103.9	OTB103.91
<b>General information</b>		
Certifications		
CE	Yes	
UL	cULus E115267 Industrial control equipment	
HazLoc	cULus HazLoc E180196 Industrial control equipment for hazardous locations Class I, Division 2, Groups ABCD, T4 <sup>1)</sup>	
DNV	Temperature: <b>B</b> (0 - 55°C) Humidity: <b>B</b> (up to 100%) Vibration: <b>A</b> (0.7 g) EMC: <b>B</b> (bridge and open deck) <sup>2)</sup>	
KR	Yes	
EAC	Yes	
<b>Terminal block</b>		
Note	Protected against vibration by the screw flange Nominal data per UL	
Number of pins	3 (female)	
Type of terminal block	Screw clamp terminal block variant	Cage clamp terminal block variant <sup>3)</sup>
Cable type	Only copper wires (no aluminum wires!)	
Pitch	5.08 mm	
Connection cross section		
AWG wire	26 to 14 AWG	26 to 12 AWG
Wire end sleeves with plastic covering	0.20 to 1.50 mm <sup>2</sup>	
Solid wires	0.20 to 2.50 mm <sup>2</sup>	
Fine-stranded wires	0.20 to 1.50 mm <sup>2</sup>	0.20 to 2.50 mm <sup>2</sup>
With wire end sleeves	0.20 to 1.50 mm <sup>2</sup>	
Tightening torque	0.4 Nm	-
<b>Electrical properties</b>		
Nominal voltage	300 V	
Nominal current <sup>4)</sup>	10 A / contact	
Contact resistance	≤5 mΩ	
<b>Operating conditions</b>		
Pollution degree per EN 61131-2	Pollution degree 2	

- 1) Yes, but applies only if all components installed in the complete system have this certification and the complete system bears the corresponding mark.
- 2) Yes, but applies only if all components installed in the complete system have this certification and are listed on the associated DNV certificate for the product family.
- 3) The cage clamp terminal block cannot be used side by side.
- 4) The respective limit data of the I/O modules must be taken into account!

## 9.4 Terminal block ready relay

### 9.4.1 0TB2104.8000

#### 9.4.1.1 General information

This 1-row, 4-pin TB2104 terminal block is used for ready relay 5AC901.IRDY-00.

#### 9.4.1.2 Order data

Order number	Short description	Figure
	<b>Terminal blocks</b>	
0TB2104.8000	Connector 24 VDC - 4-pin female - Screw clamp terminal block 2.5 mm <sup>2</sup>	

#### 9.4.1.3 Technical data

### Information:

The following specified characteristic data, features and limit values are only valid for this accessory and may differ from those of the complete system. The data specified for the complete system applies to the complete system in which this accessory is installed, for example.

Order number	0TB2104.8000
<b>General information</b>	
Certifications	
CE	Yes
UL	cULus E115267 Industrial control equipment
EAC	Yes
<b>Terminal block</b>	
Note	Nominal data per UL
Number of pins	4 (female)
Type of terminal block	Screw clamp terminal block variant
Cable type	Only copper wires (no aluminum wires!)
Pitch	5.08 mm
Connection cross section	
AWG wire	26 to 14 AWG
Wire end sleeves with plastic covering	0.2 to 1.5 mm <sup>2</sup>
Solid wires	0.2 to 2.5 mm <sup>2</sup>
Fine-stranded wires	0.2 to 1.5 mm <sup>2</sup>
With wire end sleeves	0.2 to 1.5 mm <sup>2</sup>
<b>Electrical properties</b>	
Nominal voltage	300 V
Nominal current <sup>1)</sup>	10 A
<b>Operating conditions</b>	
Pollution degree per EN 61131-2	Pollution degree 2

1) The respective limit data of the IF option must be taken into account!

## 9.5 Replacement CMOS batteries

### 9.5.1 0AC201.91 / 4A0006.00-000

#### 9.5.1.1 General information

The lithium battery is needed to retain BIOS CMOS data and to back up the real-time clock (RTC).

The battery is subject to wear and must be replaced if the battery capacity is insufficient (state "Bad").

#### 9.5.1.2 Order data

Order number	Short description	Figure
	<b>Batteries</b>	
0AC201.91	Lithium batteries 4 pcs., 3 V / 950 mAh button cell	
4A0006.00-000	Lithium battery, 3 V / 950 mAh, button cell	

#### 9.5.1.3 Technical data

### Warning!

The battery is only permitted to be replaced with a CR2477N battery. The use of any other battery may present a risk of fire or explosion.

The battery can explode if handled improperly. Do not recharge, disassemble or dispose of the battery in fire.

### Information:

The following specified characteristic data, features and limit values are only valid for this accessory and may differ from those of the complete system. The data specified for the complete system applies to the complete system in which this accessory is installed, for example.

Order number	0AC201.91	4A0006.00-000
<b>General information</b>		
Storage time	Max. 3 years at 30°C	
Certifications		
CE	Yes	
UL	cULus E115267 Industrial control equipment	
<b>Electrical properties</b>		
Capacity	950 mAh	
Self-discharge	<1% per year (at 23°C)	
Voltage range	3 V	
<b>Operating conditions</b>		
Pollution degree per EN 61131-2	Pollution degree 2	
<b>Ambient conditions</b>		
Temperature		
Storage	-20 to 60°C	
Relative humidity		
Operation	0 to 95%	
Storage	0 to 95%	
Transport	0 to 95%	

## 9.6 USB mass storage device

For additional information about compatible USB mass storage devices, see the B&R website ([USB mass storage devices](#)).

## 9.7 Cables

For additional information about compatible cables, see the B&R website ([HMI cable manual](#)).



# 10 International and national certifications

---

## 10.1 Directives and declarations

### 10.1.1 CE marking



All directives applicable to the respective product and their harmonized EN standards are met.

### 10.1.2 EMC Directive

The products meet the requirements of EU directive "Electromagnetic compatibility 2014/30/EU" and are designed for industrial applications:

EN 61131-2:2007	Programmable controllers - Part 2: Equipment requirements and tests
EN 61000-6-2:2005	Electromagnetic compatibility (EMC) - Part 6-2: Generic standards - Immunity for industrial environments
EN 61000-6-4:2007	Electromagnetic compatibility (EMC) - Part 6-4: Generic standards - Emission standard for industrial environments

#### **Information:**

The declarations of conformity are available on the B&R website under [Declarations of conformity](#).

## 10.2 Certifications

### Danger!

**A complete system can only receive certification if all individual components installed and connected in it have the corresponding certifications. If an individual component is used that does not have the corresponding certification, the complete system will also not be certified.**

B&R products and services comply with applicable standards. These are international standards from organizations such as ISO, IEC and CENELEC, as well as national standards from organizations such as UL, CSA, FCC, VDE, ÖVE, etc. We pay special attention to the reliability of our products in the industrial sector.

### Information:

**The certifications valid for the respective product are available on the website and in the user's manual under the technical data in section "Certifications" or in the associated certificates.**

#### 10.2.1 UL certification



Ind. Cont. Eq.  
E115267

Products with this mark are tested by Underwriters Laboratories and listed as "industrial control equipment". The mark is valid for the USA and Canada and facilitates the certification of your machines and systems in this economic area.

Underwriters Laboratories (UL) per standards UL 61010-1 and UL 61010-2-201 Canadian (CSA) standard per C22.2 No. 61010-1-12 and CSA C22.2 No. 61010-2-201:14

The UL certificates are available on the B&R website under [Downloads - Certificates - UL](#).

When using industrial control equipment per UL 61010-1 / UL 61010-2-201, make sure that the device is classified as "open type". The prerequisite for certification or operation per UL 61010-1 / UL 61010-2-201 is therefore the installation of the device in an appropriate protective housing.

#### 10.2.2 EAC



Products with this mark are tested by an accredited test laboratory and permitted to be imported into the Eurasian Customs Union (based on EU conformity).

#### 10.2.3 KC



Products with this mark are tested by an accredited test laboratory and permitted to be introduced into the Korean market (based on EU conformity).

#### 10.2.4 RCM



Products with this mark are tested by an accredited test laboratory and certified by the ACMA. The mark is valid for Australia/Oceania and facilitates the certification of your machines and systems in this economic area (based on EU conformity).

### 10.2.5 DNV certification



Products with this certification are certified by the classification society DNV and suitable for the maritime sector. DNV certificates (type approvals) are generally accepted by other classification societies during ship acceptance procedures.

DNV per standard DNVGL-CG-0339 from December 2019  
 IACS E10 Rev. 7  
 EN 60945 section 1c

These products are suitable for the following DNV ambient conditions (DNV classes):

Temperature	B
Moisture	B
Vibration	A
EMV	B
Housing	For onboard installation, the regulations for compliance with the required degree of protection must be observed.

Products used on a ship's bridge must be dimmable using software in accordance with the regulations and guidelines from the respective classification society.

DNV certificates with specifications for permissible ambient conditions, as well as a list of revisions from which DNV type approval applies to individual devices, are available on the B&R website ([www.br-automation.com](http://www.br-automation.com)) ([Maritime certificates](#)).

## 10.2.6 UL Haz. Loc. certification



Products with this mark are tested by Underwriters Laboratories and listed as "industrial control equipment for use in hazardous locations". The mark is valid for the USA and Canada and facilitates the certification of your machines and systems in this economic area.

Underwriters Laboratories (UL) per standard ANSI/ISA 12.12.01  
Canadian (CSA) standard per C22.2 no. 213-16

Ind. Cont. Eq.  
for Haz. Locs.  
Cl. I, Div. 2,  
Groups ABCD  
E180196 (T4)

The UL HazLoc certificates are available on the B&R website under [Downloads - Certificates - HazLoc](#).

### 10.2.6.1 General safety guidelines

APC3100 systems that are certified for use in potentially explosive atmospheres and bear the mark above are suitable for use in Class 1, Division 2, Groups A, B, C and D or in nonexplosive atmospheres and correspond to the following standards: UL Std. 61010-1, 3rd Edition, ANSI/ISA 12.12.01:2015, CSA Std. C22.2 No. 61010-1-12, 3rd Edition, CSA Std. C22.2 No. 213-16.

### 10.2.6.2 Assembly and installation

Explosion-protected devices must be used as intended and are only permitted to be operated by qualified and instructed specialists in accordance with these installation instructions and the additional information in the user's manual. Any other operation endangers the safety and function of the devices and connected systems. The operator is responsible for compliance with applicable safety and accident prevention regulations and standards.

Devices must be installed in a suitable protective housing that can only be opened using a tool. In order to ensure sufficient air circulation, the specified clearances must be observed. Use only in environments with pollution degree 2. The maximum ambient temperature differs depending on the individual components used.

Max. ambient temperatures deviating from the specifications in chapter "[Maximum ambient temperature for worst-case operation](#)" on page 30 must be observed for the following products for UL HazLoc-compliant operation. If additional derating is required due to other factors (e.g. the individual components used), the calculation must be based on the values specified below.

Order number	Max. ambient temperature UL HazLoc
5APC3100.KBU0-000	50°C
5APC3100.KBU1-000	50°C

Before any installation or use of a device in potentially explosive atmospheres, the certification mark on the device must be checked. Additional equipment must be suitable for the place of use. Final assembly must be approved by the responsible local authorities. Wiring must be carried out in accordance with national regulations and the requirements of the authorities.

Devices must be disconnected from the power supply until installation work has been completed. The tightening torque for power supply terminals is 0.5 Nm. Cables must be suitable for a surface temperature of 75°C. APC3100 systems are only permitted to be operated with 24 VDC.

Unshielded/Ungrounded cables are never permitted to be used in potentially explosive atmospheres. Devices must be securely connected to equipotential bonding. Power supply, communication and accessory cables must be secured to the device or control cabinet. Power supply, communication and accessory cables are not permitted to exert excessive strain on connections. Possible vibrations in the environment must be taken into account.

### 10.2.6.3 Operation

To switch APC3100 systems on/off in a potentially explosive atmosphere, either a switch must be located outside the potentially explosive atmosphere or a switch certified for use in potentially explosive atmospheres must be used.

## Danger!

**Explosion hazard: Accessories are not permitted to be connected or disconnected when the power is switched on unless the area is considered nonhazardous and is free of ignitable concentrations!**

**Explosion hazard: Replacing components may impair eligibility for Class I, Division 2!**

**Danger !**

**Risque d'explosion – Ne pas connecter ou déconnecter un quelconque équipement lorsque le circuit est sous tension, à moins que la zone soit connue comme étant sans risque et sans concentrations inflammables!**

**Risque d'explosion – Le remplacement de composants peut compromettre l'aptitude au respect de la Classe I, Division 2!**

With the exception of USB dongle 0TG1000.01 or in accordance with the requirements listed in "[USB connection with the Automation PC 3100](#)" and "[USB connection with optional DisplayPort graphics option](#)", USB interfaces are not certified for operation in potentially explosive areas and are only permitted to be used for service purposes.

**10.2.6.4 Servicing, disturbances and disassembly**

Devices must be taken out of operation and protected against accidental startup. The actual disconnection of the power supply must be checked with a suitable voltmeter.

Before removing or installing accessories, components or cables, the power supply to APC3100 systems and power supply unit must be interrupted. Defective devices are only permitted to be replaced by trained personnel. Before switching on or connecting to the power supply, all covers or components of the system must be reinstalled and secured.

**Danger!**

**Failure to follow this instruction can result in death, serious bodily injury or damage to property!**

**Danger !**

**Le non-respect de ces instructions peut entraîner des blessures graves ou mortelles!**

## 10.2.6.5 USB connection with the Automation PC 3100

### 10.2.6.5.1 Introduction

The information below describes the use of USB peripheral devices on USB interfaces 1, 2, 3 and 4 of the B&R Automation PC 3100 in hazardous locations Class I, Division 2, Groups A, B, C and D.

## Danger!

### EXPLOSION HAZARD

- Before installation or use in potentially explosive atmospheres, the explosion protection class of the device must be checked according to ANSI/ISA 12.12.01 and CSA C22.2 N°213.
- To switch on/off B&R devices that are installed in potentially explosive atmospheres, at least one of the following measures must be taken:
  - The switch is positioned outside the potentially explosive atmosphere.
  - A switch certified according to the hazardous location class and division for "tube use" is used.
- As long as the electrical circuit is activated, cables or lines are not permitted to be connected or disconnected unless the area is knowingly free of flammable concentrations of vapors, gases and other flammable or combustible materials. This applies to all connections and circuits. This includes power, ground and network connections as well as series and parallel connections.
- Unshielded/Ungrounded cables are never permitted to be used in potentially explosive atmospheres.
- Only configurations with nonincendive USB devices are permitted to be used.
- The doors and openings of housings must always remain closed. This prevents the accumulation of foreign bodies within the workstation.

Failure to follow this instruction can result in death, serious bodily injury or damage to property!

### 10.2.6.5.2 Description

Nonincendive devices (keyboards, mouse) are certified for use on the rear USB interfaces of the B&R Automation PC 3100 (connected device) and are permitted to be connected and disconnected during operation. In addition to the nonincendive property, devices that can be connected to the 4 USB interfaces must meet the following criteria.

The figure shows a sketch of the wiring of the USB cable:

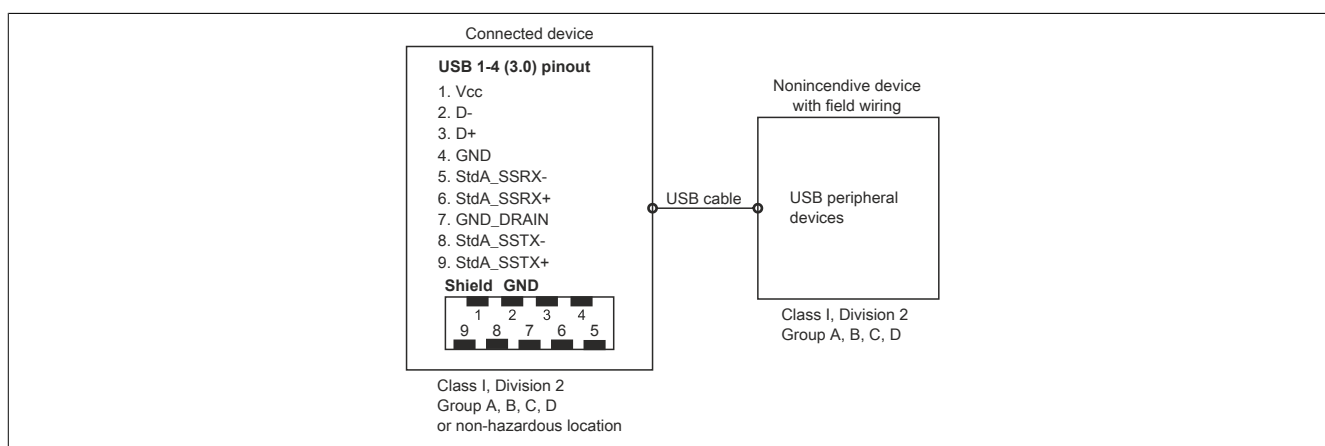

The following tables indicate the nonincendive electrical circuit parameters:

USB1, USB2, USB3 and USB4 interfaces (USB 3.0):	
Open-circuit voltage [ $V_{oc}$ ]	5.0 V
Short-circuit current [ $I_{sc}$ ]	8.06 A
Connected capacity [ $C_a$ ]	20 $\mu$ F
Connected inductance [ $L_a$ ]	4.8 $\mu$ H

Table 154: Nonincendive electrical circuit parameters for the USB1, USB2, USB3 and USB4 interfaces

The unit concept allows the interconnection of nonincendive devices with connected devices with non-specifically tested combinations as a system. For this purpose, the permissible values of  $V_{oc}$  (or  $U_o$ ) and  $I_{sc}$  (or  $I_o$ ) for the connected device must be less than or equal to  $V_{max}$  ( $U_i$ ) and  $I_{max}$  ( $I_i$ ) for the nonincendive device, the permissible values of  $C_a$  ( $C_o$ ) and  $L_a$  ( $L_o$ ) for the connected device must be greater than or equal to  $C_i + C_{Cable}$  and  $L_i + L_{Cable}$  for the nonincendive device with field wiring.

The nonincendive device with field wiring must meet the following criteria:

B&R device (connected device)	-	Connected, nonincendive device with field wiring (mouse, keyboard)
$V_{oc}$	$\leq$	$V_{max}$
$I_{sc}$	$\leq$	$I_{max}$
$C_a$	$\geq$	$C_i + C_{Cable}$
$L_a$	$\geq$	$L_i + L_{Cable}$

Table 155: Connected, nonincendive device with field wiring

If the electrical parameters of the cable are unknown, the following values can be used:

Where  $C_{Cable} = 196.85 \text{ pF/m}$  (60 pF/ft) if unknown

Where  $L_{Cable} = 0.656 \text{ }\mu\text{H/m}$  (0.20  $\mu\text{H/ft}$ ) if unknown

Wiring must be carried out in accordance with national regulations and the requirements of the authorities.

The B&R device must be installed in a suitable protective housing. For installations in Class I, Division 2 hazardous locations, the housing must be capable of withstanding one or more Division 2 wiring methods.

## Warning!

- Replacing components may impair the suitability of the Division 2 hazardous location (classified) under certain circumstances.
- As long as the area is knowingly at risk of explosion, the device is not permitted to be switched on or off.
- The nonincendive device with field wiring is not permitted to be connected via a parallel connection. This is valid unless the device has received express permission for this.

The B&R device is suitable for use in Class I, Division 2, Groups A, B, C and D areas. It also provides nonincendive field wiring for devices in Class I, Division 2, Groups A, B, C and D.

### 10.2.6.6 USB connection with optional DisplayPort graphics option

#### 10.2.6.6.1 Introduction

The information below describes the use of USB peripheral devices on the USB interface of the DisplayPort graphics option in the B&R Automation PC 3100 in hazardous locations Class I, Division 2, Groups A, B, C and D.

## Danger!

### EXPLOSION HAZARD

- Before installation or use in potentially explosive atmospheres, the explosion protection class of the device must be checked according to ANSI/ISA 12.12.01 and CSA C22.2 N°213.
- To switch on/off B&R devices that are installed in potentially explosive atmospheres, at least one of the following measures must be taken:
  - The switch is positioned outside the potentially explosive atmosphere.
  - A switch certified according to the hazardous location class and division for "tube use" is used.
- As long as the electrical circuit is activated, cables or lines are not permitted to be connected or disconnected unless the area is knowingly free of flammable concentrations of vapors, gases and other flammable or combustible materials. This applies to all connections and circuits. This includes power, ground and network connections as well as series and parallel connections.
- Unshielded/Ungrounded cables are never permitted to be used in potentially explosive atmospheres.
- Only configurations with nonincendive USB devices are permitted to be used.
- The doors and openings of housings must always remain closed. This prevents the accumulation of foreign bodies within the workstation.

Failure to follow this instruction can result in death, serious bodily injury or damage to property!

#### 10.2.6.6.2 Description

Nonincendive devices (keyboards, mouse) are certified for use on the USB interface of the DisplayPort graphics option in the B&R Automation PC 3100 (connected device) and are permitted to be connected and disconnected during operation. In addition to the nonincendive property, devices that can be connected to the USB1 interface must meet the following criteria.

The figure shows a sketch of the wiring of the USB cable:

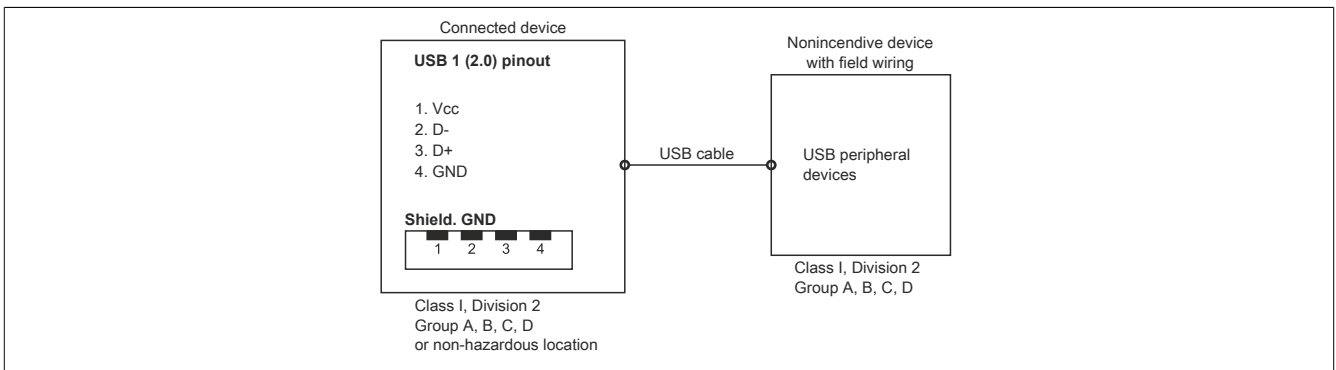

The following tables indicate the nonincendive electrical circuit parameters:

USB1 interface (USB 2.0):	
Open-circuit voltage [ $V_{oc}$ ]	5.0 V
Short-circuit current [ $I_{sc}$ ]	8.16 A
Connected capacity [ $C_a$ ]	20 $\mu$ F
Connected inductance [ $L_a$ ]	4.8 $\mu$ H

Table 156: Nonincendive circuit parameters for the USB1 interface

The unit concept allows the interconnection of nonincendive devices with connected devices with non-specifically tested combinations as a system. For this purpose, the permissible values of  $V_{oc}$  (or  $U_o$ ) and  $I_{sc}$  (or  $I_o$ ) for the connected device must be less than or equal to  $V_{max}$  ( $U_i$ ) and  $I_{max}$  ( $I_i$ ) for the nonincendive device, the permissible values of  $C_a$  ( $C_o$ ) and  $L_a$  ( $L_o$ ) for the connected device must be greater than or equal to  $C_i + C_{Cable}$  and  $L_i + L_{Cable}$  for the nonincendive device with field wiring.



The nonincendive device with field wiring must meet the following criteria:

B&R device (connected device)	-	Connected, nonincendive device with field wiring (mouse, keyboard)
$V_{oc}$	$\leq$	$V_{max}$
$I_{sc}$	$\leq$	$I_{max}$
$C_a$	$\geq$	$C_i + C_{cable}$
$L_a$	$\geq$	$L_i + L_{cable}$

Table 157: Connected, nonincendive device with field wiring

If the electrical parameters of the cable are unknown, the following values can be used:

Where  $C_{Cable} = 196.85 \text{ pF/m}$  (60 pF/ft) if unknown

Where  $L_{Cable} = 0.656 \text{ }\mu\text{H/m}$  (0.20  $\mu\text{H/ft}$ ) if unknown

Wiring must be carried out in accordance with national regulations and the requirements of the authorities.

The B&R device must be installed in a suitable protective housing. For installations in Class I, Division 2 hazardous locations, the housing must be capable of withstanding one or more Division 2 wiring methods.

## Warning!

- Replacing components may impair the suitability of the Division 2 hazardous location (classified) under certain circumstances.
- As long as the area is knowingly at risk of explosion, the device is not permitted to be switched on or off.
- The nonincendive device with field wiring is not permitted to be connected via a parallel connection. This is valid unless the device has received express permission for this.

The B&R device is suitable for use in Class I, Division 2, Groups A, B, C and D areas. It also provides nonincendive field wiring for devices in Class I, Division 2, Groups A, B, C and D.

# 11 Environmentally friendly disposal

---

All programmable logic controllers, operating and monitoring devices and uninterruptible power supplies from B&R are designed to have as little impact on the environment as possible.

## 11.1 Separation of materials

To ensure that devices can be recycled in an environmentally friendly manner, it is necessary to separate out the different materials.

Component	Disposal
Programmable logic controllers Operating and monitoring devices Uninterruptible power supplies Batteries and rechargeable batteries Cables	Electronics recycling
Paper/Cardboard packaging	Paper/Cardboard recycling
Plastic packaging material	Plastic recycling

Disposal must be carried out in accordance with applicable legal regulations.

## Appendix A Maintenance Controller Extended (MTCX)

The MTCX controller (FPGA processor) is located on the mainboard (component of every system unit) of the APC3100 and PPC3100 device.



The MTCX is responsible for the following monitoring and control functions:

- Power failure logic and power on logic (power OK sequencing)
- Watchdog handling (NMI/reset handling)
- Temperature monitoring and fan control
- Key and LED handling/coordination (matrix keyboard of B&R panels)
- Advanced desktop operation (buttons, USB forwarding)
- Daisy chain display operation (touch screen, USB redirection)
- Panel locking mechanism (configurable via the ADI Control Center)
- Backlight control of a connected B&R display
- Calculating statistical data: Power-on cycles, power-on hours and fan hours (resolution: 15 min)
- SDL data transfer (display, matrix keyboard, touch screen, service data, USB)
- LED status indicators (Power, Disk, Link, Run)
- Optimal (default) BIOS settings are reported to BIOS by the MTCX depending on the existing hardware.

The functions of the MTCX can be extended by upgrading its firmware<sup>3)</sup>. The version can be read in BIOS or in approved Microsoft Windows operating systems using the ADI Control Center.

<sup>3)</sup> Can be downloaded from the Downloads section of the B&R website ([www.br-automation.com](http://www.br-automation.com)).

## Appendix B Reading LED status indicators

### Danger!

The device is not permitted to be opened and covers are not permitted to be removed during operation.

Before opening/removing covers, the device must be disconnected from the power supply.

The LED status indicators of installed IF options on xPC3100 devices are visible during operation through ventilation slots in the following area.

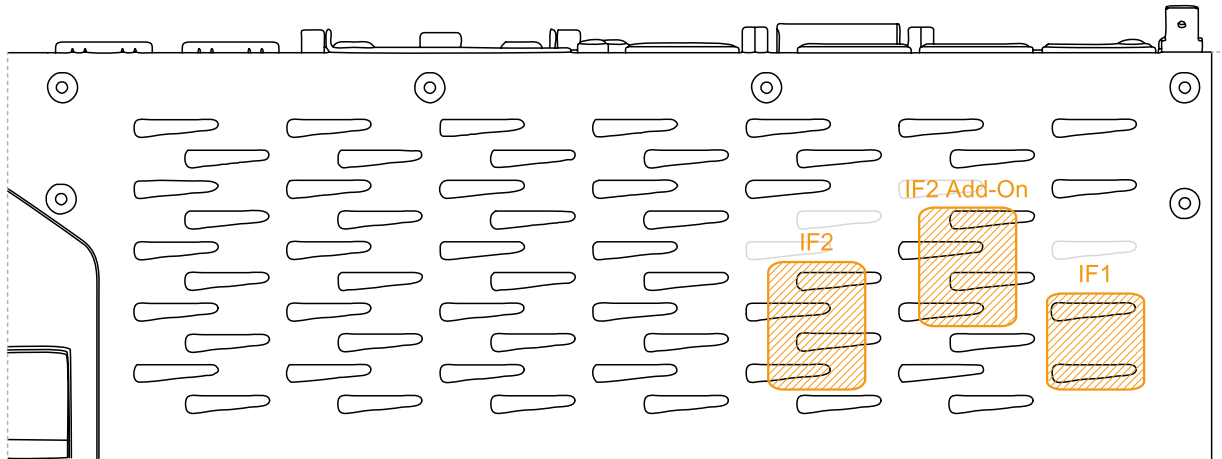

## Appendix C Cable data

Signal		Signal	
RS232	"RS232 - Bus length and cable type" on page 245	RS422	"RS422 - Bus length and cable type" on page 245
RS485	"RS485 - Bus length and cable type" on page 246	CAN	"CAN - Bus length and cable type" on page 246

### C.1 RS232 - Bus length and cable type

The maximum transfer rate of 115 kbit/s depends on the cable length and type of cable used.

Bus length	Transfer rate
≤15 m	Typ. 64 kbit/s
≤10 m	Typ. 115 kbit/s
≤5 m	Typ. 115 kbit/s

Preferably, the cable material used should have the following properties or deviate only slightly from them in order to achieve an optimal transfer rate.

RS232 cables		Property
<b>Signal line</b>		
	Cable cross section	4x 0.16 mm <sup>2</sup> (26 AWG), tinned copper stranded wire
	Wire insulation	PE
	Conductor resistance	≤82 Ω/km
	Stranding	Wires stranded in pairs
	Shield	Pair shielding with aluminum foil
<b>GND</b>		
	Cable cross section	1x 0.34 mm <sup>2</sup> (22AWG/19), tinned copper stranded wire
	Wire insulation	PE
	Conductor resistance	≤59 Ω/km
<b>Outer jacket</b>		
	Material	PUR compound
	Properties	Halogen-free
	Cable shield	Tinned copper wire

### C.2 RS422 - Bus length and cable type

The RTS line must be switched on to activate the transmitter.

The maximum transfer rate of 115 kbit/s depends on the cable length and type of cable used.

Bus length	Transfer rate
1200 m	Typ. 115 kbit/s

Preferably, the cable material used should have the following properties or deviate only slightly from them in order to achieve an optimal transfer rate.

RS422 cables		Property
<b>Signal line</b>		
	Cable cross section	4x 0.25 mm <sup>2</sup> (24AWG/19), tinned copper stranded wire
	Wire insulation	PE
	Conductor resistance	≤82 Ω/km
	Stranding	Wires stranded in pairs
	Shield	Pair shielding with aluminum foil
<b>GND</b>		
	Cable cross section	1x 0.34 mm <sup>2</sup> (22AWG/19), tinned copper stranded wire
	Wire insulation	PE
	Conductor resistance	≤59 Ω/km
<b>Outer jacket</b>		
	Material	PUR compound
	Properties	Halogen-free
	Cable shield	Tinned copper wire

### C.3 RS485 - Bus length and cable type

The maximum transfer rate of 115 kbit/s depends on the cable length and type of cable used.

Bus length	Transfer rate
1200 m	Typ. 115 kbit/s

Preferably, the cable material used should have the following properties or deviate only slightly from them in order to achieve an optimal transfer rate.

RS485 cables		Property
<b>Signal line</b>		
	Cable cross section	4x 0.25 mm <sup>2</sup> (24AWG/19), tinned copper stranded wire
	Wire insulation	PE
	Conductor resistance	≤82 Ω/km
	Stranding	Wires stranded in pairs
	Shield	Pair shielding with aluminum foil
<b>GND</b>		
	Cable cross section	1x 0.34 mm <sup>2</sup> (22AWG/19), tinned copper stranded wire
	Wire insulation	PE
	Conductor resistance	≤59 Ω/km
<b>Outer jacket</b>		
	Material	PUR compound
	Properties	Halogen-free
	Cable shield	Tinned copper wire

### C.4 CAN - Bus length and cable type

The type of cable to be used depends largely on the required bus length and number of nodes. The bus length is determined by the transfer rate. Per CiA (CAN in Automation), the maximum bus length is 1000 meters.

The following bus lengths are permitted at a maximum permissible oscillator tolerance of 0.121%:

Bus length <sup>1)</sup>	Transfer rate
≤1000 m	Typ. 50 kbit/s
≤200 m	Typ. 250 kbit/s
≤100 m	Typ. 500 kbit/s
≤20 m	Typ. 1 Mbit/s

1) The specified cable length is only valid with the values specified in "CAN driver settings". Cable lengths otherwise depend on the values in the bit timing register, cable quality and number of nodes.

Preferably, the cable material used should have the following properties or deviate only slightly from them in order to achieve an optimal transfer rate.

CAN cable		Property
<b>Signal line</b>		
	Cable cross section	2x 0.25 mm <sup>2</sup> (24AWG/19), tinned copper stranded wire
	Wire insulation	PE
	Conductor resistance	≤82 Ω/km
	Stranding	Wires stranded in pairs
	Shield	Pair shielding with aluminum foil
<b>GND</b>		
	Cable cross section	1x 0.34 mm <sup>2</sup> (22AWG/19), tinned copper stranded wire
	Wire insulation	PE
	Conductor resistance	≤59 Ω/km
<b>Outer jacket</b>		
	Material	PUR compound
	Properties	Halogen-free
	Cable shield	Tinned copper wire

# Appendix D POWERLINK

## D.1 LED "S/E" (status/error LED)

This LED is a green/red dual LED and indicates the state of the POWERLINK interface. The LED states have a different meaning depending on the operating mode of the POWERLINK interface.

### D.1.1 Ethernet mode

In this mode, the interface is operated as an Ethernet interface.

LED "S/E"		Description
Green	Red	
On	Off	The interface is operated as an Ethernet interface.

Table: LED "S/E": Interface in Ethernet mode

### D.1.2 POWERLINK V2 mode

#### Error message

LED "S/E"		Description
Green	Red	
Off	On	The interface is in error mode (failed Ethernet frames, increased number of collisions on the network, etc.). Note: Several red blinking signals are displayed immediately after the device is switched on. These are not errors, however.
Blinking	On	If an error occurs in the following modes, then the green LED blinks over the red LED: <ul style="list-style-type: none"> <li>• PRE_OPERATIONAL_1</li> <li>• PRE_OPERATIONAL_2</li> <li>• READY_TO_OPERATE</li> </ul>

Table: LED "S/E" - Error message (interface in POWERLINK mode)

#### Interface status

LED "S/E"		Description
Green	Red	
Off	Off	<p><b>Mode: NOT_ACTIVE</b> The interface is either in mode NOT_ACTIVE or one of the following modes or errors is present:</p> <ul style="list-style-type: none"> <li>• The device is switched off.</li> <li>• The device is in the startup phase.</li> <li>• The interface or device is not configured correctly in Automation Studio.</li> <li>• The interface or device is defective.</li> </ul> <p><b>Managing node (MN)</b> The network is monitored for POWERLINK frames. If a frame is not received within the configured time window (timeout), the interface immediately enters mode PRE_OPERATIONAL_1. If POWERLINK communication is detected before the time has elapsed, however, the MN is not started.</p> <p><b>Controlled node (CN)</b> The network is monitored for POWERLINK frames. If a frame is not received within the configured time window (timeout), the interface immediately enters mode BASIC_ETHERNET. If POWERLINK communication is detected before this time expires, however, the interface immediately enters mode PRE_OPERATIONAL_1.</p>

Table: LED "S/E" - Interface state (interface in POWERLINK mode)

LED "S/E"		Description
Green	Red	
Flickering (approx. 10 Hz)	Off	<p><b>Mode:</b> BASIC_ETHERNET The interface is in mode BASIC_ETHERNET. The interface is operated in Ethernet mode.</p> <p><b>Managing node (MN)</b> This mode can only be exited by resetting the controller.</p> <p><b>Controlled node (CN)</b> If POWERLINK communication is detected during this mode, the interface enters mode PRE_OPERATIONAL_1.</p>
	On	<p><b>Controlled node (CN)</b> If the red LED lights up in this mode, this means that the MN has failed.</p>
Single flash (approx. 1 Hz)	Off	<p><b>Mode:</b> PRE_OPERATIONAL_1 The interface is in mode PRE_OPERATIONAL_1.</p> <p><b>Managing node (MN)</b> The MN is in "reduced cycle" mode. The CNs are configured in this mode. Cyclic communication is not yet taking place.</p> <p><b>Controlled node (CN)</b> The CN can be configured by the MN in this mode. The CN waits until it receives an SoC frame and then switches to mode PRE_OPERATIONAL_2.</p>
	On	<p><b>Controlled node (CN)</b> If the red LED lights up in this mode, this means that the MN has failed.</p>
Double flash (approx. 1 Hz)	Off	<p><b>Mode:</b> PRE_OPERATIONAL_2 The interface is in mode PRE_OPERATIONAL_2.</p> <p><b>Managing node (MN)</b> The MN starts cyclic communication (cyclic input data is not yet evaluated). The CNs are configured in this mode.</p> <p><b>Controlled node (CN)</b> The CN can be configured by the MN in this mode. A command then switches the mode to READY_TO_OPERATE.</p>
	On	<p><b>Controlled node (CN)</b> If the red LED lights up in this mode, this means that the MN has failed.</p>
Triple flash (approx. 1 Hz)	Off	<p><b>Mode:</b> READY_TO_OPERATE The interface is in mode READY_TO_OPERATE.</p> <p><b>Managing node (MN)</b> Cyclic and asynchronous communication. Received PDO data is ignored.</p> <p><b>Controlled node (CN)</b> The configuration of the CN is completed. Normal cyclic and asynchronous communication. The transmitted PDO data corresponds to the PDO mapping. However, cyclic data is not yet evaluated.</p>
	On	<p><b>Controlled node (CN)</b> If the red LED lights up in this mode, this means that the MN has failed.</p>
On	Off	<p><b>Mode:</b> OPERATIONAL The interface is in mode OPERATIONAL. PDO mapping is active and cyclic data is evaluated.</p>
Blinking (approx. 2.5 Hz)	Off	<p><b>Mode:</b> STOPPED The interface is in mode STOPPED.</p> <p><b>Managing node (MN)</b> This mode does not occur for the MN.</p> <p><b>Controlled node (CN)</b> Output data is not being output, and no input data is being provided. This mode can only be reached and exited by a corresponding command from the MN.</p>

Table: LED "S/E" - Interface state (interface in POWERLINK mode)

**Blink times**

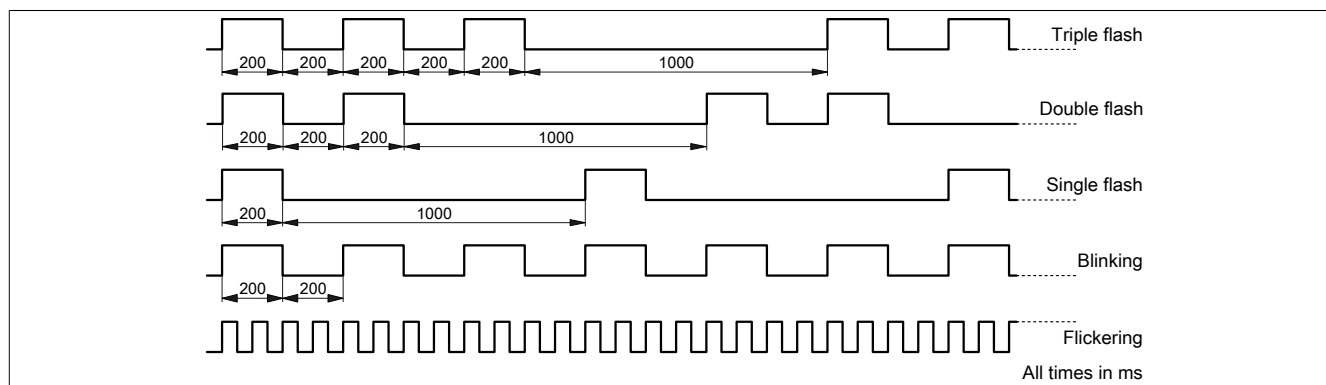



### D.1.3 System stop error codes

A system stop error can occur due to incorrect configuration or defective hardware.

The error code is indicated by LED "S/E" blinking red. The blinking signal of the error code consists of 4 switch-on phases with short (150 ms) or long (600 ms) duration. The error code is repeated every 2 seconds.

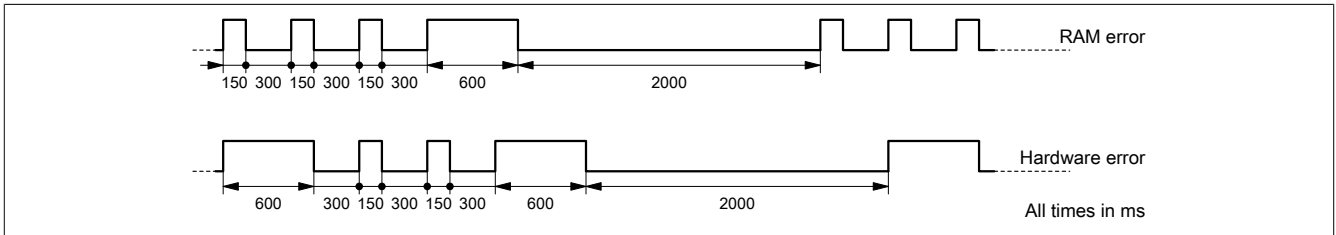

Error	Error description
RAM error	The device is defective and must be replaced.
Hardware error	The device or a system component is defective and must be replaced.

### D.1.4 POWERLINK V2

By default, the POWERLINK interface is operated as a managing node (MN). In the managing node, the node number is set to a fixed value of 240.

If the POWERLINK node is operated as a controlled node (CN), a node number from 1 to 239 can be set in the POWERLINK configuration in Automation Studio.

## Appendix E Abbreviations

---

Abbreviations used in the document are explained here.

Abbreviation	Stands for	Description
NC	Normally closed	Stands for a normally closed relay contact.
	Not connected	Used in pinout descriptions if a terminal or pin is not connected on the module side.
ND	Not defined	Stands for an undefined value in technical data tables. This may be because the cable manufacturer has not provided a value for certain technical data.
NO	Normally open	Stands for a normally open relay contact.
TBD	To be defined	Used in technical data tables if there is currently no value for specific technical data. The value will be supplied later.
MTBF	Mean time between failures	The expected value of the operating time between two consecutive failures.