

Operating manual

Weather station data logger

HD33[L]MT.4



Companies / Brands of GHM

Members of GHM GROUP:

GREISINGER

HONSBURG

Martens

IMTRON

Delta OHM

VAL.CO

www.deltaohm.com

Keep for future reference.

INDEX

1	INTRODUCTION	3
2	DESCRIPTION	4
3	TECHNICAL CHARACTERISTICS	5
4	INTERNAL CONNECTIONS	8
5	FRONT PANEL	11
6	CONFIGURATION MENU	12
7	SIM CARD	19
8	USB CONNECTION	20
9	HD35AP-S SOFTWARE	20
10	SMS COMMANDS	21
11	TCP/IP CONNECTION VIA MOBILE NETWORK	24
12	MODBUS	25
13	STORAGE OF INSTRUMENTS	40
14	SAFETY INSTRUCTIONS	40
15	ORDERING CODES	41

1 INTRODUCTION

The HD33[L]MT.4 data logger is specifically designed for use in weather stations. Many types of sensors can be connected thanks to its standard terminal header inputs. The data logger is equipped with:

- 4 analog independently configurable inputs (0...50 mV, -50...+50 mV, 0...1 V, 0...10 V, 0...20 mA or 4...20 mA, Pt100, Pt1000, thermocouple, potentiometer, pyrogeometer).
- 2 voltage-free counting contact inputs (e.g. a tipping bucket rain gauge and a cup anemometer can be connected).
- One RS485 port with **Modbus TCP/IP** (via an **optional** module for the connection to an ETHERNET network) or Modbus-RTU protocol, configurable as "Master" or "Slave".
- One SDI-12 "Master" port compatible with version 1.3 of SDI-12 protocol.
- 2 voltage-free contact alarm outputs.

On request, input with M12 connector for relative humidity and temperature with NTC sensor combined probe or, alternatively, for temperature only probe with NTC sensor.

Optional custom LCD display.

Thanks to 4G / 3G / GSM(2G) / GPRS transmission, the user will not have to remove the data logger from its position or reach the place where the data logger is installed to download the data measured with the PC: the instrument can send the data via **e-mail** or **FTP** and can upload the data on an **HTTP** server (**Cloud**, for example the Delta OHM portal "**www.deltaohm.cloud**"). The data logger can be controlled remotely either by sending commands via SMS messages or by establishing a direct TCP/IP connection via mobile network with a remote PC connected to the Internet.

For each detected quantity, the user can set two alarm thresholds (high threshold and low threshold), the alarm hysteresis and a delay in the generation of the alarm. The overrun of the thresholds can be signaled by alarm e-mails or SMS messages. Two voltage-free contact alarm outputs are also available.

HD35AP-S PC software, downloadable free of charge from the Delta OHM website, allows configuration of data logger, displaying measurements in real time both in graphical and numerical format, data download. The data transferred to the PC are entered into a database.

The internal clock of the data logger has high accuracy and is extremely stable in the whole operating temperature range of the instrument. It supports the **automatic time synchronization** with an HTTP reference server.

The **optional** 12 V / 3.4 Ah rechargeable backup battery to be installed inside the case prevents the loss of recordings in case of no external power supply. The battery charger is integrated in the instrument. The data logger can be powered by a solar panel and is designed to be **low power**: can operate for weeks even in absence of battery recharging from the solar panel. Power supply 18...30 Vdc if the rechargeable battery is used or 7...30 Vdc (without ETHERNET module) / 12...30 Vdc (with ETHERNET module) if the rechargeable battery is not used.

A switched power supply output allows powering the sensors only when measurements have to be taken.

IP 65 housing.

2 DESCRIPTION

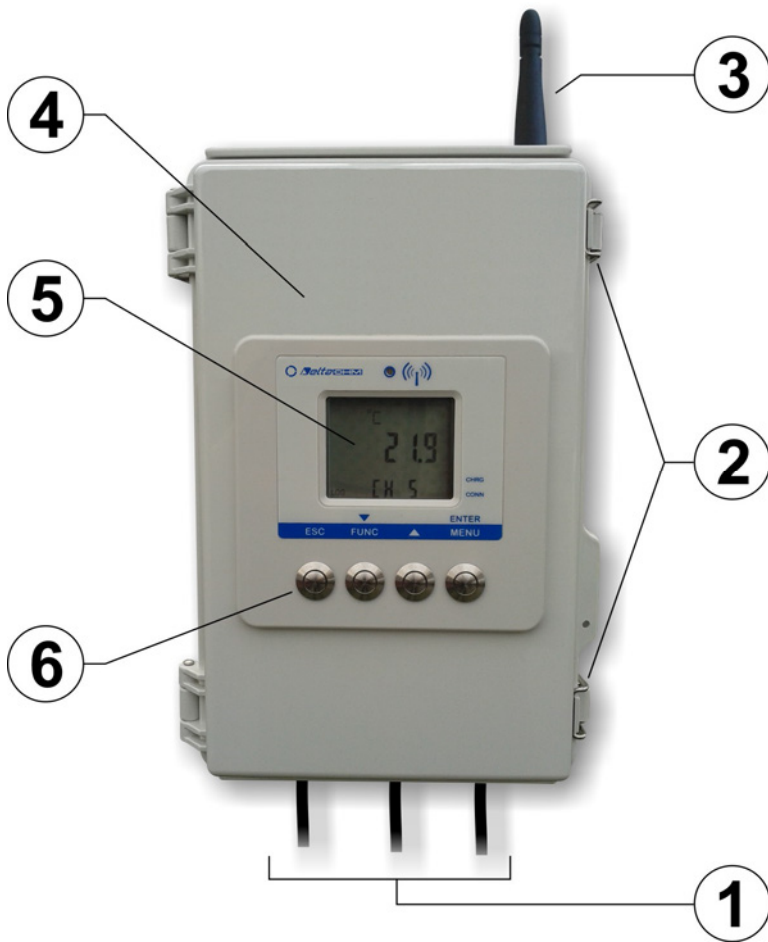

1. Cable glands, connectors and USB port with mini-USB connector
2. Housing closing hooks
3. Antenna
4. Housing cover
5. LCD (optional)
6. Push-buttons
7. Battery (optional)
8. SIM holder
9. Internal terminal header

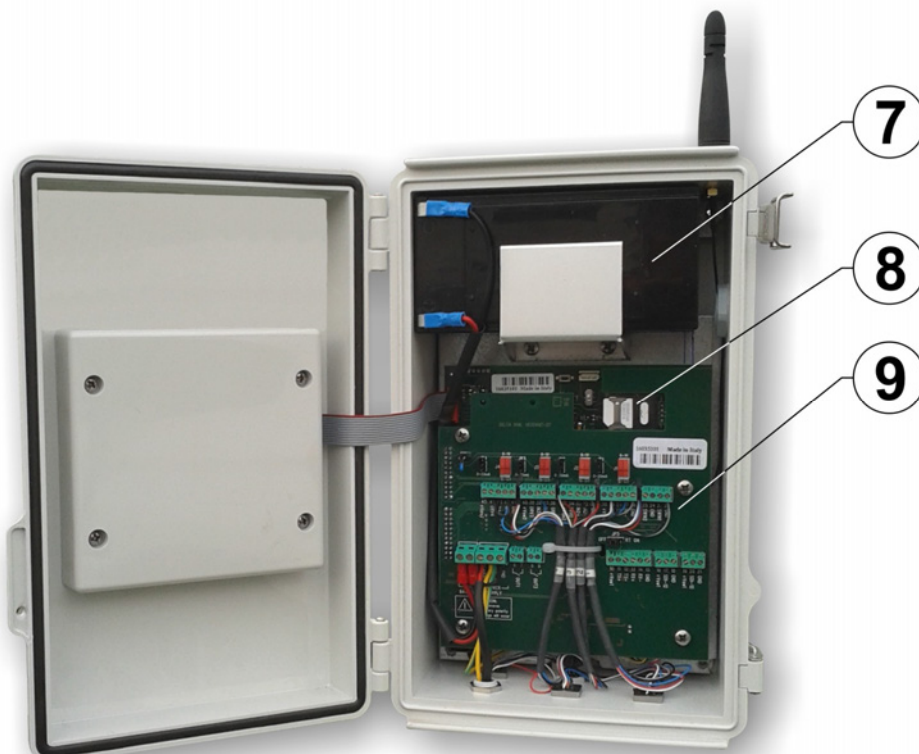

3 TECHNICAL CHARACTERISTICS

<i>Power supply</i>	If the rechargeable battery is used: 18...30 Vdc If the rechargeable battery is not used: 7...30 Vdc without ETHERNET module 12...30 Vdc with ETHERNET module
<i>Power consumption @ 12 Vdc</i>	< 4 mA without ETHERNET module and with no mobile network activity ~ 200 mA with ETHERNET module and with no mobile network activity < 1 A peak during mobile network activity
<i>Battery</i>	Optional internal lead 12 V / 3.4 Ah. Maximum charge current 1 A. The autonomy depends on the number and type of sensors connected.
<i>Switched power supply output</i>	If the data logger is powered by a solar panel (+Vpanel input), the output is equal to the voltage of the internal lead battery (nominal 12 V). If the data logger is powered by the +Vdc input, the output is equal to the voltage of the +Vdc input. The output is active only when the external sensors have to be powered.
<i>Antenna</i>	External
<i>Measuring interval</i>	1, 2, 5, 10, 15, 30 s / 1, 2, 5, 10, 15, 30, 60 min
<i>Logging interval</i>	1, 2, 5, 10, 15, 30 s / 1, 2, 5, 10, 15, 30, 60 min
<i>Internal memory</i>	Circular management or stop logging if memory is full. Number of samples: from 242,850 to 858,070 depending on the number of detected quantities.
<i>Alarm</i>	Sending of alarm e-mail and SMS. Two voltage-free normally open (NO) contact alarm outputs. Max 300 mA @ 30 Vdc resistive charge.
<i>Display</i>	Optional custom LCD
<i>LED indicator</i>	2-color LED: power on (blinks red), mobile network activity (blinks green)
<i>Connection to PC</i>	USB port with mini-USB connector
<i>ETHERNET connection</i>	RJ45 connector (only if the optional ETHERNET module is present)
<i>Internal clock drift</i>	± 2 ppm (0...+40 °C) / ± 5 ppm (-40...+70 °C)
<i>Operating conditions</i>	-40...+70 °C / 0...100 %RH for the version without LCD -20...+70 °C / 0...100 %RH for the version with LCD
<i>Connectors for external probes</i>	M12 connectors or cable glands
<i>Weight</i>	1 kg approx.
<i>Housing</i>	Dimensions: 270 x 170 x 110 mm (excluding external antenna) Material: Polycarbonate (PC) Protection degree: IP 65 (with protective cap on the USB connector)
<i>Installation</i>	Fixing to a 40 mm diameter mast.

Measurement characteristics:

Temperature (instrument in line with the probe HP3517WTC... or TP350NTC...)	
Sensor	NTC 10 k Ω @ 25 °C
Measuring range	-40...+105 °C
Resolution (of instrument)	0.1 °C
Accuracy	± 0.3 °C in the range 0...+70 °C / ± 0.4 °C outside
Stability	0.1 °C / year
Relative Humidity (instrument in line with the probe HP3517WTC ...)	
Sensor	Capacitive
Measuring range	0...100 %RH
Resolution (of instrument)	0.1 %
Accuracy	± 1.8 %RH (0...85 %RH) / ± 2.5 %RH (85...100 %RH) @ T=15...35 °C $\pm (2 + 1.5\%$ measure) $\%$ @ T=remaining range
Sensor operating temperature	-40...+80 °C
Response time	T ₉₀ < 20 s (air speed = 2 m/s, without filter)
Temperature drift	$\pm 2\%$ over the whole operation temperature range
Stability	1% / year
Calculated quantities	Dew Point
<p>For the measurement of relative humidity and temperature, the combined probe HP3517WTC... with NTC 10KΩ @ 25 °C temperature sensor is used, if requested. Alternatively, to the same input can be connected the temperature only probe TP350NTC.... The outdoor installation of the combined temperature and relative humidity probe requires HD9007A-1 or HD9007A-2 protection against solar radiations. Replacement of the humidity probe requires recalibration of the instrument in line with the new probe.</p>	
Atmospheric pressure (optional internal sensor)	
Sensor	Piezoresistive
Measuring range	300...1100 hPa
Resolution (of instrument)	0.1 hPa
Accuracy	± 0.5 hPa (800...1100 hPa) @ T=25°C ± 1 hPa (300...1100 hPa) @ T=0...50°C
Stability	1 hPa / year
Temperature drift	± 3 hPa tra -20...+60 °C
Pt100/Pt1000	
Measuring range	-200...+650 °C
Resolution	0.1 °C
Accuracy	± 0.1 °C (excluding probe error)
Sensor coefficient	$\alpha=0.00385$ °C ⁻¹
Connection	2, 3 or 4 wires
Thermocouple	
Thermocouple type	K, J, T, N, E. The inputs are not isolated, use thermocouples with isolated hot junction.
Measuring range	type K : -200...+1370 °C type J : -100...+750 °C type E : -200...+750 °C type T : -200...+400 °C type N : -200...+1300 °C
Resolution	0.1 °C
Accuracy (excluding probe error)	type K : ± 0.1 °C (< 600 °C) type E : ± 0.1 °C (< 300 °C) ± 0.2 °C (> 600 °C) ± 0.2 °C (> 300 °C) type N : ± 0.1 °C (< 600 °C) type J : ± 0.1 °C ± 0.2 °C (> 600 °C) type T : ± 0.1 °C

0/4...20 mA input	
<i>Shunt resistance</i>	Internal (50 Ω)
<i>Resolution</i>	16 bit
<i>Accuracy</i>	$\pm 2 \mu\text{A}$
Inputs 0...50 mV / -50...50 mV / 0...1 V / 0...10 V	
<i>Input Resistance</i>	100 M Ω
<i>Resolution</i>	16 bit
<i>Accuracy</i>	$\pm 0.01\%$ f.s.
Inputs for counting the switchings of a voltage-free contact	
<i>Switching frequency</i>	50 Hz max.
<i>Hold Time</i>	10 ms min.
Potentiometer input	
<i>Potentiometer</i>	Typically 10 k Ω
<i>Resolution</i>	16 bit
<i>Accuracy</i>	$\pm 0.01\%$ f.s.
Rainfall measurement	
<p>The data logger can record:</p> <ul style="list-style-type: none"> • Maximum rainfall rate • Daily rainfall • Total rainfall • Amount of rainfall which has fallen in the logging interval 	

4 INTERNAL CONNECTIONS

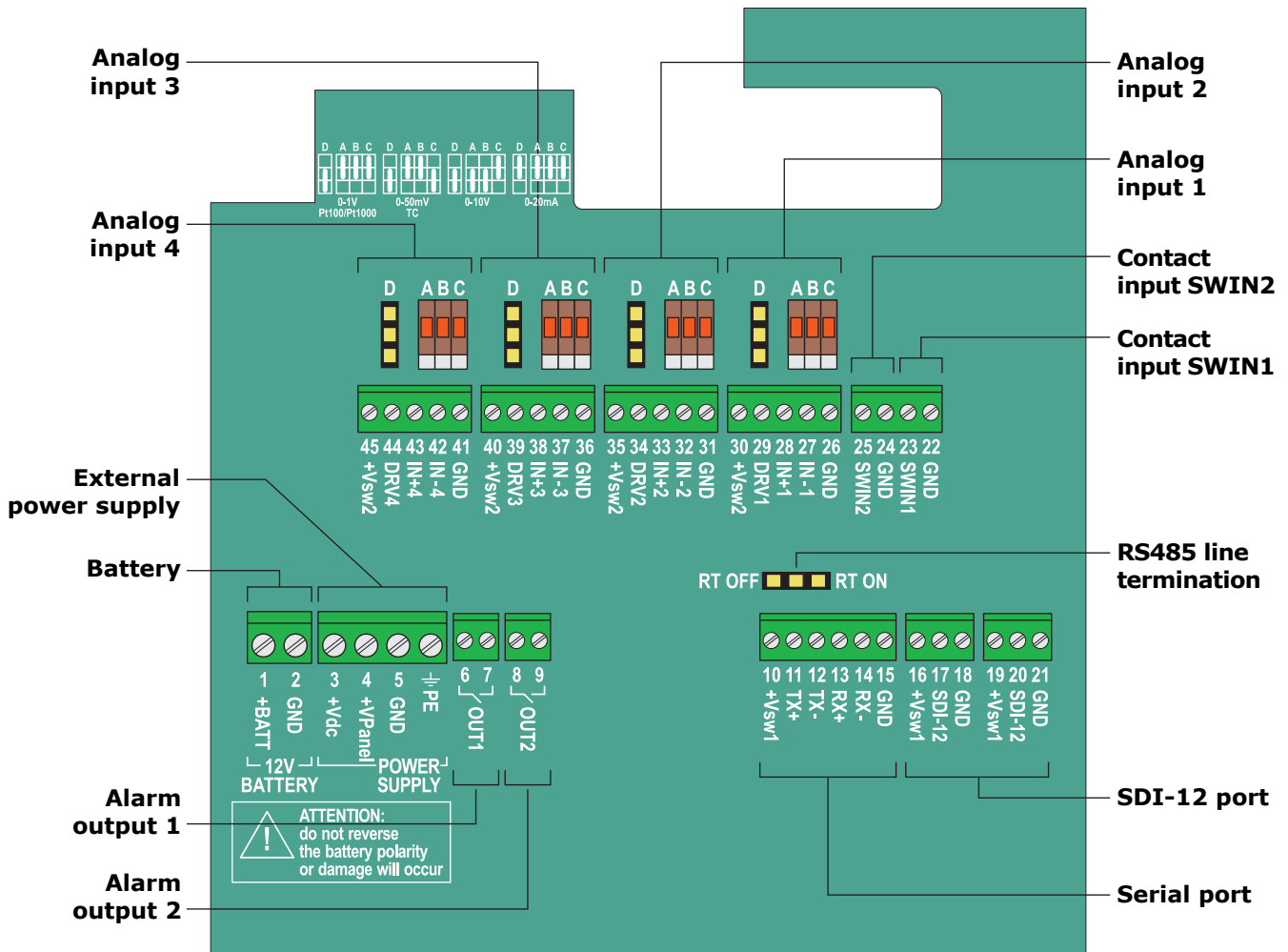

Power supply:

To power the data logger with a solar panel, connect the panel to the +VPanel and GND terminals. To power the data logger with a direct voltage power supply unit, (for example HD32MT.SWD), connect the power supply unit to the +Vdc and GND terminals.

ATTENTION: connect the PE terminal to ground through the cable gland at the bottom of the housing.

If a direct voltage power supply unit is used and the data logger is equipped with a rechargeable lead battery, the battery can be charged by shorting the +Vdc and +Vpanel terminals (provided that +Vdc is within the range 18...27 Vdc).

Analog inputs:

Each analog input can be configured as a Pt100/Pt1000, thermocouple, 0/4...20 mA (shunt resistance inside), 0...50 mV, -50...50 mV, 0...1 V, 0...10 V or potentiometric input. A pyrgometer can also be connected.

The current input accepts any value in the range 0 to 20 mA.

The switched power supply output **+Vsw2** can be used to power the sensors and can be configured as always active, active only during measurements acquisition or always disabled (if only passive sensors are used). When active, it has the same value as the battery voltage if the data logger is powered by a solar panel (+Vpanel input), while it is equal to the voltage of the +Vdc input if the data logger is powered by a direct voltage power supply unit (+Vdc input).

Configuration of inputs is done with the HD35AP-S software.

Below are the connections in the various configurations.

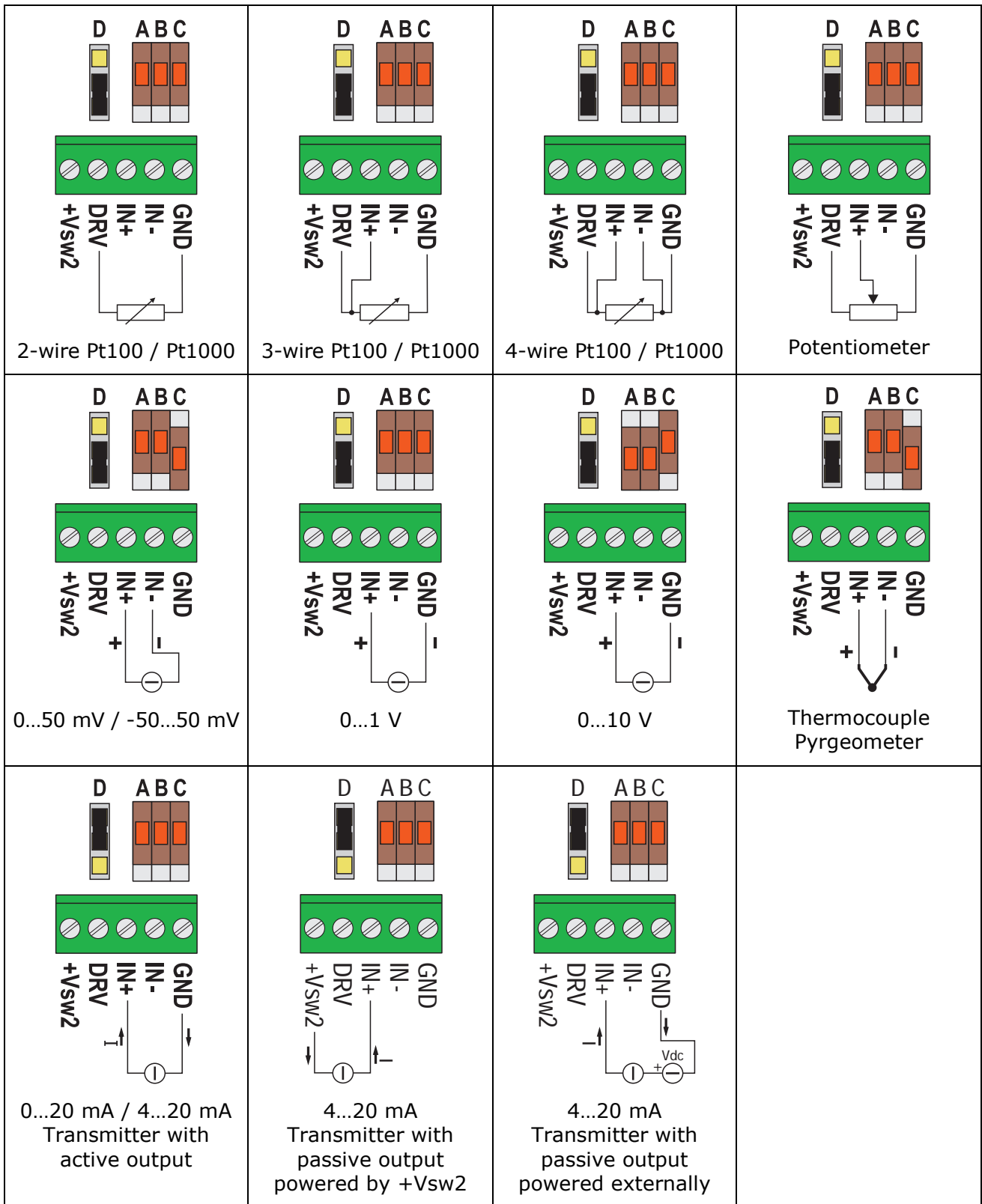

SWIN1 contact input for rain gauge: connect the rain gauge output to the terminals SWIN1 and GND. The rain gauge must be connected to this input to have the calculated quantities (e.g. rainfall rate, ...) available.

SWIN2 contact input: connect the output contact of the sensor between the terminals SWIN2 and GND. The default contact state can be configured: Normally Open (NO) or Normally Closed (NC). The open state is logged as 1, while the closed state is logged as 0. The logged contact state depends on how long the contact remains in the non-default state during the logging interval. If the contact remains in the non-default state for more than a given time (configurable and expressed as a percentage of the logging interval), the non-default state is logged. Vice versa, if the contact remains in the non-default state for less than the set time, the default state is logged.

Example 1: if the contact default state is Normally Open, the logging interval is 30 seconds and the time set for the contact state change is 50% of the logging interval, 0 is logged (contact closed, non-default state) if the contact remains closed for more than 15 seconds during the logging interval, otherwise 1 is logged (contact open, default state).

Example 2: if the contact default state is Normally Closed, the logging interval is 1 minute and the time set for the contact state change is 10% of the logging interval, 1 is logged (contact open, non-default state) if the contact remains open for more than 6 seconds during the logging interval, otherwise 0 is logged (contact closed, default state).

On request, the SWIN2 contact input can be factory set up for connecting a cup anemometer.

Serial port:

In "Master" mode, the port allows reading the measurements of the sensors with RS485 MODBUS-RTU output connected to the data logger serial port. In "Slave" mode, the data logger can communicate the measurements detected by the sensors connected to the other inputs to the "Master" unit of the MODBUS network.

Connect the signals **DATA+** and **DATA -** from the network of sensors to the terminals **TX+** and **TX-** respectively. Connect the ground of the network of sensors to the terminal GND.

Through an **optional** module connected to the serial port, the data logger can be connected to an ETHERNET network and communicate with MODBUS TCP/IP protocol.

The switched power supply output **+Vsw1** can be used to power the sensors and can be configured as always active, active only during measurements acquisition or always disabled. When active, it has the same value as the battery voltage if the data logger is powered by a solar panel (+Vpanel input), while it is equal to the voltage of the +Vdc input if the data logger is powered by a direct voltage power supply unit (+Vdc input).

SDI-12 port: there is only one port, the two SDI-12 inputs are in parallel to facilitate the connection of multiple sensors.

In "Master" mode, the port allows reading the measurements of the sensors with RS485

OUT1 / OUT2 alarm outputs: the instrument is equipped with 2 voltage-free contact alarm outputs that can be handled automatically by the data logger or manually. When handled automatically, the alarm conditions that activate the outputs can be configured by using the HD35AP-S software (see the instructions of the software). When handled manually, the alarm output states can be additionally configured via display and/or SMS commands.

WARNING:

Use the switched power supply output **+Vsw** only to power sensors having a maximum power supply greater or equal to:

- the battery voltage, if the data logger is powered by a solar panel (+Vpanel input);
- the +Vdc input voltage, if the data logger is powered by a direct voltage power supply unit (+Vdc input).

5 FRONT PANEL



1. Bicolor LED: red blinking indicates that the instrument is powered, blinks green to signal the mobile network activity.
2. **ESC** button: exits the selected function.
3. **FUNC/▼** button: in normal operation, it displays the maximum (MAX), the minimum (MIN) and the average (AVG) of the measurements; it scrolls downwards the available options or decreases the set value in the menu.
4. **▲** button: in normal operation, it scrolls the quantities measured by the data logger; it scrolls upwards the available options or decreases the set value in the menu.
5. **MENU/ENTER** button: allows access to the configuration menu; confirm the selected option or the set value in the menu.

Manual reset of the statistical values (MAX, MIN, AVG):

- 1) In measurement mode, press **FUNC** until the reset request appears.
Note: the reset request appears only if the manual reset, not the daily automatic reset, is enabled.
- 2) Select Yes by using the **▲** button.
- 3) Press **ENTER**.

6 CONFIGURATION MENU

The menu allows displaying the data logger information and changing operation parameters. The menu is structured in levels, with main categories and submenus.

To access the menu you need to enter the **user password** (configurable through the appropriate menu item) or the **administrator password** (supplied with the system and not editable). Entering the user password makes some settings not changeable.

The instrument exits automatically the menu if no key is pressed for 3 minutes. After exiting the menu, the password remains active for a few minutes, during which you may enter the menu again without re-entering the password. It is possible to exit the menu by disabling immediately the password by performing a password level reset in the *Password* menu.

To access a menu parameter proceed as follows:

1. Press **MENU**, the first digit of the password will blink.
2. Using ∇/\blacktriangle keys, set the first digit and confirm with **ENTER**, the second digit of the password will blink. Set all the password digits in the same way.
3. Using ∇/\blacktriangle keys, select a main category in the menu and confirm with **ENTER**. Menu items appear one at a time in the upper part of the display; the lower part of the display shows the position of the item in the menu and the total number of items in the menu (for ex. "8 - 12" means the eighth item in a menu of 12 items).

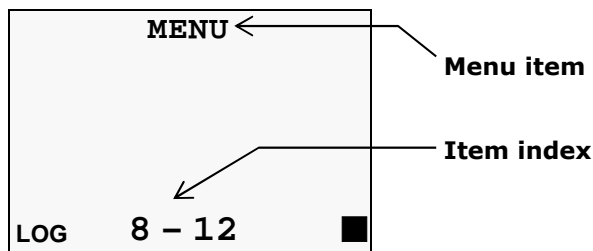

4. If the selected main category has a submenu, select the desired item using ∇/\blacktriangle keys and confirm with **ENTER**. Scrolling the submenus displays also the parameter current setting.
5. To change the selected parameter, if allowed, use ∇/\blacktriangle keys to select the desired setting and confirm with **ENTER**. If you are setting a numeric value, you can fast forward by keeping ∇ or \blacktriangle keys depressed.

To exit the main menu or a sub menu, select EXIT item (last menu item) or press ESC key.

If it is not allowed to change a parameter, the notice N/A (Not Available) will appear when pressing ENTER to select it.

Menu structure

The complete structure of the main menu with the relevant submenus is shown below.

1) DEV_INFO (information)

It lists the general information of the instrument: model, serial number, user code, group name, firmware version, calibration date, etc. Information is shown in the upper part of the display.

2) FUNC_MENU (statistics reset mode and test mode)

- 1) **FUNC_RST_MODE**: statistical info (MAX, MIN, AVG) reset mode. Select 0 (*MAN_RST*) for the manual reset; select 1 (*AUTO_RST*) for the daily automatical reset at 6 am.
- 2) **TEST_MODE**: enables or disables the test mode. Select *On* to activate the test mode. In test mode, the instrument temporarily suspends the logging activities and the calculation of the integral and statistical functions until the test mode is exited. The instrument automatically exits the test mode after 1 hour.

- 3) **LOW_BATT_PROT**: enables or disables the battery protection against excessive discharge. Selecting *ON*, when the battery voltage falls below the configured threshold (see the following menu item *LOW_BATT_THLD_V*) the high-consumption activities of the data logger are disabled: mobile communication, communication with digital buses (RS485 and SDI-12), power supply of active sensors, relays. Instead, the instrument continues to measure and store passive sensor data. When the battery voltage returns above the threshold, all functions are automatically reactivated.
- 4) **LOW_BATT_THLD_V**: battery protection threshold against excessive discharge (default = 10.90 V).
- 5) **EXIT**: returns to the main menu.

3) RELY_MENU (relay settings)

- 1) **RELY_ONE_MODE**: relay "one" functioning mode. Select *0 (AUTO_MODE)* to enable the data logger automatic relay control as a function of the measurement alarm thresholds and other alarm conditions; select *1 (MAN_MODE)* to control the relay status manually.
- 2) **RELY_ONE_STAT**: Reset or set relay "one" status when relay "one" is handled manually. Select *Off/On* to respectively reset/set relay status.
- 3) **RELY_TWO_MODE**: relay "two" functioning mode. Select *0 (AUTO_MODE)* to enable the data logger automatic relay control as a function of the measurement alarm thresholds and other alarm conditions; select *1 (MAN_MODE)* to control relay status manually.
- 4) **RELY_TWO_STAT**: Reset or set relay "two" status when relay "two" is handled manually. Select *Off/On* to respectively reset/set relay status.
- 5) **EXIT**: returns to the main menu.

4) GSM_MENU (mobile network settings)

- 1) **SMS_ALARM**: enables or disables the alarm via SMS. Select *On* to enable the sending of alarm SMSes.
- 2) **EML_ALARM**: enables or disables the alarm via e-mail. Select *On* to enable the sending of alarm e-mails.
- 3) **EML_DATA_TX**: enables or disables the periodic sending of data via e-mail. Select *On* to enable the sending of data via e-mails.
- 4) **EML_DATA_TX_TIME**: e-mail data sending interval.
 - 1 (*REAL TIME*): immediately after logging
 - 0 (*15 min*): every 15 minutes
 - 1 (*30 min*): every 30 minutes
 - 2 (*1 h*): every hour
 - 3 (*2 h*): every 2 hours
 - 4 (*4 h*): every 4 hours
 - 5 (*8 h*): every 8 hours
 - 6 (*12 h*): every 12 hours
 - 7 (*1 d*): once a day
 - 8 (*2 d*): every 2 days
 - 9 (*4 d*): every 4 days
 - 10 (*1 w*): once a week
 - 11 (*1 min*): every minute
 - 12 (*5 min*): every 5 minutes
 - 13 (*10 min*): every 10 minutes

- 5) **EML_DATA_TX_MODE**: format of the data sent via e-mail.
 - 0 (LOG): only internal LOG format (for database)
 - 1 (CSV): only standard CSV format (for Excel®)
 - 2 (LOG+CSV): both internal LOG and standard CSV formats
- 6) **FTP_DATA_TX**: enables or disables the periodic sending of data via FTP. Select *On* to enable the sending of data via FTP.
- 7) **FTP_DATA_TX_TIME**: FTP data sending interval.
See the item *EML_DATA_TX_TIME* above for the available intervals.
- 8) **FTP_DATA_TX_MODE**: format of the data sent via FTP.
See the item *EML_DATA_TX_MODE* above for the available formats.
- 9) **HTTP_DATA_TX**: enables or disables the periodic sending of data via HTTP. Select *On* to enable the sending of data via HTTP.
- 10) **HTTP_DATA_TX_TIME**: HTTP data sending interval.
See the item *EML_DATA_TX_TIME* above for the available intervals.
- 11) **EXIT**: returns to the main menu.

5) THLD_MENU (alarm thresholds)

Note: the menu items depend on the data logger configuration.

- 1) **CH1_Input Type_DOWN_THLD**: lower alarm threshold of the quantity measured by the analog input 1.
- 2) **CH1_Input Type_UP_THLD**: higher alarm threshold of the quantity measured by the analog input 1.
- 3) **CH2_Input Type_DOWN_THLD**: lower alarm threshold of the quantity measured by the analog input 2.
- 4) **CH2_Input Type_UP_THLD**: higher alarm threshold of the quantity measured by the analog input 2.
- 5) **CH3_Input Type_DOWN_THLD**: lower alarm threshold of the quantity measured by the analog input 3.
- 6) **CH3_Input Type_UP_THLD**: higher alarm threshold of the quantity measured by the analog input 3.
- 7) **CH4_Input Type_DOWN_THLD**: lower alarm threshold of the quantity measured by the analog input 4.
- 8) **CH4_Input Type_UP_THLD**: higher alarm threshold of the quantity measured by the analog input 4.
- 9) **ATM_PRES_DOWN_THLD_unit**: lower alarm threshold of the atmospheric pressure (optional) in the set unit of measurement.
- 10) **ATM_PRES_UP_THLD_unit**: higher alarm threshold of the atmospheric pressure (optional) in the set unit of measurement.
- 11) **BATT_DOWN_THLD_V**: lower alarm threshold of the battery voltage in V.
- 12) **BATT_UP_THLD_V**: higher alarm threshold of the battery voltage in V.
- 13) **VOLT_PWR_SPLY_DOWN_THLD_V**: lower alarm threshold of the external power supply in V.
- 14) **VOLT_PWR_SPLY_UP_THLD_V**: higher alarm threshold of the external power supply in V.
- 15) **MAX_RAIN_RATE_DOWN_THLD_unit**: lower alarm threshold of the rainfall rate in the set unit of measurement.
- 16) **MAX_RAIN_RATE_UP_THLD_unit**: higher alarm threshold of the rainfall rate in the set unit of measurement.
- 17) **CURR_RAIN_DOWN_THLD_unit**: lower alarm threshold of the rainfall quantity in the set unit of measurement.

- 18) **CURR_RAIN_UP_THLD_unit**: higher alarm threshold of the rainfall quantity in the set unit of measurement.
- 19) **THLD_ALARM**: enables or disables the buzzer when measurement thresholds are exceeded.
- 20) **EXIT**: returns to the main menu.

6) HYST_MENU (hysteresis of the alarm thresholds)

Note: the menu items depend on the data logger configuration.

- 1) **CH1_Input Type_HYST%**: hysteresis of the alarm thresholds of the quantity measured by the analog input 1.
- 2) **CH2_Input Type_HYST%**: hysteresis of the alarm thresholds of the quantity measured by the analog input 2.
- 3) **CH3_Input Type_HYST%**: hysteresis of the alarm thresholds of the quantity measured by the analog input 3.
- 4) **CH4_Input Type_HYST%**: hysteresis of the alarm thresholds of the quantity measured by the analog input 4.
- 5) **ATM_PRES_HYST%**: hysteresis of the alarm thresholds of the atmospheric pressure (optional).
- 6) **BATT_HYST%**: hysteresis of the alarm thresholds of the battery voltage.
- 7) **VOLT_PWR_SPLY_HYST%**: hysteresis of the alarm thresholds of the external power supply.
- 8) **MAX_RAIN_RATE_HYST%**: hysteresis of the alarm thresholds of the rainfall rate.
- 9) **CURR_RAIN_HYST%**: hysteresis of the alarm thresholds of the rainfall quantity.
- 10) **EXIT**: returns to the main menu.

The width of the hysteresis is a percentage (0 ... 100%) of the difference between the two alarm thresholds.

For example, if Hysteresis=2%, Lower threshold=10 °C and Upper threshold=60 °C, the hysteresis is $(60-10) \times 2 / 100 = 1$ °C:

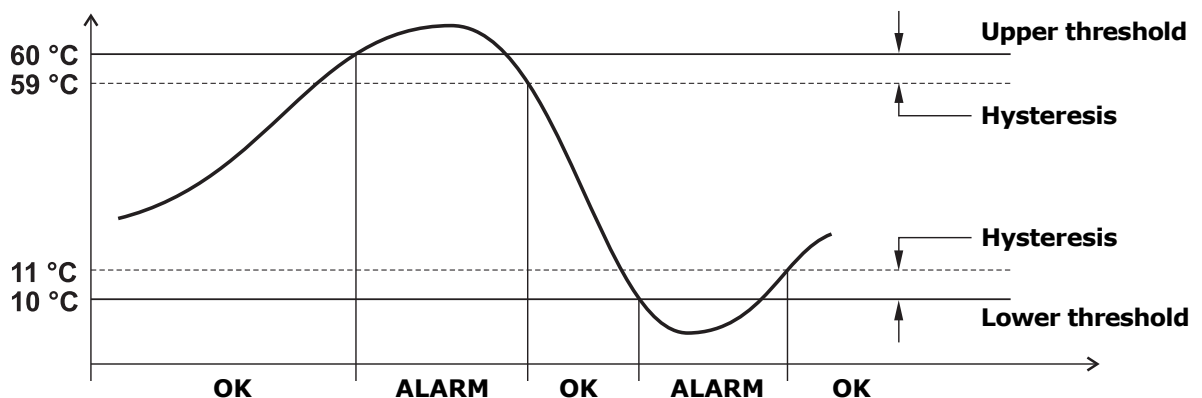

7) ALRM_DELY_MENU (delay, in seconds, for alarm activation)

Note: the menu items depend on the data logger configuration.

- 1) **CH1_Input Type_ALARM_DELY**: delay for alarm activation of the quantity measured by the analog input 1.
- 2) **CH2_Input Type_ALARM_DELY**: delay for alarm activation of the quantity measured by the analog input 2.
- 3) **CH3_Input Type_ALARM_DELY**: delay for alarm activation of the quantity measured by the analog input 3.

- 4) **CH4_Input_Type_ALARM_DELY**: delay for alarm activation of the quantity measured by the analog input 4.
- 5) **ATM_PRES_ALARM_DELY**: delay for alarm activation of the atmospheric pressure (optional).
- 6) **BATT_ALARM_DELY**: delay for alarm activation of the battery voltage.
- 7) **VOLT_PWR_SPLY_ALARM_DELY**: delay for alarm activation of the external power supply.
- 8) **MAX_RAIN_RATE_ALARM_DELY**: delay for alarm activation of the rainfall rate.
- 9) **CURR_RAIN_ALARM_DELY**: delay for alarm activation of the rainfall quantity.
- 10) **EXIT**: returns to the main menu.

If the measured value drops below the lower threshold or exceeds the upper threshold, the alarm is generated after the time set. The alarm is generated immediately if 0 is set. If the alarm condition ends before the delay time is elapsed, the alarm is not generated.

8) MEAS_UNIT_MENU (measurement unit)

- 1) **TEMP_UNIT_MEAS**: temperature unit of measurement.
 - 0 (°C)
 - 1 (°F)
- 2) **PRES_UNIT_MEAS**: atmospheric pressure (optional) unit of measurement.
 - 0 (mbar)
 - 1 (bar)
 - 2 (Pa)
 - 3 (hPa)
 - 4 (kPa)
 - 5 (atm)
 - 6 (mmHg)
 - 7 (mmH₂O)
 - 8 (inHg)
 - 9 (inH₂O)
 - 10 (kgf/cm²)
 - 11 (PSI)
- 3) **WIND_SPEED_UNIT_MEAS**: wind speed unit of measurement.
 - 0 (m/s)
 - 1 (km/h)
 - 2 (ft/s)
 - 3 (mph)
 - 4 (knot)
- 4) **RAIN_UNIT_MEAS**: rainfall quantity unit of measurement.
 - 0 (mm)
 - 1 (inches)
 - 2 (counts)
- 5) **EXIT**: returns to the main menu.

9) LOG_MENU (logging)

- 1) **LOG_STAT**: enables or disables the logging.
- 2) **LOG_CYCL**: choice between cyclical management (the new data overwrite the old ones when the memory is full) or non-cyclical management (logging stops when the memory is full) of the data logger memory. Select *YES* for the cyclical management.
- 3) **LOG_TIME**: choice of logging interval. If it is higher than the measuring interval, the average of the measurements acquired during the interval will be stored (except for the measurements for which the average is meaningless; e.g., the maximum rainfall rate, the total rainfall, etc.).
- 4) **MEAS_TIME**: choice of the measurements acquisition interval. It is forced to the value *LOG_TIME* if a higher value is set.
- 5) **LOG_DEL**: deletes all stored measurements from the data logger memory. Select *YES* to delete the memory.
- 6) **EXIT**: returns to the main menu.

10) MOD_BUS_MENU (Modbus)

- 1) **MOD_BUS_ADDR**: Modbus address.
- 2) **MOD_BUS_BAUD_RATE_kbps**: RS485 baud rate in kbps (9.6 / 19.2 / 38.4 / 57.6 / 115.2).
- 3) **MOD_BUS_MODE**: RS485 communication mode (8N1 / 8N2 / 8E1 / 8E2 / 8O1 / 8O2).
- 4) **WAIT_3_5_CHAR_AFTR_TX**: setting of the waiting time after transmission with Modbus protocol (*YES*=respect protocol and wait 3.5 characters after transmission / *nO*=violate protocol and go in receiving mode right after transmission).
- 5) **MOD_BUS_SLV_PSW_STAT**: enabling of the password for changing the configuration via Modbus. Select *On* to enable the password.
- 6) **MOD_BUS_MSTR_/SLV_CONF**: setting of the "Master" or "Slave" Modbus mode. Select *0* for "Master" mode or *1* for "Slave" mode.
- 7) **EXIT**: returns to the main menu.

11) CLK_MENU (clock)

- 1) **YEAR**: year.
- 2) **MON**: month.
- 3) **DAY**: day.
- 4) **HOUR**: hour.
- 5) **MIN**: minutes.
- 6) **AUTO_TIME_SYNC**: enables or disables the automatic synchronization of the internal clock with a reference server. Select *On* to activate the automatic synchronization.
- 7) **AUTO_TIME_ZONE**: enables or disables the automatic setting of the time zone. Select *On* to activate the automatic setting.
- 8) **TIME_ZONE**: manual setting of the time zone.
- 9) **EXIT**: returns to the main menu.

12) PSW_MENU (password)

- 1) **RST_PSW_LVL**: exits the menu and deactivates immediately the password (the password will not remain active for some minutes as it normally happens when exiting the menu: you will need to re-enter the password even if you re-access immediately the menu).
- 2) **SET_NEW_PSW**: sets user-level password.
- 3) **EXIT**: returns to the main menu.

13) CAL_MENU (calibration) – *Only available with administrator password*

Note: the availability of the menu items depends on the data logger configuration.

- 1) **RH_75%_CAL**: relative humidity sensor calibration at 75%RH.
- 2) **RH_33%_CAL**: relative humidity sensor calibration at 33%RH.
- 3) **RAIN_TIP_mm**: tipping bucket rain gauge resolution in mm.
- 4) **RST_ALL_RAIN_CNTRS**: reset of all the rainfall counters. Select *YES* to reset the counters.
- 5) **CONT_INP_DFLT_STAT**: setting of the default state of the SWIN2 contact input as Normally Open (NO) or Normally Closed (NC).
- 6) **dt%_CONT_INP_STAT_CHNG**: setting of the time required to accept the state change of the SWIN2 contact, expressed as a percentage of the logging interval.
- 7) **CAL_TYPE**: choice between user calibration (*USER*) or factory calibration (*FACT*).
- 8) **EXIT**: returns to the main menu.

14) EXIT

Returns to measurement mode.

7 SIM CARD

In order to use the mobile network functionalities, a **SIM** card enabled for data transmission must be inserted into the data logger. The card should be requested to an operator that has an adequate coverage of the mobile network in the place where the data logger will be installed. To insert the card, proceed as follows.

1. Disconnect the power supply.
2. Open the housing.
3. Push the metal block of the SIM tray in the direction of the arrow OPEN, and rotate the tray upward.

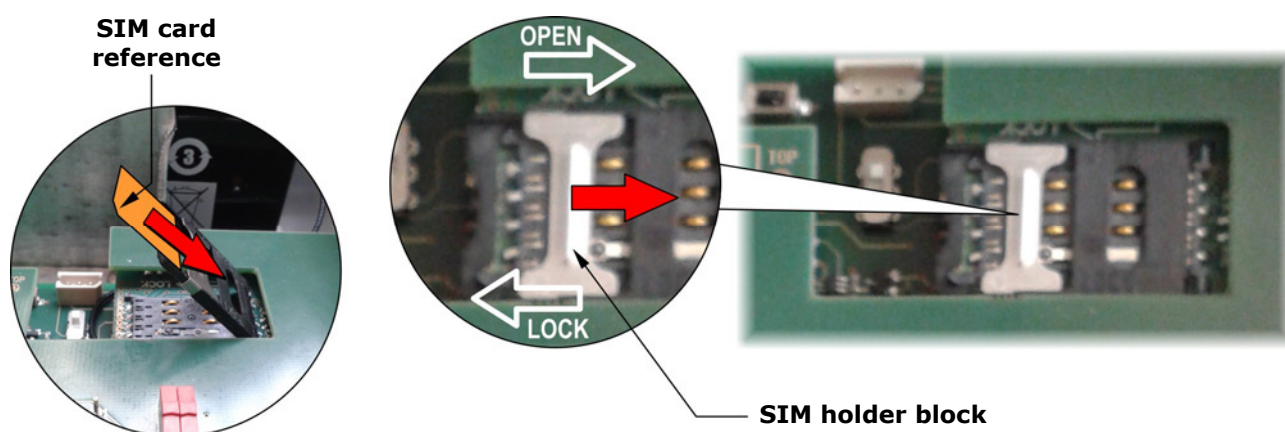

4. Insert the SIM card into its tray so as the SIM card contacts face down and correspond to the contacts on the electronic board. The SIM has to be inserted between the metal block and the plastic part.
5. Put the SIM tray back in place and push the metal block in the direction of the arrow LOCK.
6. Close the housing.

Through the HD35AP-S software, set the necessary information for mobile network operation: SIM PIN, name of the APN access point, e-mail account and addresses, FTP address, telephone numbers, data transmission mode, etc. (see section "Mobile network settings" of the software online help).

Note: the switch located on the left of the SIM card must be set upwards. The downwards position and the PWRKEY button are used to update the firmware of the mobile communication module.

The connection symbol (CONN) on the display is ON when the instrument is connected to the mobile network (the symbol blinks while connecting).

Among the information that you can scroll on display with the button in the lower part of the data logger, there is also the strength RSSI (Received Signal Strength Indication) in dBm of the mobile network signal received.

8 USB CONNECTION

The data logger can be connected to a PC through the mini-USB connector located at the bottom of the housing. Remove the connector protective cap and connect the **CP23** cable.

USB connection doesn't require the installation of drivers: when the data logger is connected to a PC, Windows® operating system automatically recognizes the instrument as an HID device (Human Interface Device) and uses the drivers already included in the operating system.

The data logger must be powered separately, it is not powered by the PC USB port.

When the data logger is not connected to the PC, replace the mini-USB connector protective cap to ensure the watertight integrity of the instrument.

9 HD35AP-S SOFTWARE

The HD35AP-S software, downloadable free of charge from the Delta OHM website, allows:

- Configuring the data logger: measurements to be displayed, alarm thresholds and hystereses, logging and transmitting intervals, date and time, etc. (see chapters "HD35ED... data loggers configuration", "Alarms configuration", "GSM/3G/4G settings" and "Clock setting" of the software online help).
- Transferring stored data to PC (see chapters "Data download" and "Data download from FTP" of the software online help).
- Displaying measurements in real time, also in graphic format (see chapter "Monitor" of the software online help).
- Managing the graphical representation, print and export of acquired data (see chapter "Displaying data in the database" of the software online help).
- Calibrating the sensors (see chapter "Calibration" of the software online help).

For the connection of the data logger to the HD35AP-S software see chapter "Connection" of the software online help.

10 SMS COMMANDS

SMS messages containing commands can be sent by a mobile phone to the data logger. The SMS must be sent to the number of the SIM card inserted into the data logger. The following table lists the available commands:

Command	Description
RESET	Reset of the device
EMAIL-ON	Activates periodic download of measurement data via e-mail
EMAIL-OFF	Deactivates periodic download of measurement data via e-mail
EMAIL-PERIOD= <i>period index</i>	Set the transmission interval via e-mail, where <i>period index</i> : -1→Real time, 0→15 min, 1→30 min, 2→1 hour, 3→2 hours, 4→4 hours, 5→8 hours, 6→12 hours, 7→24 hours, 8→2 days, 9→4 days, 10→1 week 11→1 min, 12→5 min, 13→10 min
EMAIL-FORMAT= <i>format index</i>	Set the format of the data sent via e-mail, where <i>format index</i> : 1→log (format for database), 2→csv (format for Excel®), 3→log+csv
EMAIL-DL-START	Activates immediate data download via e-mail starting from the last measurement transmitted
EMAIL-DL-FROM= YYYY/MM/DD HH:MM:SS	Downloads data via e-mail starting from the specified date, where YYYY: year, MM: month, DD: day, HH: hour, MM: minutes, SS: seconds
EMAIL-DL-INTERVAL= YYYY/MM/DD HH:MM:SS - YYYY/MM/DD HH:MM:SS	Downloads via e-mail all data between the specified dates, where YYYY: year, MM: month, DD: day, HH: hour, MM: minutes, SS: seconds
EMAIL-ALARM-REPORT	Transmits via e-mail a report containing the measurements that can generate alarms
EMAIL-REPORT	Transmits via e-mail a report containing the current measurements
EMAIL-HELP	Transmits an e-mail containing a list of all SMS commands
FTP-ON	Activates the periodic download of measurement data via FTP
FTP-OFF	Deactivates the periodic download of measurement data via FTP
FTP-PERIOD= <i>period index</i>	Set the transmission interval via FTP, where <i>period index</i> : -1→Real time, 0→15 min, 1→30 min, 2→1 hour, 3→2 hours, 4→4 hours, 5→8 hours, 6→12 hours, 7→24 hours, 8→2 days, 9→4 days, 10→1 week 11→1 min, 12→5 min, 13→10 min
FTP-FORMAT= <i>format index</i>	Set the format of the data sent via FTP, where <i>format index</i> : 1→log (format for database), 2→csv (format for Excel®), 3→log+csv
FTP-DL-START	Activates immediate data download via FTP starting from the last measurement transmitted
FTP-DL-FROM= YYYY/MM/DD HH:MM:SS	Downloads data via FTP starting from the specified date, where YYYY: year, MM: month, DD: day, HH: hour, MM: minutes, SS: seconds
FTP-DL-INTERVAL= YYYY/MM/DD HH:MM:SS - YYYY/MM/DD HH:MM:SS	Downloads via FTP all data between the specified dates, where YYYY: year, MM: month, DD: day, HH: hour, MM: minutes, SS: seconds
FTP-ALARM-REPORT	Transmits via FTP a report containing the measurements that can generate alarms
FTP-REPORT	Transmits via FTP a report containing the current measurements
FTP-HELP	Transmits via FTP a file containing a list of all SMS commands
SMS-ALARM-ON	Activates the transmission of alarm SMS for the overrun of the measurement thresholds (if the device is selected for sending alarm SMS)
SMS-ALARM-OFF	Deactivates the transmission of alarm SMS for the overrun of the measurement thresholds for the selected devices
EMAIL-ALARM-ON	Activates the transmission of e-mail measurements alarms (if the device is selected for sending alarm e-mail)
EMAIL-ALARM-OFF	Deactivates the transmission of e-mail alarms for measurement alarms
SMS-ALARM-REPORT	Indicates whether the measurements are in alarm. Only the selected measurements are taken into consideration for SMS alarms

Command	Description
SMS-DEVICE-ALARM-REPORT	Transmits via SMS a report of the measurements selected for SMS alarms
SMS-DEVICE-REPORT	Transmits via SMS a report of the measurements of the device
SMS-HELP	Transmits an SMS containing the list of all SMS commands
TCP-SERVER-ON	Activates a TCP connection with AP acting as a TCP server
TCP-SERVER-OFF	Deactivates the TCP connection with the device acting as a TCP server
TCP-CLIENT-ON	Activates a TCP connection with the device acting as a TCP client
TCP-CLIENT-OFF	Deactivate the TCP connection with the device acting as a TCP client
TCP-SERVER-ADDRESS="server address"	Specifies the server address for TCP connection when the device acts as TCP client. The server-address string can be a domain or a IP address
TCP-SERVER-PORT=port number	Specifies the number of the TCP port used by the remote server to accept connections with the device when the device acts as TCP client
TCP-LISTEN-PORT=port number	Specifies the number of the TCP listening port used by the device when the device acts as TCP server
HTTP-ON	Activates the periodic upload of measurement data on the HTTP server
HTTP-OFF	Deactivates the periodic upload of measurement data on the HTTP server
HTTP-PERIOD= period index	Set the transmission interval via HTTP, where <i>period index</i> : -1⇒Real time, 0⇒15 min, 1⇒30 min, 2⇒1 hour, 3⇒2 hours, 4⇒4 hours, 5⇒8 hours, 6⇒12 hours, 7⇒24 hours, 8⇒2 days, 9⇒4 days, 10⇒1 week 11⇒1 min, 12⇒5 min, 13⇒10 min
HTTP-DL-START	Activates immediate data upload on the HTTP server starting from the last measurement transmitted
HTTP-DL-FROM=YYYY/MM/DD HH:MM:SS	Uploads data on the HTTP server starting from the specified date, where YYYY: year, MM: month, DD: day, HH: hour, MM: minutes, SS: seconds
HTTP-DL-INTERVAL=YYYY/MM/DD HH:MM:SS - YYYY/MM/DD HH:MM:SS	Uploads on the HTTP server all data between the specified dates, where YYYY: year, MM: month, DD: day, HH: hour, MM: minutes, SS: seconds
ADD-PHONE="phone number"	Adds a phone number to the list of numbers considered for SMS alarms
CANC-PHONE	Delete my phone number and don't consider it any more for SMS alarms. The primary phone number cannot be deleted
ERASE-PHONE=phone number index	Deletes the phone number with specified index. This command is accepted only by the primary phone number
RELAY-1-AUTO	Set relay 1 to be handled automatically
RELAY-1-MANUAL	Set relay 1 to be handled manually
RELAY-1-RESET	Reset relay 1 status when the relay is handled manually
RELAY-1-SET	Set relay 1 status when the relay is handled manually
RELAY-2-AUTO	Set relay 2 to be handled automatically
RELAY-2-MANUAL	Set relay 2 to be handled manually
RELAY-2-RESET	Reset relay 2 status when the relay is handled manually
RELAY-2-SET	Set relay 2 status when the relay is handled manually
MEASURE-INTERVAL=interval index	Set the measuring interval, where <i>interval index</i> : 0⇒1 s, 1⇒2 s, 2⇒5 s, 3⇒10 s, 4⇒15 s, 5⇒30 s, 6⇒1 min, 7⇒2 min, 8⇒5 min, 9⇒10 min, 10⇒15 min, 11⇒30 min, 12⇒1 hour
LOG-INTERVAL= interval index	Set the logging interval, where <i>interval index</i> : 0⇒1 s, 1⇒2 s, 2⇒5 s, 3⇒10 s, 4⇒15 s, 5⇒30 s, 6⇒1 min, 7⇒2 min, 8⇒5 min, 9⇒10 min, 10⇒15 min, 11⇒30 min, 12⇒1 hour

Up to 16 commands can be written in the same text message, separated by spaces or commas.

For safety, commands are executed only if they are coming from the cell numbers set in the HD35AP-S software and if the SMS text starts with a user-defined key word. The key word is set through the HD35AP-S software, going to the menu "GSM options" at the item "SMS

recipients " and setting the field " *SMS keyword* " (see chapter " *GSM settings* " of the software online help).

Example: supposing you entered the string ">>>" in the *SMS keyword* field and you wish to activate periodic download via e-mail of the measured data with an interval of 1 hour, you will have to send the following text message:

>>> EMAIL-ON EMAIL-PERIOD=2

With the commands EMAIL-HELP, FTP-HELP and SMS-HELP you can ask the base unit to send respectively by e-mail, to an FTP address and through SMS the complete list of the available SMS commands.

11 TCP/IP CONNECTION VIA MOBILE NETWORK

It is possible to interact with the data logger by establishing a direct TCP/IP connection via mobile network with a remote PC connected to the Internet.

The connection can be of two types:

1) **Data Logger = Client , PC = Server**

The data logger acts as TCP client and requests the connection to the PC, the PC acts as TCP server and waits for the connection request. The server IP address (PC or Router) must be public and can be either static or dynamic; if the IP address is dynamic, it is convenient to register the server to a DDNS (Dynamic Domain Name System) service.

2) **Data Logger = Server , PC = Client**

The PC acts as TCP client and requests the connection to the data logger, the data logger acts as TCP server and waits for the connection request. The server IP address (data logger) must be public and static.

Connection Data Logger = Client , PC = Server

1. Open a port (port forwarding) in the Modem/Router through which your PC connects to Internet (follow the instructions of your Modem/Router).
2. Connect the data logger to a PC USB port and perform the connection procedure with the HD35AP-S software.
3. In the HD35AP-S software select *Instruments setup >> GSM options >> GPRS TCP/IP client settings* and set the server IP address or domain name and port number (number of the port opened in the Modem/Router).
4. Disconnect the data logger from the USB port.
5. In the HD35AP-S software select *Tools >> Type of connection*, select the *TCP server* option and set the number of the port opened in the Modem/Router.
6. In the HD35AP-S software, select the *Connect* icon.
7. Send to the data logger the SMS command **TCP-CLIENT-ON**.

If the connection is not established within 30 minutes after sending the SMS command TCP-CLIENT-ON, the command must be sent again.

Alternatively, the server IP address or domain name and port number can be set in the data logger without connecting the data logger to the PC and without the HD35AP-S software by using the SMS commands **TCP-SERVER-ADDRESS** and **TCP-SERVER-PORT**.

Connection Data Logger = Server , PC = Client

1. Open a listening port in the data logger by using the SMS command **TCP-LISTEN-PORT** (for example, TCP-LISTEN-PORT=2020).
2. Send to the data logger the SMS command **TCP-SERVER-ON**.
3. The data logger replies with a first SMS to confirm that the command has been accepted. Wait for a second SMS with the confirmation that the *TCP server* functionality has been activated and with the IP address (and port number) assigned to the data logger.
4. In the HD35AP-S software select *Tools >> Type of connection*, select the *TCP client* option and set the IP address and port number of the datalogger.
5. In the HD35AP-S software, select the *Connect* icon.

If the connection is not established within 1 hour after sending the SMS command TCP-SERVER-ON, the command must be sent again.

12 MODBUS

The complete list of MODBUS registers for "Slave" mode is shown below. Depending on the system configuration, some of the listed registers could not be present if not significant for that particular system (for ex., atmospheric pressure measurement will not be available if it is not measured by the data logger). If you try to read a register that is not present, the instrument returns the fixed value 32767.

The following conventions have been used in the tables:

- Type: **b** = bit, **B** = 8 bits (Byte), **W** = 16 bits without sign (Word), **SW** = 16 bits with sign
- **(x10)** = decimal value expressed as an integer (e.g., if the content of the register is 184, the value is to be intended as 18,4).
- **(x100)** = centesimal value expressed as an integer (e.g., if the content of the register is 500, the value is to be intended as 5,00).

The commands for requesting units of measurement return an index according to the correspondence indicated in the table below:

TAB. 12.1: indexes of the units of measurement

Index	Unit of meas.	Index	Unit of meas.	Index	Unit of meas.	Index	Unit of meas.	Index	Unit of meas.
0	°C	14	inchH ₂ O	28	V	42	inch/h	56	μmol/(m ² s)
1	°F	15	kgf/cm ²	29	mV	43	counts/h	57	mm/day
2	%UR	16	PSI	30	mA	44	mW/m ²	58	kV
3	g/m ³	17	m/s	31	ppm	45	m	59	A
4	g/kg	18	km/h	32	Hz	46	s	60	kA
5	mbar	19	ft/s	33	%	47	μW/lumen	61	cm/s
6	bar	20	mph	34	degrees	48	dB	62	klux
7	Pa	21	knot	35	lux	49	dBA	63	m ³
8	hPa	22	W/m ²	36	m ² /s	50	kWh	64	g/(m ² s)
9	kPa	23	μW/cm ²	37	g (*)	51	l/s	65	μg/(m ³)
10	atm	24	Wh/m ²	38	mm	52	l/min	66	μm
11	mmHg	25	kWh/m ²	39	inch	53	gallon/min		
12	mmH ₂ O	26	J/m ²	40	counts	54	m ³ /min		
13	inchHg	27	μJ/cm ²	41	mm/h	55	m ³ /h	255	Undefined

(*) Gravity acceleration

TAB. 12.2: Coils – Read/Write parameters

Address	Type	Coil description
0	b	Waiting time after Modbus transmission: 0= immediate reception, 1=waiting time for 3.5 characters
1	b	Logging status: 0=active, 1=inactive
2	b	Logging mode: 0=non cyclic, 1=cyclic
3	b	Set 1 to delete the device logging memory. Bit zeroing is automatic.
4	b	Buzzer and relays activation in case of measurement alarm: 0=no, 1=yes
9	b	Protection of configuration with password: 0=no, 1=yes. Changing the parameter requires the Administrator password (see Holding Register 10036).
10	b	Height from the ground of the cup anemometer: 0=human height, 1=10 m
11	b	Average wind speed and direction calculation method ⁽¹⁾ for the cup anemometer ⁽³⁾ : 0=scalar, 1=vector
12	b	Wind direction measuring range ⁽²⁾ for the cup anemometer ⁽³⁾ : 0=0...359.9°, 1=0...539.9°
13	b	Set 1 to reset all the "counter" type measurements (e.g. the rainfall quantity measurement). Bit zeroing is automatic.

Address	Type	Coil description
22	b	Wind speed when the measurement is below the minimum threshold of the sensors: 0=0 m/s, 1= threshold value in m/s

(1) **Scalar average:** the average intensity is calculated as average of intensities. For the calculation of the average direction, also called "prevailing direction", the velocity versor (unit vector having the same direction of the velocity vector) is considered for each measurement, and the versor coordinates along the measurement axes are calculated, then the average of the coordinates along each axis is calculated. The two average coordinates determine the average versor and therefore the average direction.

Vector average: for each measurement, the coordinates of the velocity vector along the measurement axes are calculated and then the average of the coordinates along each axis is calculated. The average intensity and the average direction are those determined by the two average coordinates.

(2) The wind direction measuring range, normally 0...359.9°, can be extended to 0...539.9° in order to avoid the oscillation of the measurement between initial and full scale if the direction continues to slightly fluctuate around 0° (the change 0→359.9° takes place, but not the change 359.9→0°). If 539.9° value is exceeded in extended mode, the output goes to 180°.

(3) If using HD51.3D... and HD52.3D... series ultrasonic anemometers, the type of average and the wind direction measuring range can be set directly in the anemometer.

TAB. 12.3: Input Registers – Read-only parameters

Address	Type	Input Register description
Measured values and status of measurement alarms		
0	SW	TEMPERATURE with NTC10K sensor in the set measurement unit (x10).
1	B	Alarm for temperature with NTC10K sensor of channel 1: 0=OFF, 1= lower threshold alarm, 2= higher threshold alarm
2	SW	RELATIVE HUMIDITY in % (x10).
3	B	Relative humidity alarm: 0=OFF, 1=lower threshold alarm, 2=higher threshold alarm.
4	SW	DEW POINT in the set measurement unit (x10).
5	B	Dew Point alarm: 0=OFF, 1=lower threshold alarm, 2=higher threshold alarm.
6	SW	PARTIAL VAPOR PRESSURE in hPa (x100).
7	B	Partial vapor pressure alarm: 0=OFF, 1=lower threshold alarm, 2=higher threshold alarm.
8	SW	MIXING RATIO in g/Kg (x10).
9	B	Mixing ratio alarm: 0=OFF, 1=lower threshold alarm, 2=higher threshold alarm.
10	SW	ABSOLUTE HUMIDITY in g/m ³ (x10).
11	B	Absolute humidity alarm: 0=OFF, 1=lower threshold alarm, 2=higher threshold alarm.
12	SW	WET BULB TEMPERATURE in the set measurement unit (x10).
13	B	Wet bulb temperature alarm: 0=OFF, 1=lower threshold alarm, 2=higher threshold alarm.
18	SW	SOLAR RADIATION in W/m ² .
19	B	Alarm for solar radiation: 0=OFF, 1=lower threshold alarm, 2=higher threshold alarm.
20	SW	ILLUMINANCE in lux (low range).
21	B	Illuminance (low range) alarm: 0=OFF, 1=lower threshold alarm, 2=higher threshold alarm.
24	SW	ATMOSPHERIC PRESSURE in the set measurement unit (the multiplier depends on the set unit).
25	B	Atmospheric pressure alarm: 0=OFF, 1=lower threshold alarm, 2=higher threshold alarm.
30	SW	DAILY SOLAR RADIATION in Wh/m ² .
31	B	Alarm for daily solar radiation: 0=OFF, 1=lower threshold alarm, 2=higher threshold alarm.
32	SW	CO₂ in ppm.

Address	Type	Input Register description
33	B	CO ₂ alarm: 0=OFF, 1=lower threshold alarm, 2=higher threshold alarm.
34	SW	SOIL VOLUMETRIC WATER CONTENT (VWC) in % (x10).
35	B	Soil volumetric water content alarm: 0=OFF, 1=lower threshold alarm, 2=higher threshold alarm.
36	SW	VWC PROBE OUTPUT in mV (x10).
37	B	VWC probe output alarm: 0=OFF, 1=lower threshold alarm, 2=higher threshold alarm.
52	SW	WIND SPEED (cup anemometer) in the set measurement unit (the multiplier depends on the set unit).
53	B	Wind speed (cup anemometer) alarm: 0=OFF, 1=lower threshold alarm, 2=higher threshold alarm.
54	SW	WIND DIRECTION (wind vane) in degrees.
55	B	Wind direction (wind vane) alarm: 0=OFF, 1=lower threshold alarm, 2=higher threshold alarm.
58	SW	WIND CHILL in the set measurement unit (x10).
59	B	Wind chill alarm: 0=OFF, 1=lower threshold alarm, 2=higher threshold alarm.
64	SW	TEMPERATURE with Pt100 sensor (HD51.3D.../HD52.3D... anemometer) in the set measurement unit (x10).
65	B	Alarm for temperature with Pt100 sensor (HD51.3D.../HD52.3D... anemometer): 0=OFF, 1=lower threshold alarm, 2=higher threshold alarm.
66	SW	PYRANOMETER OUTPUT in mV (x100).
67	B	Pyranometer output alarm: 0=OFF, 1=lower threshold alarm, 2=higher threshold alarm.
68	SW	UVA IRRADIANCE in mW/m ² .
69	B	UVA irradiance alarm: 0=OFF, 1=lower threshold alarm, 2=higher threshold alarm.
72	SW	WET BULB TEMPERATURE measured by the natural ventilation wet bulb probe, in the set measurement unit (x10).
73	B	Wet bulb temperature alarm: 0=OFF, 1=lower threshold alarm, 2=higher threshold alarm.
74	SW	GLOBE THERMOMETER TEMPERATURE in the set measurement unit (x10).
75	B	Globe thermometer temperature alarm: 0=OFF, 1=lower threshold alarm, 2=higher threshold alarm.
76	SW	INDOOR WBGT INDEX in the set measurement unit (x10).
77	B	Indoor WBGT index alarm: 0=OFF, 1=lower threshold alarm, 2=higher threshold alarm.
78	SW	OUTDOOR WBGT INDEX in the set measurement unit (x10).
79	B	Outdoor WBGT index alarm: 0=OFF, 1=lower threshold alarm, 2=higher threshold alarm.
80	SW	ILLUMINANCE in lux (high range).
81	B	Illuminance (high range) alarm: 0=OFF, 1=lower threshold alarm, 2=higher threshold alarm.
82	SW	WIND GUST in m/s for the cup anemometer.
83	B	Wind gust alarm for the cup anemometer: 0=OFF, 1=lower threshold alarm, 2=higher threshold alarm.
86	SW	RAIN RATE in counts/h.
87	B	Rain rate alarm: 0=OFF, 1=lower threshold alarm, 2=higher threshold alarm.
88	SW	DAILY RAIN in counts.
89	B	Daily rain alarm: 0=OFF, 1=lower threshold alarm, 2=higher threshold alarm.
92	SW	WIND SPEED (HD51.3D.../HD52.3D... anemometer) in m/s (x100).
93	B	Wind speed (HD51.3D.../HD52.3D... anemometer) alarm: 0=OFF, 1=lower threshold alarm, 2=higher threshold alarm.

Address	Type	Input Register description
94	SW	WIND DIRECTION (HD51.3D.../HD52.3D... anemometer) in degrees (x10).
95	B	Wind direction (HD51.3D.../HD52.3D... anemometer) alarm: 0=OFF, 1=lower threshold alarm, 2=higher threshold alarm.
102	SW	STATE OF THE CONTACT INPUT.
103	B	Contact input alarm: 0=OFF, 1=lower threshold alarm, 2=higher threshold alarm.
104	SW	FLOW in l/s.
105	B	Flow (l/s) alarm: 0=OFF, 1=lower threshold alarm, 2=higher threshold alarm.
106	SW	FLOW in l/min.
107	B	Flow (l/min) alarm: 0=OFF, 1=lower threshold alarm, 2=higher threshold alarm.
108	SW	FLOW in m ³ /min.
109	B	Flow (m ³ /min) alarm: 0=OFF, 1=lower threshold alarm, 2=higher threshold alarm.
110	SW	SOIL VOLUMETRIC WATER CONTENT (VWC) in % (x10) – channel 2 .
111	B	Soil volumetric water content alarm – channel 2: 0=OFF, 1=lower threshold alarm, 2=higher threshold alarm.
112	SW	VWC PROBE OUTPUT in mV (x10) – channel 2 .
113	B	VWC probe output alarm – channel 2: 0=OFF, 1=lower threshold alarm, 2=higher threshold alarm.
114	SW	SOIL VOLUMETRIC WATER CONTENT (VWC) in % (x10) – channel 3 .
115	B	Soil volumetric water content alarm – channel 3: 0=OFF, 1=lower threshold alarm, 2=higher threshold alarm.
116	SW	VWC PROBE OUTPUT in mV (x10) – channel 3 .
117	B	VWC probe output alarm – channel 3: 0=OFF, 1=lower threshold alarm, 2=higher threshold alarm.
118	SW	AIR SPEED (HD404...SR transmitter) in m/s (x100).
119	B	Air speed (HD404...SR transmitter) alarm: 0=OFF, 1=lower threshold alarm, 2=higher threshold alarm.
120	SW	PAR (Photosynthetically Active Radiation) in $\mu\text{mol}/(\text{m}^2\text{s})$.
121	B	PAR alarm: 0=OFF, 1=lower threshold alarm, 2=higher threshold alarm.
122	SW	RAINFALL QUANTITY IN THE LAST HOUR in counts.
123	B	Alarm for rainfall quantity in the last hour: 0=OFF, 1=lower threshold alarm, 2=higher threshold alarm.
128	SW	POWER SUPPLY VOLTAGE in V (x100).
129	B	Power supply voltage alarm: 0=OFF, 1=lower threshold alarm, 2=higher threshold alarm.
130	SW	RAINFALL QUANTITY in counts.
131	B	Rainfall quantity alarm: 0=OFF, 1=lower threshold alarm, 2=higher threshold alarm.
132	SW	SUN PRESENCE (sunshine duration sensor): 0= sun absent, 1=sun present.
133	B	Sun presence alarm: 0=OFF, 1=lower threshold alarm, 2=higher threshold alarm.
134	SW	SUNSHINE DURATION (sunshine duration sensor) in the last minute in seconds.
135	B	Alarm for sunshine duration in the last minute: 0=OFF, 1=lower threshold alarm, 2=higher threshold alarm.
136	SW	SUNSHINE DURATION (sunshine duration sensor) in the last 10 minutes in counts (number of tens of seconds).
137	B	Alarm for sunshine duration in the last 10 minutes: 0=OFF, 1=lower threshold alarm, 2=higher threshold alarm.
142	SW	HOURLY EVAPOTRANSPIRATION in mm/h (x100).
143	B	Hourly evapotranspiration alarm: 0=OFF, 1=lower threshold alarm, 2=higher threshold alarm.
144	SW	DAILY EVAPOTRANSPIRATION in mm/h (x100).

Address	Type	Input Register description
145	B	Daily evapotranspiration alarm: 0=OFF, 1=lower threshold alarm, 2=higher threshold alarm.
146	SW	NET RADIATION in W/m ² .
147	B	Net radiation alarm: 0=OFF, 1=lower threshold alarm, 2=higher threshold alarm.
148	SW	RELATIVE PRESSURE in hPa.
149	B	Relative pressure alarm: 0=OFF, 1=lower threshold alarm, 2=higher threshold alarm.
150	SW	FLUID LEVEL in m (x100).
151	B	Fluid level alarm: 0=OFF, 1=lower threshold alarm, 2=higher threshold alarm.
152	SW	LOWER LEAF WETNESS in % (x10).
153	B	Lower leaf wetness alarm: 0=OFF, 1=lower threshold alarm, 2=higher threshold alarm.
154	SW	UPPER LEAF WETNESS in % (x10).
155	B	Upper leaf wetness alarm: 0=OFF, 1=lower threshold alarm, 2=higher threshold alarm.
156	SW	PAR (Photosynthetically Active Radiation) in $\mu\text{mol}/(\text{m}^2\text{s})$ (x10).
157	B	PAR (Photosynthetically Active Radiation, with decimal resolution) alarm: 0=OFF, 1=lower threshold alarm, 2=higher threshold alarm.
158	SW	WIND GUST SPEED (HD51.3D.../HD52.3D... anemometer) in m/s (x100).
159	B	Wind gust speed alarm: 0=OFF, 1=lower threshold alarm, 2=higher threshold alarm.
160	SW	WIND GUST DIRECTION (HD51.3D.../HD52.3D... anemometer) in degrees (x10).
161	B	Wind gust direction alarm: 0=OFF, 1=lower threshold alarm, 2=higher threshold alarm.
162	SW	UVA IRRADIANCE in W/m ² (x100).
163	B	UVA irradiance (with centesimal resolution) alarm: 0=OFF, 1=lower threshold alarm, 2=higher threshold alarm.
168	SW	RELATIVE HUMIDITY in % (x100).
169	B	Relative humidity (with centesimal resolution) alarm: 0=OFF, 1=lower threshold alarm, 2=higher threshold alarm.
170	SW	MAXIMUM RAIN RATE in mm/h (x10).
171	B	Maximum rain rate alarm: 0=OFF, 1=lower threshold alarm, 2=higher threshold alarm.
172	SW	ALBEDO in % (x10).
173	B	Albedo alarm: 0=OFF, 1=lower threshold alarm, 2=higher threshold alarm.
Measured values and status of measurement alarms for configurable inputs		
1000 + 200x(N-1)	SW	TEMPERATURE with 2-wire Pt100 sensor of channel N in the set measurement unit (x10).
1001 + 200x(N-1)	B	Alarm for temperature with 2-wire Pt100 sensor of channel N : 0=OFF, 1=lower threshold alarm, 2=higher threshold alarm.
1002 + 200x(N-1)	SW	TEMPERATURE with 3-wire Pt100 sensor of channel N in the set measurement unit (x10).
1003 + 200x(N-1)	B	Alarm for temperature with 3-wire Pt100 sensor of channel N : 0=OFF, 1=lower threshold alarm, 2=higher threshold alarm.
1004 + 200x(N-1)	SW	TEMPERATURE with 4-wire Pt100 sensor of channel N in the set measurement unit (x10).
1005 + 200x(N-1)	B	Alarm for temperature with 4-wire Pt100 sensor of channel N : 0=OFF, 1=lower threshold alarm, 2=higher threshold alarm.
1006 + 200x(N-1)	SW	TEMPERATURE with 2-wire Pt1000 sensor of channel N in the set measurement unit (x10).
1007 + 200x(N-1)	B	Alarm for temperature with 2-wire Pt1000 sensor of channel N : 0=OFF, 1=lower threshold alarm, 2=higher threshold alarm.

Address	Type	Input Register description
1008 + 200x(N-1)	SW	TEMPERATURE with 3-wire Pt1000 sensor of channel N in the set measurement unit (x10).
1009 + 200x(N-1)	B	Alarm for temperature with 3-wire Pt1000 sensor of channel N : 0=OFF, 1=lower threshold alarm, 2=higher threshold alarm.
1010 + 200x(N-1)	SW	TEMPERATURE with 4-wire Pt1000 sensor of channel N in the set measurement unit (x10).
1011 + 200x(N-1)	B	Alarm for temperature with 4-wire Pt1000 sensor of channel N : 0=OFF, 1=lower threshold alarm, 2=higher threshold alarm.
1012 + 200x(N-1)	SW	TEMPERATURE with TC_K sensor of channel N in the set measurement unit (x10).
1013 + 200x(N-1)	B	Alarm for temperature with TC_K sensor of channel N : 0=OFF, 1=lower threshold alarm, 2=higher threshold alarm.
1014 + 200x(N-1)	SW	TEMPERATURE with TC_J sensor of channel N in the set measurement unit (x10).
1015 + 200x(N-1)	B	Alarm for temperature with TC_J sensor of channel N : 0=OFF, 1=lower threshold alarm, 2=higher threshold alarm.
1016 + 200x(N-1)	SW	TEMPERATURE WITH TC_T sensor of channel N in the set measurement unit (x10).
1017 + 200x(N-1)	B	Alarm for temperature with TC_T sensor of channel N : 0=OFF, 1=lower threshold alarm, 2=higher threshold alarm.
1018 + 200x(N-1)	SW	TEMPERATURE with TC_N sensor of channel N in the set measurement unit (x10).
1019 + 200x(N-1)	B	Alarm for temperature with TC_N sensor of channel N : 0=OFF, 1=lower threshold alarm, 2=higher threshold alarm.
1026 + 200x(N-1)	SW	TEMPERATURE with TC_E sensor of channel N in the set measurement unit (x10).
1027 + 200x(N-1)	B	Alarm for temperature with TC_E sensor of channel N : 0=OFF, 1=lower threshold alarm, 2=higher threshold alarm.
1028 + 200x(N-1)	SW	Input value in mV of channel N (x10). Only if channel N is configured as 0...1 V input.
1029 + 200x(N-1)	B	Alarm for channel N if the channel is configured as 0...1 V input: 0=OFF, 1=lower threshold alarm, 2=higher threshold alarm.
1030 + 200x(N-1)	SW	Input value in mV of channel N (x100). Only if channel N is configured as 0...50 mV input.
1031 + 200x(N-1)	B	Alarm for channel N if the channel is configured as 0...50 mV input: 0=OFF, 1=lower threshold alarm, 2=higher threshold alarm.
1032 + 200x(N-1)	SW	Input value in mA of channel N (x100). Only if channel N is configured as 4...20 mA input.
1033 + 200x(N-1)	B	Alarm for channel N if the channel is configured as 4...20 mA input: 0=OFF, 1=lower threshold alarm, 2=higher threshold alarm.
1034 + 200x(N-1)	SW	Position of potentiometer in % of channel N . Only if channel N is configured as potentiometric input.
1035 + 200x(N-1)	B	Alarm for channel N if the channel is configured as potentiometric input: 0=OFF, 1=lower threshold alarm, 2=higher threshold alarm.
1036 + 200x(N-1)	SW	Value of quantity associated to channel N if the channel is configured as 0...1 V input.
1037 + 200x(N-1)	B	Alarm for quantity associated to channel N if the channel is configured as 0...1 V input: 0=OFF, 1=lower threshold alarm, 2=higher threshold alarm.
1038 + 200x(N-1)	SW	Value of quantity associated to channel N if the channel is configured as 0...50 mV input.
1039 + 200x(N-1)	B	Alarm for quantity associated to channel N if the channel is configured as 0...50 mV input: 0=OFF, 1=lower threshold alarm, 2=higher threshold alarm.
1040 + 200x(N-1)	SW	Value of quantity associated to channel N if the channel is configured as 4...20 mA input.
1041 + 200x(N-1)	B	Alarm for quantity associated to channel N if the channel is configured as 4...20 mA input: 0=OFF, 1=lower threshold alarm, 2=higher threshold alarm.

Address	Type	Input Register description
1042 + 200x(N-1)	SW	Value of quantity associated to channel N if the channel is configured as potentiometric input.
1043 + 200x(N-1)	B	Alarm for quantity associated to channel N if the channel is configured as potentiometric input: 0=OFF, 1=lower threshold alarm, 2=higher threshold alarm.
1044 + 200x(N-1)	SW	Input value in mV of channel N . Only if channel N is configured as 0...10 V input.
1045 + 200x(N-1)	B	Alarm for channel N if the channel is configured as 0...10 V input: 0=OFF, 1=lower threshold alarm, 2=higher threshold alarm.
1046 + 200x(N-1)	SW	Value of quantity associated to channel N if the channel is configured as 0...10 V input.
1047 + 200x(N-1)	B	Alarm for quantity associated to channel N if the channel is configured as 0...10 V input: 0=OFF, 1=lower threshold alarm, 2=higher threshold alarm.
1048 + 200x(N-1)	SW	Value of the Nth quantity acquired from digital bus.
1049 + 200x(N-1)	B	Alarm for Nth quantity acquired from digital bus: 0=OFF, 1=lower threshold alarm, 2=higher threshold alarm.
1050 + 200x(N-1)	SW	Input value in mV of channel N (x100). Only if channel N is configured as -50...50 mV input.
1051 + 200x(N-1)	B	Alarm for channel N if the channel is configured as -50...50 mV input: 0=OFF, 1=lower threshold alarm, 2=higher threshold alarm.
1052 + 200x(N-1)	SW	Value of quantity associated to channel N if the channel is configured as -50...50 mV input.
1053 + 200x(N-1)	B	Alarm for quantity associated to channel N if the channel is configured as -50...50 mV input: 0=OFF, 1=lower threshold alarm, 2=higher threshold alarm.
1054 + 200x(N-1)	SW	FIR (Far Infrared) RADIATION in W/m² of channel N . Only if channel N is configured as Pyrgeometer input.
1055 + 200x(N-1)	B	Alarm for channel N if the channel is configured as pyrgeometer input: 0=OFF, 1=lower threshold alarm, 2=higher threshold alarm.
Rainfall counters		
4006 & 4007	SW	RAINFALL QUANTITY (HD52.3DT...) in the set measurement unit. Register 4007 contains the most significant bits.
4008	B	Rainfall quantity (HD52.3DT...) alarm: 0=OFF, 1=lower threshold alarm, 2=higher threshold alarm.
4009 & 4010	SW	DAILY RAINFALL QUANTITY in the set measurement unit. Register 4010 contains the most significant bits.
4011	B	Daily rainfall quantity alarm: 0=OFF, 1=lower threshold alarm, 2=higher threshold alarm.
da 4128 a 4130	SW	TOTAL RAINFALL QUANTITY (analog tipping bucket rain gauge) in mm (x1000). Register 4130 contains the most significant bits.
Measurement units and resolution		
5000	W	Unit of measurement for TEMPERATURE with NTC10K sensor: 0=°C, 1=°F.
5004	W	DEW POINT measurement unit: 0=°C, 1=°F.
5012	W	WET BULB TEMPERATURE measurement unit: 0=°C, 1=°F.
5021	SW	ILLUMINANCE resolution: -2=100, -1=10, 0=1
5024	W	ATMOSPHERIC PRESSURE measurement unit: see TAB 12.1
5025	SW	ATMOSPHERIC PRESSURE resolution: ..., -2=100, -1=10, 0=1, 1=0.1, 2=0.01, ...
5052	W	WIND SPEED measurement unit: see TAB 12.1
5053	SW	WIND SPEED resolution: ..., -2=100, -1=10, 0=1, 1=0.1, 2=0.01, ...
5058	W	WIND CHILL measurement unit: 0=°C, 1=°F.
5064	W	Unit of measurement for TEMPERATURE with Pt100 sensor (HD51.3D.../HD52.3D... anemometer): 0=°C, 1=°F.
5072	W	Unit of measurement for WET BULB TEMPERATURE measured by the natural ventilation wet bulb probe: 0=°C, 1=°F.

Address	Type	Input Register description
5074	W	Unit of measurement for GLOBE THERMOMETER TEMPERATURE : 0=°C, 1=°F.
5076	W	Unit of measurement for INDOOR WBGT INDEX : 0=°C, 1=°F.
5078	W	Unit of measurement for OUTDOOR WBGT INDEX : 0=°C, 1=°F.
6000 + 200x(N-1)	W	Unit of measurement for TEMPERATURE with 2-wire Pt100 sensor of channel N : 0=°C, 1=°F.
6002 + 200x(N-1)	W	Unit of measurement for TEMPERATURE with 3-wire Pt100 sensor of channel N : 0=°C, 1=°F.
6004 + 200x(N-1)	W	Unit of measurement for TEMPERATURE with 4-wire Pt100 sensor of channel N : 0=°C, 1=°F.
6006 + 200x(N-1)	W	Unit of measurement for TEMPERATURE with 2-wire Pt1000 sensor of channel N : 0=°C, 1=°F.
6008 + 200x(N-1)	W	Unit of measurement for TEMPERATURE with 3-wire Pt1000 sensor of channel N : 0=°C, 1=°F.
6010 + 200x(N-1)	W	Unit of measurement for TEMPERATURE with 4-wire Pt1000 sensor of channel N : 0=°C, 1=°F.
6012 + 200x(N-1)	W	Unit of measurement for TEMPERATURE with TC_K sensor of channel N : 0=°C, 1=°F.
6014 + 200x(N-1)	W	Unit of measurement for TEMPERATURE with TC_J sensor of channel N : 0=°C, 1=°F.
6016 + 200x(N-1)	W	Unit of measurement for TEMPERATURE with TC_T sensor of channel N : 0=°C, 1=°F.
6018 + 200x(N-1)	W	Unit of measurement for TEMPERATURE with TC_N sensor of channel N : 0=°C, 1=°F.
6026 + 200x(N-1)	W	Unit of measurement for TEMPERATURE with TC_E sensor of channel N : 0=°C, 1=°F.
6036 + 200x(N-1)	W	Measurement unit of the quantity associated to channel N if the channel is configured as 0...1 V input. See TAB 12.1
6037 + 200x(N-1)	SW	Resolution of the quantity associated to channel N if the channel is configured as 0...1 V input: ..., -2=100, -1=10, 0=1, 1=0.1, 2=0.01, ...
6038 + 200x(N-1)	W	Measurement unit of the quantity associated to channel N if the channel is configured as 0...50 mV. See TAB 12.1
6039 + 200x(N-1)	SW	Resolution of the quantity associated to channel N if the channel is configured as 0...50 mV: ..., -2=100, -1=10, 0=1, 1=0.1, 2=0.01, ...
6040 + 200x(N-1)	W	Measurement unit of the quantity associated to channel N if the channel is configured as 4...20 mA input. See TAB 12.1
6041 + 200x(N-1)	SW	Resolution of the quantity associated to channel N if the channel is configured as 4...20 mA input: ..., -2=100, -1=10, 0=1, 1=0.1, 2=0.01, ...
6042 + 200x(N-1)	W	Measurement unit of the quantity associated to channel N if the channel is configured as potentiometric input. See TAB 12.1
6043 + 200x(N-1)	SW	Resolution of the quantity associated to channel N if the channel is configured as potentiometric input: ..., -2=100, -1=10, 0=1, 1=0.1, 2=0.01, ...
6046 + 200x(N-1)	W	Measurement unit of the quantity associated to channel N if the channel is configured as 0...10 V input. See TAB 12.1
6047 + 200x(N-1)	SW	Resolution of the quantity associated to channel N if the channel is configured as 0...10 V input: ..., -2=100, -1=10, 0=1, 1=0.1, 2=0.01, ...
6048 + 200x(N-1)	W	Measurement unit of the Nth quantity acquired from digital bus. See TAB 12.1
6049 + 200x(N-1)	SW	Resolution of the Nth quantity acquired from digital bus: ..., -2=100, -1=10, 0=1, 1=0.1, 2=0.01, ...
6052 + 200x(N-1)	W	Measurement unit of the quantity associated to channel N if the channel is configured as -50...50 mV. See TAB 12.1
6053 + 200x(N-1)	SW	Resolution of the quantity associated to channel N if the channel is configured as -50...50 mV: ..., -2=100, -1=10, 0=1, 1=0.1, 2=0.01, ...
9002	W	Measurement unit of the quantity associated to the channel if the channel is configured as counter. See TAB 12.1
9003	SW	Resolution of the quantity associated to the channel if the channel is configured as counter: ..., -2=100, -1=10, 0=1, 1=0.1, 2=0.01, ...

Address	Type	Input Register description
9004	W	Measurement unit of the RAINFALL QUANTITY (HD52.3DT...). See TAB 12.1
9005	SW	Resolution of the RAINFALL QUANTITY (HD52.3DT...): ..., -2=100, -1=10, 0=1, 1=0.1, 2=0.01, ...
9006	W	Measurement unit of the DAILY RAINFALL QUANTITY . See TAB 12.1
9007	SW	Resolution of the DAILY RAINFALL QUANTITY : ..., -2=100, -1=10, 0=1, 1=0.1, 2=0.01, ...
General information		
10000	W	Year of last measurement.
10001	W	Month of last measurement.
10002	W	Day of last measurement.
10003	W	Hour of last measurement.
10004	W	Minutes of last measurement.
10005	W	Seconds of last measurement.
10008	SW	RF signal level in dBm.
10009	W	Battery level: 0=empty, 1=half full, 2=full, 3=external power supply
10010	W	Time, in seconds, elapsed since the last measurement.
10011	W	RF signal level expressed as 0 to 7 scale.
10013	W	Password level for the current connection: 0=no password, 1=user level, 2= administrator level

TAB. 12.4: Holding Registers – Read/Write parameters

Address	Type	Holding Register description
Measurement alarm thresholds		
0	SW	Lower alarm threshold for TEMPERATURE with NTC10K sensor in the set measurement unit (x10).
1	SW	Higher alarm threshold for temperature with NTC10K sensor in the set measurement unit (x10).
2	SW	RH lower alarm threshold in % (x10).
3	SW	RH higher alarm threshold in % (x10).
4	SW	DEW POINT lower alarm threshold in the set measurement unit (x10).
5	SW	Dew point higher alarm threshold in the set measurement unit (x10).
6	SW	PARTIAL VAPOR PRESSURE lower alarm threshold in hPa (x100).
7	SW	Partial vapor pressure higher alarm threshold in hPa (x100).
8	SW	MIXING RATIO lower alarm threshold in g/Kg (x10).
9	SW	Mixing ratio higher alarm threshold in g/Kg (x10).
10	SW	ABSOLUTE HUMIDITY lower alarm threshold in g/m ³ (x10).
11	SW	Absolute humidity higher alarm threshold in g/m ³ (x10).
12	SW	WET BULB TEMPERATURE lower alarm threshold in the set measurement unit (x10).
13	SW	Wet bulb temperature higher alarm threshold in the set measurement unit (x10).
18	SW	Lower alarm threshold for SOLAR RADIATION in W/m ² .
19	SW	Higher alarm threshold for solar radiation in W/m ² .
20	SW	ILLUMINANCE (low range) lower alarm threshold in lux.
21	SW	Illuminance (low range) higher alarm threshold in lux
24	SW	ATMOSPHERIC PRESSURE lower alarm threshold in the set measurement unit (the multiplier depends on the set unit).
25	SW	Atmospheric pressure higher alarm threshold in the set measurement unit (the multiplier depends on the set unit).
30	SW	Lower alarm threshold for DAILY SOLAR RADIATION in Wh/m ² .
31	SW	Higher alarm threshold for daily solar radiation in Wh/m ² .
32	SW	CO₂ lower alarm threshold in ppm.
33	SW	CO ₂ higher alarm threshold in ppm.

Address	Type	Holding Register description
34	SW	Lower alarm threshold for SOIL VOLUMETRIC WATER CONTENT (VWC) in % (x10).
35	SW	Higher alarm threshold for soil volumetric water content (VWC) in % (x10).
36	SW	Lower alarm threshold for VWC PROBE OUTPUT in mV (x10).
37	SW	Higher alarm threshold for VWC probe output in mV (x10).
52	SW	WIND SPEED (cup anemometer) lower alarm threshold in the set measurement unit (the multiplier depends on the set unit).
53	SW	Wind speed (cup anemometer) higher alarm threshold in the set measurement unit (multiplier depends on the set unit).
54	SW	WIND DIRECTION (wind vane) lower alarm threshold in degrees.
55	SW	Wind direction (wind vane) higher alarm threshold in degrees.
58	SW	Lower alarm threshold for WIND CHILL in the set measurement unit (x10).
59	SW	Higher alarm threshold for wind chill in the set measurement unit (x10).
64	SW	Lower alarm threshold for TEMPERATURE with Pt100 sensor (HD51.3D.../HD52.3D... anemometer) in the set measurement unit (x10).
65	SW	Higher alarm threshold for temperature with Pt100 sensor (HD51.3D.../HD52.3D... anemometer) in the set measurement unit (x10).
66	SW	Lower alarm threshold for PYRANOMETER OUTPUT in mV (x100).
67	SW	Higher alarm threshold for PYRANOMETER OUTPUT in mV (x100).
68	SW	UVA IRRADIANCE lower alarm threshold in mW/m ² .
69	SW	UVA irradiance higher alarm threshold in mW/m ² .
72	SW	Lower alarm threshold for WET BULB TEMPERATURE measured by the natural ventilation wet bulb probe, in the set measurement unit (x10).
73	SW	Higher alarm threshold for wet bulb temperature measured by the natural ventilation wet bulb probe, in the set measurement unit (x10).
74	SW	Lower alarm threshold for GLOBE THERMOMETER TEMPERATURE in the set measurement unit (x10).
75	SW	Higher alarm threshold for globe thermometer temperature in the set measurement unit (x10).
76	SW	INDOOR WBGT INDEX lower alarm threshold in the set measurement unit (x10).
77	SW	Indoor WBGT index higher alarm threshold in the set measurement unit (x10).
78	SW	OUTDOOR WBGT INDEX lower alarm threshold in the set measurement unit (x10).
79	SW	Outdoor WBGT index higher alarm threshold in the set measurement unit (x10).
80	SW	ILLUMINANCE (high range) lower alarm threshold in lux.
81	SW	Illuminance (high range) higher alarm threshold in lux
82	SW	WIND GUST lower alarm threshold in m/s for the cup anemometer.
83	SW	Wind gust higher alarm threshold in m/s for the cup anemometer.
86	SW	RAIN RATE lower alarm threshold in counts/h.
87	SW	Rain rate higher alarm threshold in counts/h.
88	SW	DAILY RAIN lower alarm threshold in counts.
89	SW	Daily rain higher alarm threshold in counts.
92	SW	WIND SPEED (HD51.3D.../HD52.3D... anemometer) lower alarm threshold in m/s (x100).
93	SW	Wind speed (HD51.3D.../HD52.3D... anemometer) higher alarm threshold in m/s (x100).
94	SW	WIND DIRECTION (HD51.3D.../HD52.3D... anemometer) lower alarm threshold in degrees (x10).
95	SW	Wind direction (HD51.3D.../HD52.3D... anemometer) higher alarm threshold in degrees (x10).
104	SW	FLOW lower alarm threshold in l/s.
105	SW	Flow higher alarm threshold in l/s.
106	SW	FLOW lower alarm threshold in l/min.
107	SW	Flow higher alarm threshold in l/min.
108	SW	FLOW lower alarm threshold in m ³ /min.
109	SW	Flow higher alarm threshold in m ³ /min.
110	SW	Lower alarm threshold for SOIL VOLUMETRIC WATER CONTENT (VWC) in % (x10) – channel 2 .

Address	Type	Holding Register description
111	SW	Higher alarm threshold for soil volumetric water content in % (x10) – channel 2.
112	SW	Lower alarm threshold for VWC PROBE OUTPUT in mV (x10) – channel 2.
113	SW	Higher alarm threshold for VWC probe output in mV (x10) – channel 2.
114	SW	Lower alarm threshold for SOIL VOLUMETRIC WATER CONTENT (VWC) in % (x10) – channel 3.
115	SW	Higher alarm threshold for soil volumetric water content in % (x10) – channel 3.
116	SW	Lower alarm threshold for VWC PROBE OUTPUT in mV (x10) – channel 3.
117	SW	Higher alarm threshold for VWC probe output in mV (x10) – channel 3.
118	SW	AIR SPEED (HD404...SR transmitter) lower alarm threshold in m/s (x100).
119	SW	Air speed (HD404...SR transmitter) higher alarm threshold in m/s (x100).
120	SW	PAR (Photosynthetically Active Radiation) lower alarm threshold in $\mu\text{mol}/(\text{m}^2\text{s})$.
121	SW	PAR higher alarm threshold in $\mu\text{mol}/(\text{m}^2\text{s})$.
122	SW	Lower alarm threshold for RAINFALL QUANTITY IN THE LAST HOUR in counts.
123	SW	Higher alarm threshold for rainfall quantity in the last hour in counts.
128	SW	POWER SUPPLY VOLTAGE lower alarm threshold in V (x100).
129	SW	Power supply voltage higher alarm threshold in V (x100).
130	SW	RAINFALL QUANTITY lower alarm threshold in counts.
131	SW	Rainfall quantity higher alarm threshold in counts.
132	SW	SUN PRESENCE (sunshine duration sensor) lower alarm threshold.
133	SW	Sun presence (sunshine duration sensor) higher alarm threshold.
134	SW	Lower alarm threshold for SUNSHINE DURATION (sunshine duration sensor) in the last minute in seconds.
135	SW	Higher alarm threshold for sunshine duration (sunshine duration sensor) in the last minute in seconds.
136	SW	Lower alarm threshold for SUNSHINE DURATION (sunshine duration sensor) in the last 10 minutes in counts (number of tens of seconds).
137	SW	Higher alarm threshold for sunshine duration (sunshine duration sensor) in the last 10 minutes in counts (number of tens of seconds).
142	SW	HOURLY EVAPOTRANSPIRATION lower alarm threshold in mm/h (x100).
143	SW	Hourly evapotranspiration higher alarm threshold in mm/h (x100).
144	SW	DAILY EVAPOTRANSPIRATION lower alarm threshold in mm/h (x100).
145	SW	Daily evapotranspiration higher alarm threshold in mm/h (x100).
146	SW	NET RADIATION lower alarm threshold in W/m^2 .
147	SW	Net radiation higher alarm threshold in W/m^2 .
148	SW	RELATIVE PRESSURE lower alarm threshold in hPa.
149	SW	Relative pressure higher alarm threshold in hPa.
150	SW	FLUID LEVEL lower alarm threshold in m (x100).
151	SW	Fluid level higher alarm threshold in m (x100).
152	SW	LOWER LEAF WETNESS lower alarm threshold in % (x10).
153	SW	Lower leaf wetness higher alarm threshold in % (x10).
154	SW	UPPER LEAF WETNESS lower alarm threshold in % (x10).
155	SW	Upper leaf wetness higher alarm threshold in % (x10).
156	SW	PAR (Photosynthetically Active Radiation) lower alarm threshold in $\mu\text{mol}/(\text{m}^2\text{s})$ (x10).
157	SW	PAR (Photosynthetically Active Radiation) higher alarm threshold in $\mu\text{mol}/(\text{m}^2\text{s})$ (x10).
158	SW	WIND GUST SPEED (HD51.3D.../HD52.3D... anemometer) lower alarm threshold in m/s (x100).
159	SW	Wind gust speed (HD51.3D.../HD52.3D... anemometer) higher alarm threshold in m/s (x100).
160	SW	WIND GUST DIRECTION (HD51.3D.../HD52.3D... anemometer) lower alarm threshold in degrees (x10).
161	SW	Wind gust direction (HD51.3D.../HD52.3D... anemometer) higher alarm threshold in degrees (x10).
162	SW	UVA IRRADIANCE lower alarm threshold in W/m^2 (x100).

Address	Type	Holding Register description
163	SW	UVA irradiance higher alarm threshold in W/m ² (x100).
168	SW	RELATIVE HUMIDITY lower alarm threshold in % (x100).
169	SW	Relative Humidity higher alarm threshold in % (x100).
170	SW	MAXIMUM RAIN RATE lower alarm threshold in mm/h (x10).
171	SW	Maximum rain rate higher alarm threshold in mm/h (x10).
172	SW	ALBEDO lower alarm threshold in % (x10).
173	SW	Albedo higher alarm threshold in % (x10).
Measurement alarm thresholds for configurable inputs		
1000 + 200x(N-1)	SW	Lower alarm threshold for TEMPERATURE with 2-wire Pt100 sensor of channel N in the set measurement unit (x10).
1001 + 200x(N-1)	SW	Higher alarm threshold for temperature with 2-wire Pt100 sensor of channel N in the set measurement unit (x10).
1002 + 200x(N-1)	SW	Lower alarm threshold for TEMPERATURE with 3-wire Pt100 sensor of channel N in the set measurement unit (x10).
1003 + 200x(N-1)	SW	Higher alarm threshold for temperature with 3-wire Pt100 sensor of channel N in the set measurement unit (x10).
1004 + 200x(N-1)	SW	Lower alarm threshold for TEMPERATURE with 4-wire Pt100 sensor of channel N in the set measurement unit (x10).
1005 + 200x(N-1)	SW	Higher alarm threshold for temperature with 4-wire Pt100 sensor of channel N in the set measurement unit (x10).
1006 + 200x(N-1)	SW	Lower alarm threshold for TEMPERATURE with 2-wire Pt1000 sensor of channel N in the set measurement unit (x10).
1007 + 200x(N-1)	SW	Higher alarm threshold for temperature with 2-wire Pt1000 sensor of channel N in the set measurement unit (x10).
1008 + 200x(N-1)	SW	Lower alarm threshold for TEMPERATURE with 3-wire Pt1000 sensor of channel N in the set measurement unit (x10).
1009 + 200x(N-1)	SW	Higher alarm threshold for temperature with 3-wire Pt1000 sensor of channel N in the set measurement unit (x10).
1010 + 200x(N-1)	SW	Lower alarm threshold for TEMPERATURE with 4-wire Pt1000 sensor of channel N in the set measurement unit (x10).
1011 + 200x(N-1)	SW	Higher alarm threshold for temperature with 4-wire Pt1000 sensor of channel N in the set measurement unit (x10).
1012 + 200x(N-1)	SW	Lower alarm threshold for TEMPERATURE with TC_K sensor of channel N in the set measurement unit (x10).
1013 + 200x(N-1)	SW	Higher alarm threshold for temperature with TC_K sensor of channel N in the set measurement unit (x10).
1014 + 200x(N-1)	SW	Lower alarm threshold for TEMPERATURE with TC_J sensor of channel N in the set measurement unit (x10).
1015 + 200x(N-1)	SW	Higher alarm threshold for temperature with TC_J sensor of channel N in the set measurement unit (x10).
1016 + 200x(N-1)	SW	Lower alarm threshold for TEMPERATURE with TC_T sensor of channel N in the set measurement unit (x10).
1017 + 200x(N-1)	SW	Higher alarm threshold for temperature with TC_T sensor of channel N in the set measurement unit (x10).
1018 + 200x(N-1)	SW	Lower alarm threshold for TEMPERATURE with TC_N sensor of channel N in the set measurement unit (x10).
1019 + 200x(N-1)	SW	Higher alarm threshold for temperature with TC_N sensor of channel N in the set measurement unit (x10).
1026 + 200x(N-1)	SW	Lower alarm threshold for TEMPERATURE with TC_E sensor of channel N in the set measurement unit (x10).
1027 + 200x(N-1)	SW	Higher alarm threshold for temperature with TC_E sensor of channel N in the set measurement unit (x10).
1028 + 200x(N-1)	SW	Channel N lower alarm threshold in mV (x10). Only if channel N is configured as 0...1 V input.
1029 + 200x(N-1)	SW	Channel N higher alarm threshold in mV (x10). Only if channel N is configured as 0...1 V input.

Address	Type	Holding Register description
1030 + 200x(N-1)	SW	Channel N lower alarm threshold in mV (x100). Only if channel N is configured as 0...50 mV input.
1031 + 200x(N-1)	SW	Channel N higher alarm threshold in mV (x100). Only if channel N is configured as 0...50 mV input.
1032 + 200x(N-1)	SW	Channel N lower alarm threshold in mA (x100). Only if channel N is configured as 4...20 mA input.
1033 + 200x(N-1)	SW	Channel N higher alarm threshold in mA (x100). Only if channel N is configured as 4...20 mA input.
1034 + 200x(N-1)	SW	Channel N lower alarm threshold in % . Only if channel N is configured as potentiometric input.
1035 + 200x(N-1)	SW	Channel N higher alarm threshold in % . Only if channel N is configured as potentiometric input.
1036 + 200x(N-1)	SW	Lower alarm threshold expressed as value of the quantity associated to channel N when the channel is configured as 0...1 V input.
1037 + 200x(N-1)	SW	Higher alarm threshold expressed as value of the quantity associated to channel N when the channel is configured as 0...1 V input.
1038 + 200x(N-1)	SW	Lower alarm threshold expressed as value of the quantity associated to channel N when the channel is configured as 0...50 mV.
1039 + 200x(N-1)	SW	Higher alarm threshold expressed as value of the quantity associated to channel N when the channel is configured as 0...50 mV.
1040 + 200x(N-1)	SW	Lower alarm threshold expressed as value of the quantity associated to channel N when the channel is configured as 4...20 mA.
1041 + 200x(N-1)	SW	Higher alarm threshold expressed as value of the quantity associated to channel N when the channel is configured as 4...20 mA.
1042 + 200x(N-1)	SW	Lower alarm threshold expressed as value of the quantity associated to channel N when the channel is configured as potentiometric input.
1043 + 200x(N-1)	SW	Higher alarm threshold expressed as value of the quantity associated to channel N when the channel is configured as potentiometric input.
1044 + 200x(N-1)	SW	Channel N lower alarm threshold in mV . Only if channel N is configured as 0...10 V input.
1045 + 200x(N-1)	SW	Channel N higher alarm threshold in mV. Only if channel N is configured as 0...10 V input.
1046 + 200x(N-1)	SW	Lower alarm threshold expressed as value of the quantity associated to channel N when the channel is configured as 0...10 V input.
1047 + 200x(N-1)	SW	Higher alarm threshold expressed as value of the quantity associated to channel N when the channel is configured as 0...10 V input.
1048 + 200x(N-1)	SW	Lower alarm threshold of the Nth quantity acquired from digital bus
1049 + 200x(N-1)	SW	Higher alarm threshold of the Nth quantity acquired from digital bus
1050 + 200x(N-1)	SW	Channel N lower alarm threshold in mV (x100). Only if channel N is configured as - 50...50 mV input.
1051 + 200x(N-1)	SW	Channel N higher alarm threshold in mV (x100). Only if channel N is configured as -50...50 mV input.
1052 + 200x(N-1)	SW	Lower alarm threshold expressed as value of the quantity associated to channel N when the channel is configured as -50...50 mV.
1053 + 200x(N-1)	SW	Higher alarm threshold expressed as value of the quantity associated to channel N when the channel is configured as -50...50 mV.
1054 + 200x(N-1)	SW	Lower alarm threshold for FIR (Far Infrared) RADIATION in W/m² of channel N when the channel is configured as Pyrgometer input.
1055 + 200x(N-1)	SW	Higher alarm threshold for FIR (Far Infrared) radiation in W/m ² of channel N when the channel is configured as Pyrgometer input.
Alarm thresholds for rainfall counters		
4008 & 4009	SW	RAINFALL QUANTITY (HD52.3DT...) lower alarm threshold in the set measurement unit. Register 4009 contains the most significant bits.

Address	Type	Holding Register description
4010 & 4011	SW	Rainfall quantity (HD52.3DT...) higher alarm threshold in the set measurement unit. Register 4009 contains the most significant bits.
4012 & 4013	SW	DAILY RAINFALL QUANTITY lower alarm threshold in the set measurement unit. Register 4013 contains the most significant bits.
4014 & 4015	SW	Daily rainfall quantity higher alarm threshold in the set measurement unit. Register 4015 contains the most significant bits.
General information		
10000 to 10019	B	User code with ASCII codification. Acceptable values are in the set {32,...,126}.
10020	W	Current year
10021	W	Current month
10022	W	Current day
10023	W	Current hour
10024	W	Current minute
10025	W	Current second
10026	W	Measurement interval: 0=1s, 1=2s, 2=5s, 3=10s, 4=15s, 5=30s, 6=1min, 7=2min, 8=5min, 9=10min, 10=15min, 11=30min, 12=1h
10027	W	Logging/RF interval: 0=1s, 1=2s, 2=5s, 3=10s, 4=15s, 5=30s, 6=1min, 7=2min, 8=5min, 9=10min, 10=15min, 11=30min, 12=1h
10032	W	Temperature measurement unit: 0=°C, 1=°F
10033	W	Atmospheric pressure measurement unit: see TAB 12.1.
10034	W	Baud rate RS485: 0=9600, 1=19200, 3=38400, 4=57600, 5=115200 bit/s
10035	W	RS485 communication mode: 0=8N1, 1=8N2, 2=8E1, 3=8E2, 4=8O1, 5=8O2
10036	W	Password to be supplied to enable configuration change commands. The reading provides the fixed value 32768.
10037 to 10046	B	Device group with ASCII codification. Acceptable values are in the set {32,...,126}.
10047	W	Wind speed measurement unit: see TAB 12.1.
10048	W	Rainfall quantity measurement unit: see TAB 12.1.
10051	W	Rain gauge resolution, in thousandths of mm <i>Example:</i> 0200 ⇒ 0.200 mm
10052	W	Setting of the quantities to be displayed in the automatic viewing cycle. Set the i-th bit (starting from LSB) to 1 if you wish to include the i-th quantity in the viewing cycle. <i>Example:</i> if in the model measuring and calculating: 1=Temp., 2=RH, 3=Td, 4=PVP, 5=Mix.Ratio, 6=AH, 7=Tw, the register is set to 0000 0000 0010 0010, only the relative humidity (RH) and the absolute humidity (AH) will be displayed alternatively.
10053	W	Setting of the RF quantities (RSSI, PER%) to be displayed in the automatic viewing cycle. Set the i-th bit (starting from LSB) to 1 if you wish to include the i-th RF quantity in the viewing cycle.
10064	W	Modbus address.
20000 to 20011	B	User code with ASCII codification of measurement #1. Available for models with more measurements of the same type.
20012 to 20023	B	User code with ASCII codification of measurement #2. Available for models with more measurements of the same type.
20024 to 20035	B	User code with ASCII codification of measurement #3. Available for models with more measurements of the same type.
20036 to 20047	B	User code with ASCII codification of measurement #4. Available for models with more measurements of the same type.
20048 to 20059	B	User code with ASCII codification of measurement #5. Available for models with more measurements of the same type.
20060 to 20071	B	User code with ASCII codification of measurement #6. Available for models with more measurements of the same type.

Address	Type	Holding Register description
20072 to 20083	B	User code with ASCII codification of measurement #7. Available for models with more measurements of the same type.
20084 to 20095	B	User code with ASCII codification of measurement #8. Available for models with more measurements of the same type.
20096 to 20107	B	User code with ASCII codification of measurement #9. Available for models with more measurements of the same type.
20108 to 20119	B	User code with ASCII codification of measurement #10. Available for models with more measurements of the same type.
20120 to 20131	B	User code with ASCII codification of measurement #11. Available for models with more measurements of the same type.
20132 to 20143	B	User code with ASCII codification of measurement #12. Available for models with more measurements of the same type.

13 STORAGE OF INSTRUMENTS

Storage conditions of the instruments:

- Temperature: -40...+70 °C.
- Humidity: less than 90 %RH no condensation.
- For storage, avoid places where:
 - There is a high level of humidity;
 - Instruments are exposed to direct sun radiation;
 - Instruments are exposed to a high temperature source;
 - There are strong vibrations;
 - There is vapor, salt and/or corrosive gases.

14 SAFETY INSTRUCTIONS

General instructions for safety

These instruments have been manufactured and tested in compliance with the safety standards EN61010-1:2010 for electronic instruments of measure and left the factory in perfect safety technical conditions.

The regular functioning and operational safety of these instruments can be ensured only if all normal safety measures, as well as the specific measures described in this manual, are followed.

The regular functioning and operational safety of the instruments can only be guaranteed under the climatic conditions specified in the manual.

Do not use the instruments in places where there are:

- Corrosive or flammable gases.
- Direct vibrations or bumps to the instrument.
- High-intensity electromagnetic fields, static electricity.

Obligations of the User

The user of the instruments must ensure compliance with the following standards and guidelines for the treatment of hazardous materials:

- EEC directives on workplace safety
- National low regulations on workplace safety
- Accident prevention regulations

15 ORDERING CODES

HD33[L]MT.... Data logger for weather station with mobile communication module. Stores measurements in the internal memory. Transmits the acquired data via FTP, via e-mail or to an HTTP server (Cloud). **Optional** LCD Display. SDI-12 and Master or Slave RS485 MODBUS-RTU connection. Connection to ETHERNET network with MODBUS TCP/IP protocol through **optional** module. Alarm functions. It includes **HD35AP-S** software downloadable from Delta OHM web site.
The battery, the probes and the USB cable CP23 have to be ordered separately. SIM card not included.

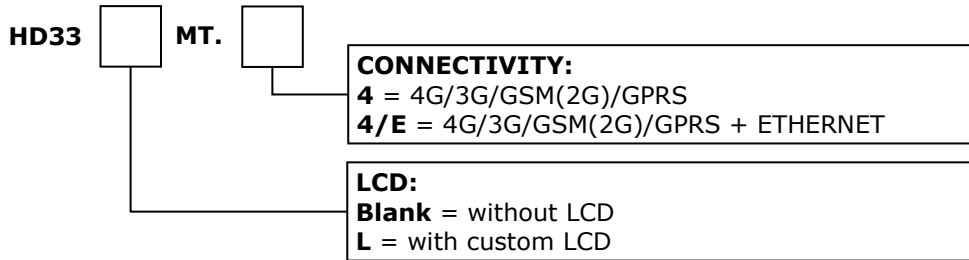

ACCESSORIES

- HD35AP-CFR21** Advanced version of the HD35AP-S software for the management of the data logging system in accordance with the **FDA 21 CFR part 11 recommendations.**
- CP23** Direct USB connection cable with mini-USB male connector on the instrument side and A-type USB male connector on the PC side.
- HD32MT.SWD** 100...240 Vac / 24 Vdc (adjustable) power supply unit with switch. IP 65 housing. Suitable for fastening to a rod. Includes fastening accessories.
- BAT12V-3.4A** 12 V / 3.4 Ah lead-acid rechargeable battery.
- HD2005.20** Tripod kit with adjustable legs for installing environmental sensors (pyranometers, temperature and humidity, etc.). Material: anodized aluminum. Max. height 225 cm. It can be fixed on a flat base with screws or to the ground with pegs. Foldable legs for the transport.
- HD2005.20.1** Tripod kit with adjustable legs for installing environmental sensors (pyranometers, temperature and humidity, etc.). Material: anodized aluminum. Max. height 335 cm. It can be fixed on a flat base with screws or to the ground with pegs. Foldable legs for the transport.

Delta OHM has a wide range of sensors for measuring environmental physical quantities. Please visit www.deltaohm.com or contact Delta OHM directly.

DELTA OHM metrology laboratories LAT N° 124 are accredited ISO/IEC 17025 by ACCREDIA for Temperature, Humidity, Pressure, Photometry / Radiometry, Acoustics and Air Velocity. They can supply calibration certificates for the accredited quantities.

Approvals

HD33[L]MT.4 contains LTE module FCC ID: XMR201903EG25G
IC ID: 10224A-201903EG25G
ANATEL: 02828-19-07968
TELEC certified RF module: [R] 201-190133



R

201-190133

T

AD190040201

**DICHIARAZIONE DI CONFORMITÀ UE
EU DECLARATION OF CONFORMITY**

Delta Ohm S.r.L. a socio unico – Via Marconi 5 – 35030 Caselle di Selvazzano – Padova – ITALY
Tel.: +39 049 8977150 – email: info@deltaohm.com

Documento Nr. / Mese.Anno: **5149 / 02.2020**
Document-No. / Month.Year :

Si dichiara con la presente, in qualità di produttore e sotto la propria responsabilità esclusiva, che i seguenti prodotti sono conformi ai requisiti definiti nelle direttive del Consiglio Europeo:

We declare as manufacturer herewith under our sole responsibility that the following products are in compliance with the requirements defined in the European Council directives:

Codice prodotto: **HD33[L]MT.4 – HD33[L]MT.4/E**
Product identifier :

Descrizione prodotto: **Datalogger con modulo 4G**
Product description : **Data logger with 4G module**

I prodotti sono conformi alle seguenti Direttive Europee:
The products conform to following European Directives:

Direttive / Directives	
2014/53/EU	Direttiva apparecchiature radio / <i>Radio Equipments Directive (RED)</i>
2011/65/EU - 2015/863/EU	RoHS / <i>RoHS</i>

Norme armonizzate applicate o riferimento a specifiche tecniche:
Applied harmonized standards or mentioned technical specifications:

Norme / Standards	
EN 61010-1:2010	Requisiti di sicurezza elettrica / <i>Electrical safety requirements</i>
EN 61326-1:2013	Requisiti EMC / <i>EMC requirements</i>
EN 62479:2010	Esposizione umana a campi elettromagnetici / <i>Human exposure to EMF</i>
ETSI EN 301 511 V12.5.1	Dispositivi GSM / <i>GSM Devices</i>
ETSI EN 301 489-1 V2.1.1	EMC per dispositivi radio / <i>EMC for radio equipments</i>
ETSI EN 301 489-52 V1.1.0	EMC per dispositivi radio mobili di comunicazione cellulare / <i>EMC for Cellular Communication Mobile radio equipments</i>
EN 50581:2012	RoHS / <i>RoHS</i>

Il produttore è responsabile per la dichiarazione rilasciata da:
The manufacturer is responsible for the declaration released by:

Johannes Overhues

Amministratore delegato
Chief Executive Officer

Caselle di Selvazzano, 24/02/2020

Questa dichiarazione certifica l'accordo con la legislazione armonizzata menzionata, non costituisce tuttavia garanzia delle caratteristiche.

This declaration certifies the agreement with the harmonization legislation mentioned, contained however no warranty of characteristics.

GUARANTEE



Member of GHM GROUP

TERMS OF GUARANTEE

All DELTA OHM instruments are subject to accurate testing, and are guaranteed for 24 months from the date of purchase. DELTA OHM will repair or replace free of charge the parts that, within the warranty period, shall be deemed non efficient according to its own judgement. Complete replacement is excluded and no damage claims are accepted. The DELTA OHM guarantee only covers instrument repair. The guarantee is void in case of incidental breakage during transport, negligence, misuse, connection to a different voltage than that required for the appliance by the operator. Finally, a product repaired or tampered by unauthorized third parties is excluded from the guarantee. The instrument shall be returned FREE OF SHIPMENT CHARGES to your dealer. The jurisdiction of Padua applies in any dispute.



The electrical and electronic equipment marked with this symbol cannot be disposed of in public landfills. According to the Directive 2011/65/EU, the european users of electrical and electronic equipment can return it to the dealer or manufacturer upon purchase of a new one. The illegal disposal of electrical and electronic equipment is punished with an administrative fine.

This guarantee must be sent together with the instrument to our service centre.

IMPORTANT: Guarantee is valid only if coupon has been correctly filled in all details.

Instrument Code: **HD33[L]MT.4** **HD33[L]MT.4/E**

Serial Number _____

RENEWALS

Date _____

Date _____

Inspector _____

Inspector _____

Date _____

Date _____

Inspector _____

Inspector _____

Date _____

Date _____

Inspector _____

Inspector _____



The quality level of our instruments is the result of the constant development of the product. This may produce some differences between the information written in this manual and the instrument you have purchased. We cannot completely exclude the possibility of errors in the manual, for which we apologize.

The data, images and descriptions included in this manual cannot be legally asserted. We reserve the right to make changes and corrections with no prior notice.

