

KERN

KERN & Sohn GmbH

Ziegelei 1
D-72336 Balingen
E-Mail: info@kern-sohn.com

Phone: +49-[0]7433- 9933-0
Fax: +49-[0]7433-9933-149
Internet: www.kern-sohn.com

Operating manual Electronic Moisture Analyzer

KERN DLB-A

Type TDLG_A

Version 1.1
2020-12
GB



TDLG_A-BA-e-2011



KERN DLB-A

Version 1.1 2020-12

Operating manual



Electronic Moisture Analyzer

Contents

1	TECHNICAL DATA	4
2	DECLARATION OF CONFORMITY	5
3	APPLIANCE OVERVIEW	6
3.1	Components	6
3.2	Keyboard and display overview	8
4	BASIC INFORMATION (GENERAL)	10
4.1	Proper use	10
4.2	Improper Use	10
4.3	Warranty	10
4.4	Monitoring of Test Resources	10
5	BASIC SAFETY PRECAUTIONS	11
5.1	Pay attention to the instructions in the Operation Manual	11
5.2	Personnel training	11
5.3	Danger Information	11
6	TRANSPORT AND STORAGE	13
6.1	Check upon acceptance	13
6.2	Packaging / return transport	13
7	UNPACKING, SETUP AND COMMISSIONING	14
7.1	Installation Site, Location of Use	14
7.2	Unpacking and checking	15
7.2.1	Scope of delivery / serial accessories:	15
7.3	Placing	16
7.4	Mains connection	17
7.5	Switching on/off	18
7.5.1	Selecting user language	18
7.5.2	Initial Commissioning	18
7.6	Connection of peripheral devices	18
8	ADJUSTMENT	19
8.1	Weight adjustment	19
8.2	Calibrate/adjust the temperature of the heating module	21
8.2.1	Calibration of temperature value	22
8.2.2	Adjust temperature	23
8.3	View / print out adjustment logs	25

9	SETUP MENU	26
9.1	Navigation in the menu	26
9.2	Description of individual functions	27
9.2.1	User language	27
9.2.2	Setting time and date	28
9.2.3	Switch on and off the background illumination	28
9.2.4	Setting the contrast of the display	29
9.2.5	Weighing unit [g / mg]	29
9.2.6	Auto zero	30
9.2.7	Setting the filter	31
9.2.8	Setting the stability	32
10	APPLICATION MENU <MOISTURE ANALYSIS>	33
10.1	Settings of the heating module	34
10.1.1	Setting the heating profile	35
10.1.2	Connect the preheating stage	36
10.1.3	Start mode	37
10.1.4	Start delay	38
10.1.5	Stability test	38
10.2	GLP settings	39
11	MOISTURE ANALYSIS	40
11.1	Define the drying method	40
11.1.1	Setting the drying temperature	40
11.1.2	Adjust the switch-off criterion	41
11.2	Carrying Out Measurement	42
11.3	Sample logs (KERN YKB-01N)	44
11.4	Results display	46
12	RS 232 INTERFACE	47
12.1	Technical data	47
12.2	Adjusting the interface parameters	47
12.2.1	Setting the output interval	48
12.2.2	Select printer type	49
12.2.3	Setting the baud rate	49
12.2.4	Turn on/off GLP function	50
13	GENERAL INFORMATION CONCERNING MOISTURE ANALYSIS	51
13.1	Application	51
13.2	Basics	51
13.3	Drying process	51
13.4	Comparison with a reference procedure	52
13.5	Handling samples	52
14	SERVICING, MAINTENANCE, DISPOSAL	56
14.1	14.1 Cleaning	56
14.2	Servicing, maintenance	56
14.3	Disposal	56
15	INSTANT HELP	57

1 Technical data

Data	DLB 160-3A	DLB 160-3A110V
Item no./ Type	TDLG 160-3-A	TDLG 160-3-A110V
Radiator	Halogen (1 x 400 W)	
Temperature range	35°C - 160°C Choice of steps at 1°C	
Maximum load (Max)	160 g	
Readability (d)	0.001 g (weighing mode)	
	0.01% (moisture content)	
Reproductibility (weighing mode)	0.001 g	
Reproductibility moisture content (depending on application)	Initial weight 2 g	0.15 %
	Initial weight 10 g	0.05 %
Linearity	± 0.003 g	
Stabilization time (typical)	4 sec.	
Smallest sample size	0.05 g	
Recommended adjustment weight, not added (class)	100g (E2)	
Warm-up time	30 min	
Environmental conditions	5°C....+35°C ambient temperature 45% - 70% air humidity non-condensing	
Heating profiles		Standard drying
		Quick drying

Shutoff criterion	<ul style="list-style-type: none"> • Automatic, selectable 1mg/30s – 10 mg/30s • Time-controlled, selectable 1 min – 99 min • Manual switch-off by push-button 	
Sample trays	Ø 95 mm	
Result displays	[%] Moisture content [%] Dry material content [g] Residual weight in grams ATRO	
Interface	RS232	
Dimensions (W x D x H)	Housing 215 x 345 x 235 mm	
Available drying room	Ø 92 mm, 25 mm high	
Net weight	4.7 kg	
Electric Supply	220 – 240 V AC 50/60 Hz	100 - 120 V AC 50/60 Hz
Languages operator guide	German, English, French, Italian, Spanish, Portuguese	

2 Declaration of conformity

The current EC/EU Conformity declaration can be found online in:

www.kern-sohn.com/ce

3 Appliance overview

3.1 Components



Pos.	Designation
------	-------------

- | | |
|----|------------------------|
| 1 | Heater module |
| 2 | Opening handle |
| 3 | Protective glass guard |
| 4 | Temperature sensor |
| 5 | Halogen lamp |
| 6 | Sample tray |
| 7 | Windshield |
| 8 | Removal aid |
| 9 | Display |
| 10 | Keyboard |
| 11 | Levelling screw |

Rear view:



Pos.	Designation
12	Connection of connecting cable „Heating module /
13	Scales
14	Serial Interface RS 232C
15	Mains connection socket
16	Bubble level

3.2 Keyboard and display overview



Status bar:

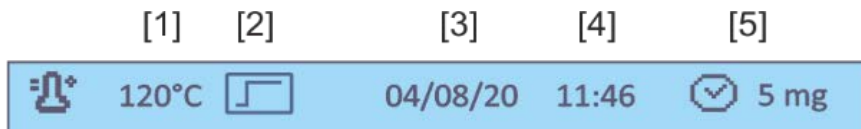

Pos.	Designation
[1]	Set drying temperature
[2]	Active heating profile
[3]	Current date
[4]	Current time
[5]	Active switch off criterion

Toolbar:

The displayed icons in the toolbar depend on the process being executed at this moment.

By pressing the respective functions key (F1 – F6) below the icon, either the function is executed or the settings are taken over.

Toolbar „Start display“

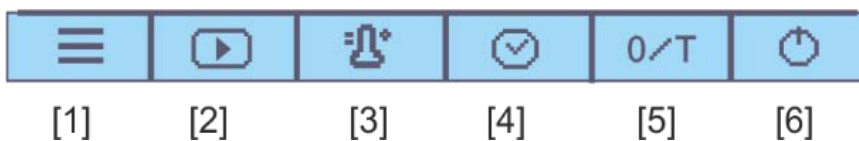

Pos.	Designation
[1]	Call up menu
[2]	Start measurement
[3]	Select drying temperature
[4]	Select switch off criterion
[5]	Set to zero/taring
[6]	Turn on/off

Toolbar during measurement

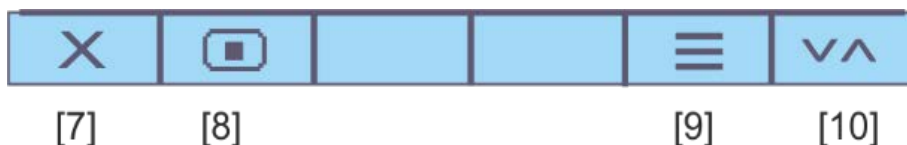

Pos.	Designation
[7]	Interrupt the drying process
[8]	Stopping the drying process
[9]	Display the current drying parameters
[10]	Switch over the unit of the results display (% moisture ➔ %dry content ➔ %Atr ➔ resid.weight [g])

Toolbar „Display of results“

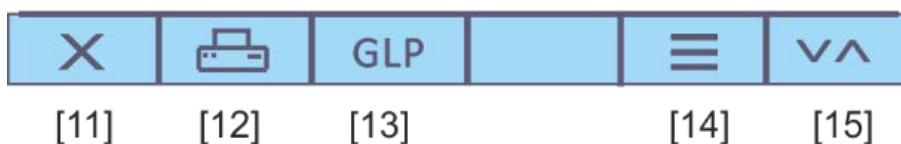

Pos.	Designation
[11]	Exit the drying program / back to start display
[12]	Print out the measurement log
[13]	(de)activate, edit GLP parameters
[14]	Display of start- and residual weight including date and time
[15]	Switch over the unit of the results display, see chap. 11.4 (% moisture ➔ %dry content ➔ %Atr ➔ resid.weight [g])

4 Basic Information (General)

4.1 Proper use

The device purchased by you is designed for a fast and reliable determination of material moisture in liquid and solid materials by applying the method of thermogravimetrics.

4.2 Improper Use

Impacts and overloading exceeding the stated maximum load (max) of the device, minus a possibly existing tare load, must be strictly avoided.

This could cause damage to the integrated balance.

Never operate device in explosive environment. The serial version is not explosion protected.

Changes to the unit's design are not permitted. This may lead to incorrect weighing results, safety-related faults and destruction of the appliance.

The unit may only be operated in accordance with the described default settings. Other areas of use must be released by KERN in writing.

4.3 Warranty

Loss of warranty due to

- Our conditions in the operation manual are ignored
- The appliance is used outside the described uses
- The instrument is modified or opened
- Mechanical damage and damage caused by media, liquids
- Natural wear and tear
- The appliance is improperly set up or incorrectly electrically connected
- The measuring system is overloaded

4.4 Monitoring of Test Resources

In the framework of quality assurance the measuring-related properties of the integrated balance and, if applicable, the testing weight, must be checked regularly. The responsible user must define a suitable interval as well as type and scope of this test. Information is available on KERN's home page (www.kern-sohn.com) with regard to the monitoring of balance test substances and the test weights required for this. In KERN's accredited DKD calibration laboratory test weights and balances may be calibrated (return to the national standard) fast and at moderate cost.

5 Basic Safety Precautions

5.1 Pay attention to the instructions in the Operation Manual



- ⇒ Carefully read this operation manual before setup and commissioning, even if you are already familiar with KERN balances.
- ⇒ All language versions contain a non-binding translation. The original German is binding.

5.2 Personnel training

The instrument may only be operated and maintained by trained personnel.

5.3 Danger Information



WARNING!

- The moisture analyzer is used to analyse the moisture content of materials. This instrument must be used exclusively for this purpose. Any other usage may cause a risk to personnel, damage to the instrument or other material damage.
- The moisture analyzer should be used mainly for the drying of aqueous substances.
- The moisture analyzer may not be used in a hazardous area.
- The moisture analyzer may not be used in an explosive atmosphere.
- The moisture analyzer may only be operated and maintained by trained staff.
- Carefully read this operation manual before setup and commissioning, even if you are already familiar with KERN instruments.
- Never make any modifications or design changes to the equipment whatsoever. Always use original spare parts and accessories.
- Ensure that no liquid gets into the appliance, in the connections on the appliance's backside and in connected peripheral devices (e.g. printer, PC).
If you spill liquid on the device, disconnect it immediately.
Afterwards do not operate the moisture meter and have it checked by a competent KERN stockist before any further use.



CAUTION!
Hazards during and after measuring

- Ensure the correct installation of all components.
- Careful when removing the sample. The sample itself, the sample tray and the heating unit may be very hot.
- Use the sample retainer at all times as it allows safe working and prevents burns.
- Individual parts of the case (e. g. the ventilation grids) may heat up considerably during operation.



CAUTION!
The moisture analyzer operates using heat!

- Maintain sufficient space in the environment of the instrument to prevent heat build-up (distance from the instrument 20cm, upwards 1m).
- The heat extraction of the sample must never be covered, blocked, taped up or altered in any other way.
- Never place combustible materials on, under or next to the instrument, as the environment of the instrument heats up to a high temperature.
- Careful when removing the sample. The sample itself, the sample tray and the heating unit may be very hot.



CAUTION!
Fire or explosion



- Explosive, easily flammable samples and samples that go into a chemical reaction when subjected to heat, may not be analysed with the moisture analyzer.
- If in doubt, conduct a risk analysis.
- Select a drying temperature for samples of this kind that is low enough to prevent ignition or explosion.
- Wear safety goggles.

**WARNING!**

Substances that contain toxic or corrosive ingredients, that produce toxic gases when drying, cause irritation (eyes, skin, respiratory system), induce nausea or result in death

- Sample materials emitting toxic substances must be dried with a special extraction system in place. Create an environment that prevents the inhalation of vapours hazardous to health.

**WARNING!**

Substances which cause corrosive gases when heated (ex. acids).

- In this case work with a smaller sample quantity, because the evaporated gases may condense on cooler body parts and cause corrosion there.

6 Transport and storage

6.1 Check upon acceptance

When receiving the appliance, please check packaging immediately, and the appliance itself when unpacking for possible visible damage.

6.2 Packaging / return transport



- ⇒ Keep all parts of the original packaging for a possibly required return.
- ⇒ Only use original packaging for returning.
- ⇒ Prior to dispatch disconnect all cables and remove loose/mobile parts.
- ⇒ Secure all parts against shifting and damage.

7 Unpacking, Setup and Commissioning

7.1 Installation Site, Location of Use

The instrument is designed to achieve reliable weighing results under normal conditions of use.

You will work accurately and fast, if you select the right location for your moisture analyzer.

On the installation site observe the following:



- Remove explosion prone and easily flammable material in the immediate vicinity.
Emerging vapours, sample tray and all parts of the sample chamber are hot!
- Protect the instrument against direct draughts due to open windows and doors.
- Avoid extreme heat and temperature fluctuations e.g. due to installation next to heat radiators.
- Do not expose the instrument to extreme dampness for longer periods of time. Non-permitted condensation (condensation of air humidity on the instrument) may occur if a cold instrument is taken to a considerably warmer environment. In this case, acclimatize the disconnected instrument for ca. 2 hours at room temperature.
- Avoid direct sunlight.
- The air humidity should be between 45% and 75%, non-condensing.
- Sufficient distance from heat-sensitive materials in area around instrument.
- Protect the instrument against high humidity, vapours and dust,
- Major display deviations (incorrect weighing results) may be experienced, should electromagnetic fields (e.g. due to mobile phones or radio instruments), static electricity accumulations or instable power supply occur. Change location or remove source of interference.
- Avoid static charging of the material to be weighed, weighing container and windshield
- Place the instrument on a firm, level surface.
- Avoid jarring during weighing.

7.2 Unpacking and checking

Take the moisture meter carefully out of its packaging, remove the plastic jacket and install it at the designated work space.

7.2.1 Scope of delivery / serial accessories:



1. Moisture analyzer, see chap. 3.1 Components
2. Power cable
3. Connecting cable „Balance / Heating module“
4. Dish holder
5. Removal aid
6. Windshield
7. Sample trays (10 pieces)

7.3 Placing

The appliance is supplied part-assembled. Immediately after unpacking check if the delivered items are complete. Assemble the separate component parts according to their sequence



1. Insert wind protection ring



2. Insert removal aid



3. Carefully insert the tray holder and twist until it engages.



4. Fit sample tray.

5. Level the device with foot screws until the air bubble of the water balance is in the prescribed circle. Check levelling regularly.

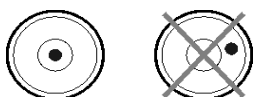

6. Connect the scale and the heating top to the cable as shown on the diagram.

Connect the mains cable to the mains connecting bush of the device, see chap. 7.4

7. Mains connection



7.4 Mains connection



For connection only use the delivered 3-pole mains cable.

The appliance must be connected to a correctly installed standard socket with earth terminal (PE).

Check, whether the voltage acceptance on the device is set correctly. Do not connect the appliance to the power grid unless the information on the appliance (sticker) matches the local mains voltage.

Do not eliminate the protective effect by using an extension lead without earth terminal. For power supplies from power grids without earth terminals call a specialist to establish equivalent protection according to the relevant installation regulations.

- Ensure access to mains plug at all times.
- Before starting, check the mains cable for damage.
- Place the cable in a way that it cannot be damaged or hinders the measuring process.



Important:

Does the rating match the standard local mains current?

- Do not connect if mains voltages are different!
- If matching, the moisture analyzer may be connected.

7.5 Switching on/off

- ⇒ Supply balance with power via the mains power cable. The display unit lights up, the software version and the model name are shortly displayed. From that point onwards the weighing scale will be in standby mode.



- ⇒ To **turn on** the display, press the F6-key. As soon as the weight display appears, the instrument will be ready to weigh.

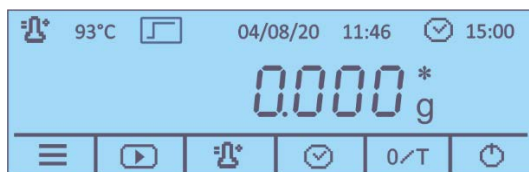

- ⇒ To **switch off** the appliance and to transit into standby-operation, press the F6-key.

7.5.1 Selecting user language

The display is configured to German upon delivery. For setting additional languages see chap. 9.2.1.

7.5.2 Initial Commissioning

In order to receive precise weighing results from electronic balances, the instrument must have reached its operating temperature (see warming-up time chapter 1). The integrated balance must be connected to the power supply during this warming up period.

The accuracy of the integrated balance depends on the local acceleration of gravity. Strictly observe hints in chapter Adjustment.

7.6 Connection of peripheral devices

Before connecting or disconnecting of additional devices (printer, PC) to the data interface, always disconnect the moisture analyzer from the power supply. Only use accessories and peripheral devices by KERN, as they are ideally tuned to the appliance.

8 Adjustment

8.1 Weight adjustment

The weight adjustment of the integrated balance is not necessary for a correct moisture analysis as this measurement can only be made relatively. The instrument measures the weight of the sample before and after the drying process and the moisture content is determined by the relation between wet and dry weight. The instrument however should be adjusted, if this is required by the quality system which you apply.



Procedure:

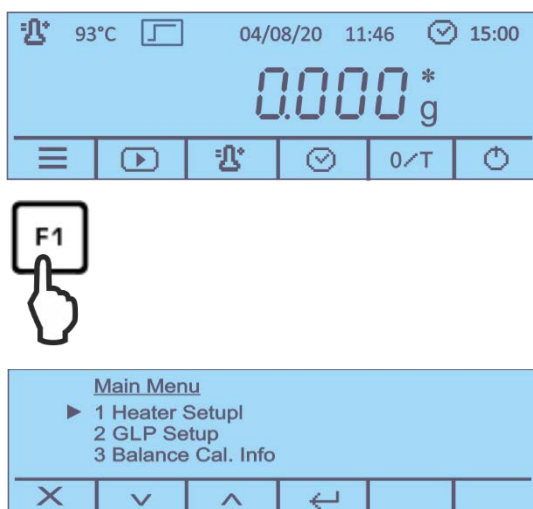

- Observe stable environmental conditions. A warm up time (see chapter 1) is required for stabilization.
- Carry out adjustment with placed sample tray. Ensure that no objects are within the sample tray.
- Carry out adjustment as near as possible to the balance's maximum weight (recommended adjustment weight see chap. 1). Info about test weights can be found on the Internet at: <http://www.kern-sohn.com>.

1. In the start display press the F1-key, the main menu will appear.



- Use the buttons under  to select the menu item **<5-Balance Calibration>** and acknowledge by  .

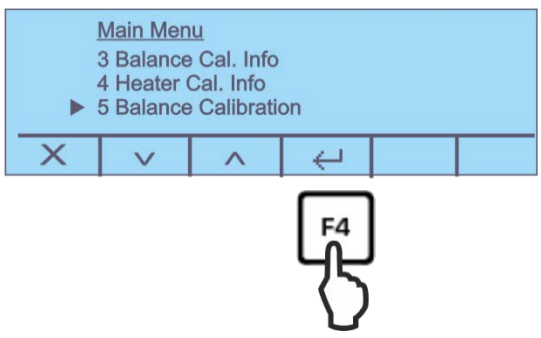

- The weight value of the required adjustment weight will be displayed.

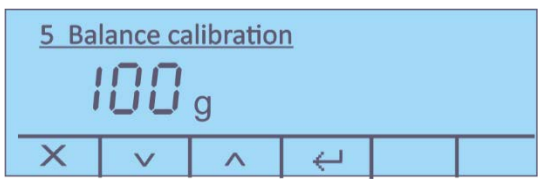

- Acknowledge with .

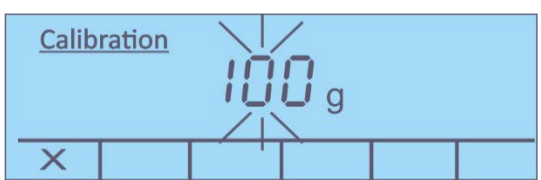
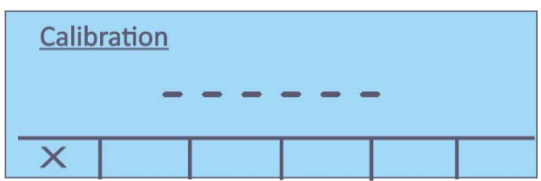

- During** the flashing weight display put the required adjustment weight carefully in the centre of the sample tray.
 The flashing display disappears.
 After successful adjustment the balance automatically returns to weighing mode, „100.000 g“ is displayed. Take away adjustment weight.

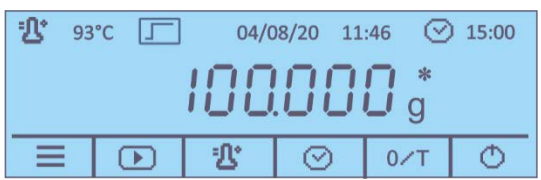

8.2 Calibrate/adjust the temperature of the heating module

We recommend sometimes to check the temperature value of the device using the optional temperature calibrating set DLB-A01N. Before you do this, allow the device to cool down for at least 3 hours after the last heating phase.

Preparation:

- ⇒ Turn on moisture analyzer
- ⇒ Install temperature calibrating set as per illustration

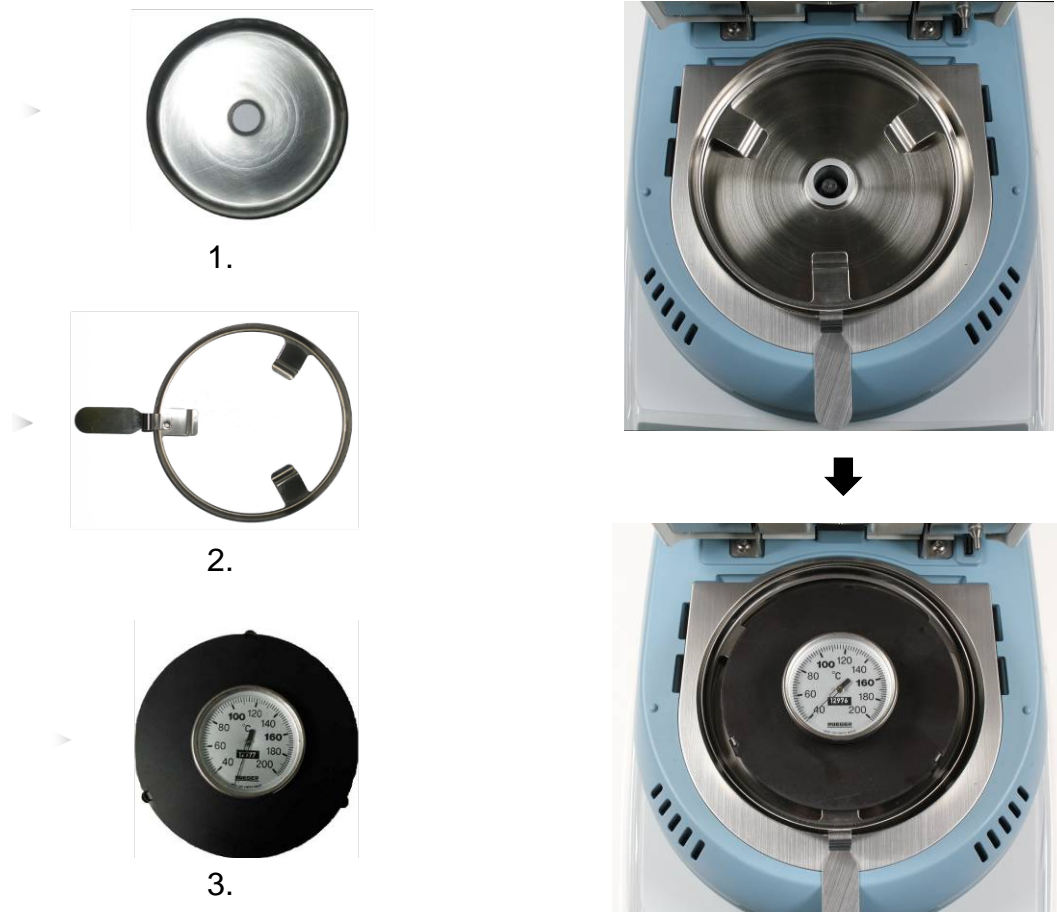



- ⇒ Turn on moisture analyzer.
- ⇒ Close heating cover.

8.2.1 Calibration of temperature value

During temperature calibration only a check is carried out, i.e. no values are changed.

1. In the start display press the F1-key, the main menu will appear.



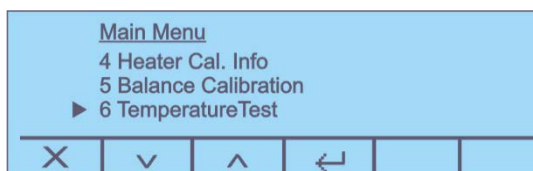

2. Press  to select the menu item **<6 - Temperature Test>** and acknowledge by .



3. Acknowledge by , the current setting is displayed.



4. Press  to acknowledge the following instruction how to use a temperature calibration set
5. Select desired test temperature with  and acknowledge by . The device heats up the set temperature.

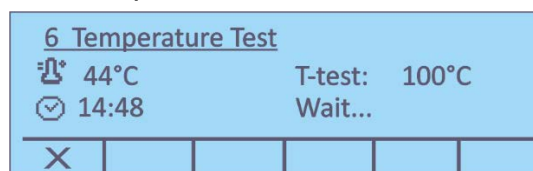



6. After 15 minutes the test is finished, an acoustic signal sounds. Compare the test temperature with the displayed temperature of the DLB-A01N. If the two values do not match, we recommend a temperature adjustment, see chap. 8.2.2
7. Press  to cancel the calibration.

8.2.2 Adjust temperature



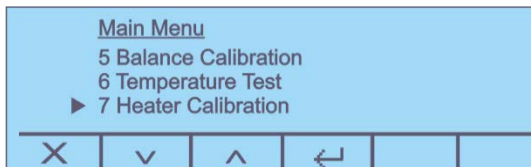

If in temperature calibration the admitted divergence is exceeded or not reached, the temperature of the instrument can be adjusted as described below.

1. Select menu item **<7 – Heater Calibration>** (see chap. 8.2.1, step 1) and confirm by .

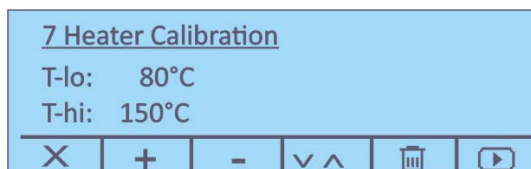

2. Confirm the inquiries **<Are you sure>** and the following instruction how to use a temperature calibration set by .
The current settings of the both temperature points T-lo / T-hi are displayed.



3. Press   to select the desired test temperature and press  to select between **<T-lo>** and **<T-hi>**. Acknowledge with .
4. Press , the first heating phase is started.

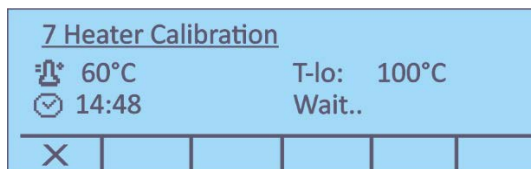

5. Temperature calibration for the first point takes 15 min. Compare the temperature displayed on the DLB-A01N with that of the moisture analyzer.
If the two values do not match, correct with .

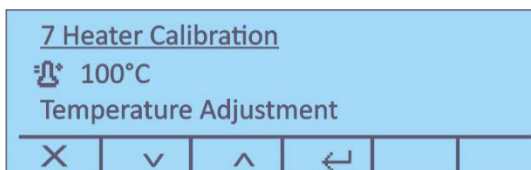

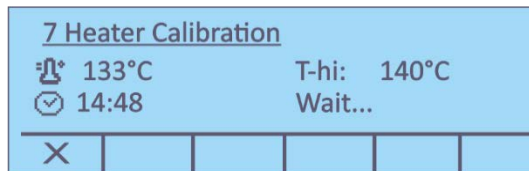

6. Confirm by , the second heating phase is started.

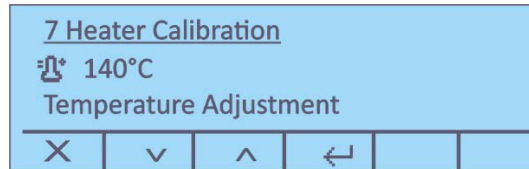

7. Temperature calibration for the second point takes 15 min. Compare the temperature displayed on the DLB-A01N with that of the moisture analyzer.



If the two values do not match, correct with the help of  and confirm by .



8. When an optional printer is connected, an adjustment log can be edited.
9. Press  to return into menu / start display.

8.3 View / print out adjustment logs

- ⇒ In the main menu (see chap. 10) press  to select the menu item **<3 Balance Cal. Info>** or **<4 Heater Cal. Info.>** and acknowledge by .

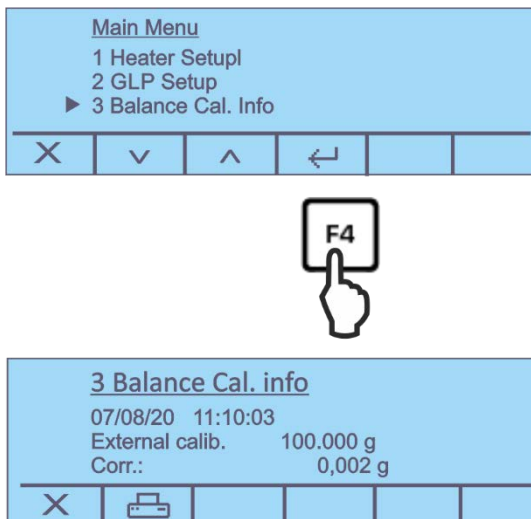

- ⇒ The adjustment protocol will be displayed.
- ⇒ When an optional printer is connected, an adjustment log can be edited by pressing .

Sample log (KERN YKB-01N) External adjustment	Sample log (KERN YKB-01N) Temperature adjustment
<pre> ----- 13/08/20 09:53:12 ----- ID Waage: WIC201234 ----- ID User: MUSTERMANN ----- ID Projekt: KERN ----- Justiermodus: 10/08/20 09:39:47 T-lo: 100° C T-hi: 140° C Unterschrift: ----- </pre>	<pre> ----- 13/08/20 09:53:40 ----- ID Waage: WIC201234 ----- ID User: MUSTERMANN ----- ID Projekt: KERN ----- Justiermodus: 07/08/20 11:10:11 Externe Justier. 100.000 g Korr. : 0.002 g Unterschrift: ----- </pre>

9 Setup menu

In the setup menu, are adjusted all basic settings and parameters, which influence the whole operation of the scale.

The following functions are available:

Serial output	see chap. 12.2
Time and date	see chap. 9.2.2
Language	see chap. 9.2.1
Background lighting	see chap. 9.2.3
Contrast of the display	see chap. 9.2.4
Weighing unit [g / mg]	see chap. 9.2.5
Auto zero	see chap. 9.2.6
Filter	see chap. 9.2.7
Stability	see chap. 9.2.8

9.1 Navigation in the menu

Access to menu In the start display keep pressed the F1-key for 2 seconds, then release. The setup menu is displayed.

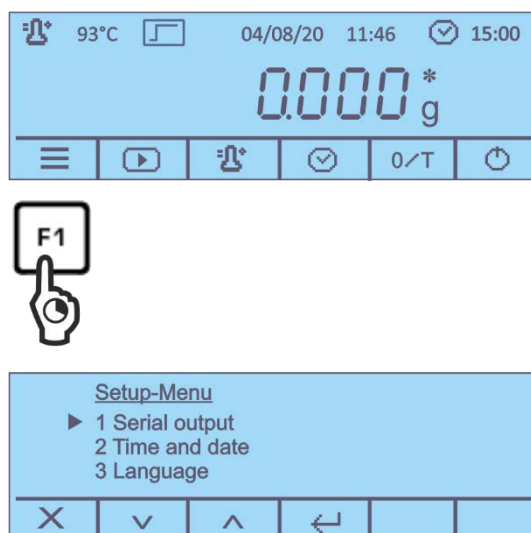

The cursor ► on the left of the text shows the active menu item.

Select menu items It is possible to select the single menu items one by one with the buttons F2 and F3 under the icons .

Change settings

Acknowledge the selected menu item using the F4 button under the icon , the available settings are displayed.

Every time the buttons F2 and F3 under the icons  are pressed, the following setting will be displayed.

Save settings

Take over the selection using the F4 button under the icon .



Weighing balance returns to menu. Either make more settings in the menu or go back to menu mode as follows.

Finish the menu/ back to the start display

Press the F1 button under the icon .

9.2 Description of individual functions

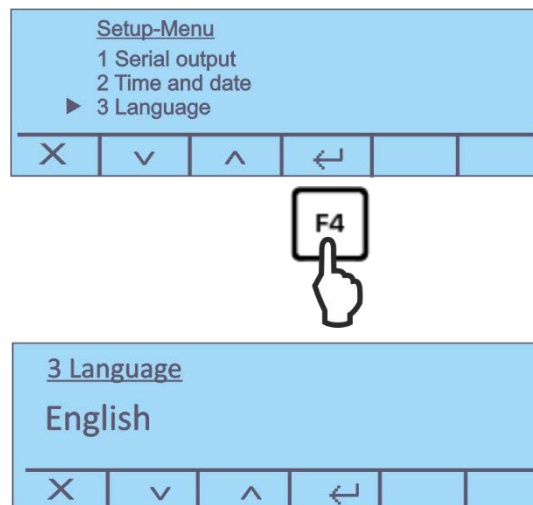

9.2.1 User language

⇒ Press  to select the menu item **<3 Language>** and acknowledge by .







⇒ Acknowledge selection by .

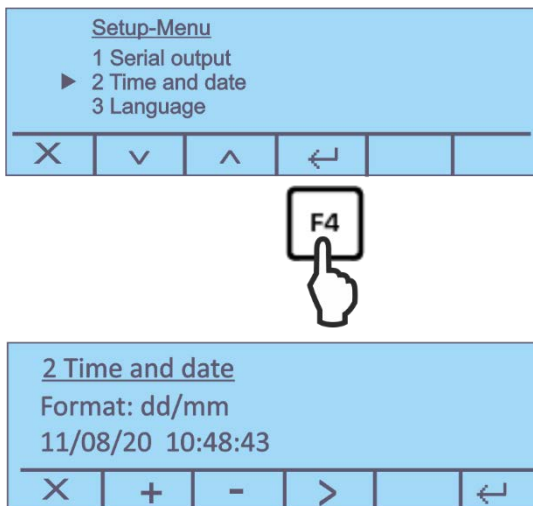

9.2.2 Setting time and date

- ⇒ Press  to select the menu item **<2 Time and Date>** and acknowledge by .



- ⇒ Press  to set the desired format.
- ⇒ Press  to select time / date and adjust by . The active digit is underlined.
- ⇒ Confirm input by .

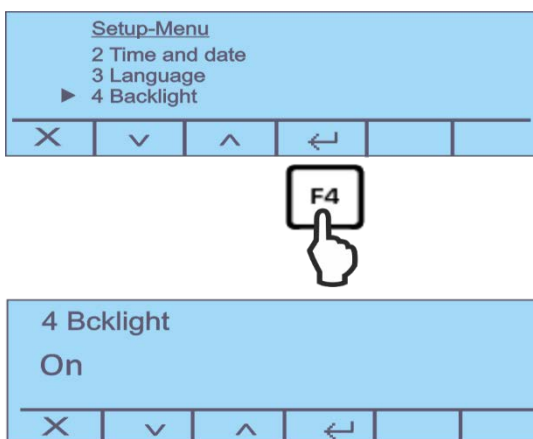

9.2.3 Switch on and off the background illumination

- ⇒ Press  to select the menu item **<4 Backlight>** and acknowledge by .





- ⇒ Acknowledge selection by .

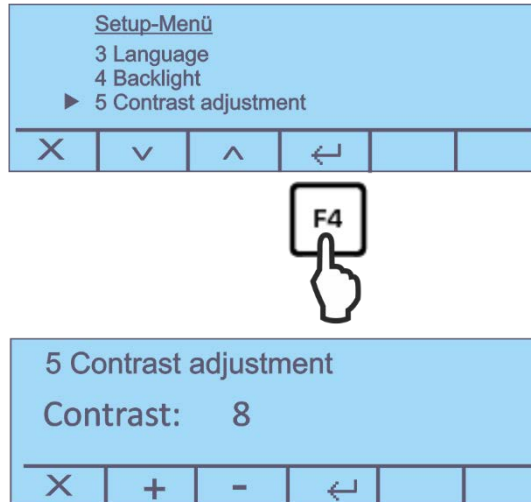

9.2.4 Setting the contrast of the display

- ⇒ Press  to select the menu item **<5 Contrast adjustment>** and acknowledge by .





- ⇒ Press  to increase or to reduce the value.
Adjustment range 0 -15
- ⇒ Acknowledge selection by .

9.2.5 Weighing unit [g / mg]

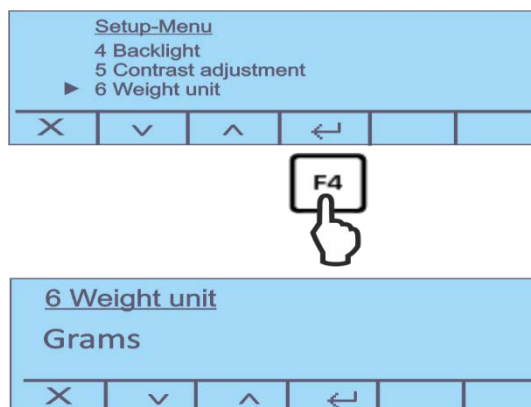
- ⇒ Press  to select the menu item **<6 Weight unit>** and acknowledge by .



- ⇒ Use  to adjust <Gram> or <Milligram>
- ⇒ Acknowledge selection by .



9.2.6 Auto zero

Under this menu item the automatic zero point correction can be switched on or off. In switched-on-state the zero point is automatically corrected at drift or when dirty.

Note:

In the event that small quantities are removed or added to the material to be weighed, incorrect weighing results can be displayed due to the “stability compensation”. (e.g. slow flow of liquids from a container placed on the balance, evaporating processes).

When apportioning involves small variations of weight, it is advisable to switch off this function.

⇒ Press  to select the menu item **<7 Auto zero>** and acknowledge by .



⇒ Press  to select the desired setting.



Options:

- | | |
|---------------|------------------------------------------------------------|
| Auto zero off | Auto Zero switched off |
| Auto zero 1 | Auto Zero range $\pm \frac{1}{2}$ Digit |
| Auto zero 2 | Auto Zero range ± 3 Digits |
| Auto zero 3 | Auto Zero range ± 7 Digits |
| Auto zero 3E | Auto Zero range ± 7 digits in the whole weighing range |

⇒ Acknowledge selection by .

9.2.7 Setting the filter

This menu item allows the balance to be set according to specific ambient conditions and measuring purposes.

⇒ Press  to select the menu item **<8 Filter>** and acknowledge by .

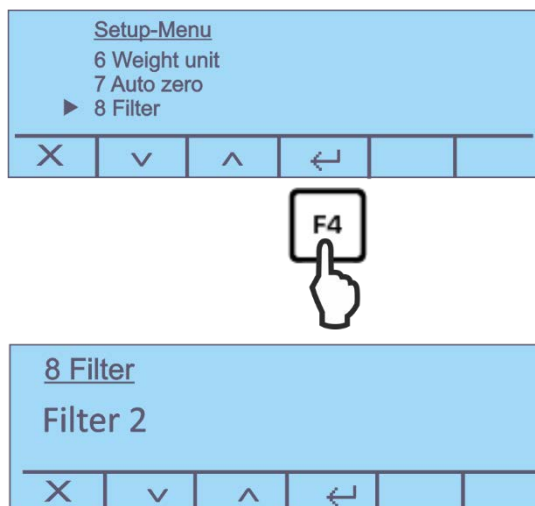

⇒ Press  to select the desired setting.

Options:



Filter 1 Setting for dosage

Filter 2 The balance reacts quickly and in a sensitive manner, very quiet set-up location

Filter 3 The balance reacts slowly and in a robust manner, busy set-up location

⇒ Acknowledge selection by .

9.2.8 Setting the stability

⇒ Press  to select the menu item **<9 Stability >** and acknowledge by .

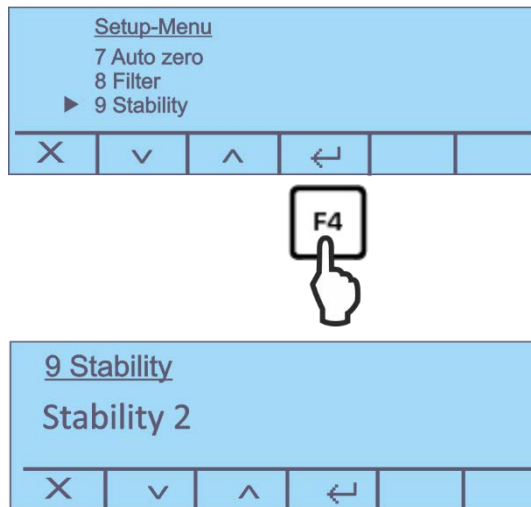

⇒ Press  to select the desired setting.

Options:

Stability 1 Standstill control fast / very quiet set-up location

Stability 2 Standstill control fast + exact / quiet set-up location

Stability 3 Standstill control exact / very busy set-up location

⇒ Acknowledge selection by .

10 Application menu <Moisture analysis>

In this menu all settings and parameters, which influence the moisture analysis and the heating module, are adjusted.

Invoke main menu:

⇒ In the start display press the F1-key, the main menu will appear.

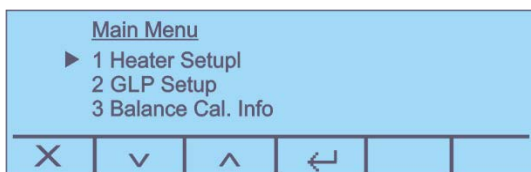
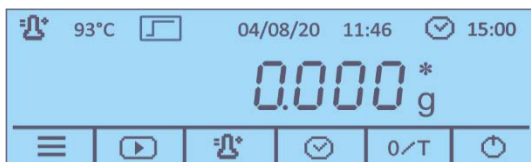



The following submenus are available:

1. For settings of heating module, see chap. 10.1
2. For GLP settings, see chap. 10.2
3. Balance adjustment log, see chap. 8.3
4. Heating module adjustment log, see chap. 8.3
5. Balance adjustment, see chap. 8.1
6. Temperature test, see chap. 8.2.1
7. Heating module adjustment, see chap. 8.2.2

⇒ Select submenu with  and acknowledge by .

10.1 Settings of the heating module

⇒ In the main menu press  to select the menu item **<1 Heater Setup>** and confirm by .

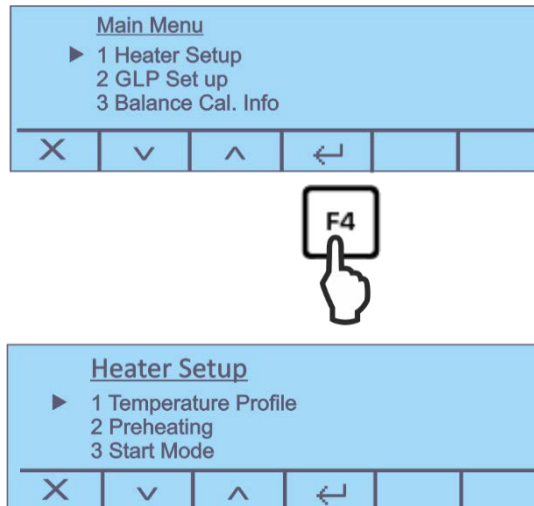

The following functions are available:

1. Heating profile, see chap. 10.1.1
2. Preheating, see chap. 10.1.2
3. Start mode, see chap. 10.1.3
4. Start delay, see chap. 10.1.4
5. Stability test, see chap. 8.1

⇒ Select desired function with  and acknowledge by .

10.1.1 Setting the heating profile

Two options are available to adapt the drying characteristics optimally to the sample being used:

Standard drying

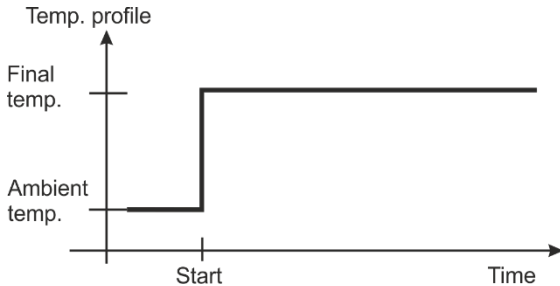

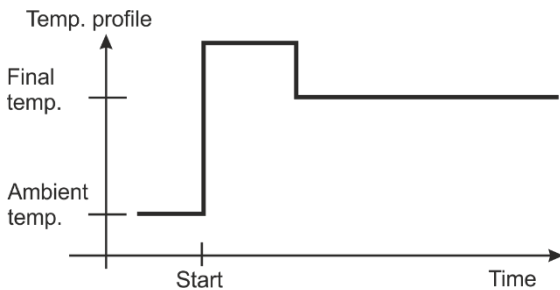

This heating profile is suitable for most samples. The sample is heated to the set temperature at normal output and is then kept at this temperature.

Quick drying



Quick drying is first and foremost suitable for samples with a moisture content of more than 30%. After start-up the temperature will be rising fast and exceed the set drying temperature by approx. 30% for about two minutes. This compensates the evaporation coldness and that way the drying process will be accelerated.

Then the temperature is controlled down to the set value.

⇒ Press  to select the menu item **<1 Temperature Profile>** and acknowledge by .

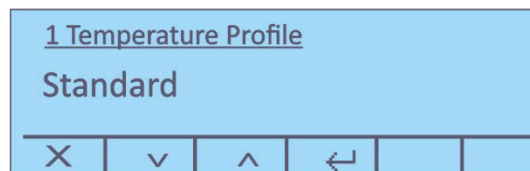
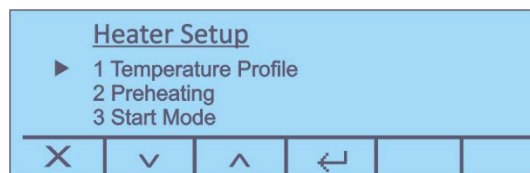

⇒ Select desired setting with  and acknowledge by .

10.1.2 Connect the preheating stage

If necessary, the function „Preheating“ can be activated for preheating the sample chamber before starting the measurement.

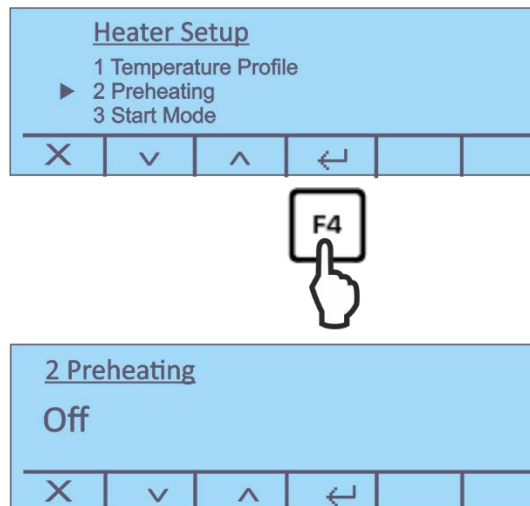

A preheated device may influence the reproducibility of the results as the device is in the same temperature status at every measurement.

- ⇒ Press  to select the menu item **<2 Preheating>** and acknowledge by .



- ⇒ Mit Press  to switch on or off the preheating stage and confirm by .

Procedure with activated function:

- ⇒ In the start display press the button under  and follow the user-guide instructions. Close the lid
Wait until the set temperature is reached.
- ⇒ When the **<Ready>** display appears, press the button under .
- ⇒ Put the empty sample tray in the sample chamber. Close the lid, the scale will automatically be reset to zero.
- ⇒ Weigh-in the prepared sample and close the lid. Measurement will be started automatically.
For further steps, see chap. 11.2.



i For standard applications, a preheating normally is not required.

10.1.3 Start mode

Two options there are available:

Automatic Measurement starts automatically after closing the lid.

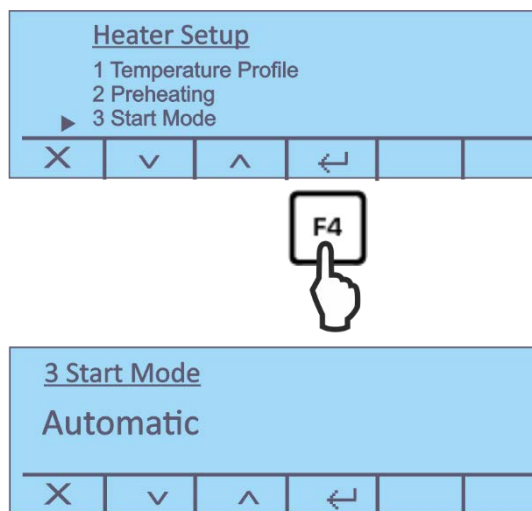

Manual Measurement starts after having pressed .

⇒ Press  to select the menu item **<3 Start Mode>** and acknowledge by .



⇒ Select desired setting with  and acknowledge by .

10.1.4 Start delay

⇒ Press  to select the menu item **<4 Start Delay>** and acknowledge by .

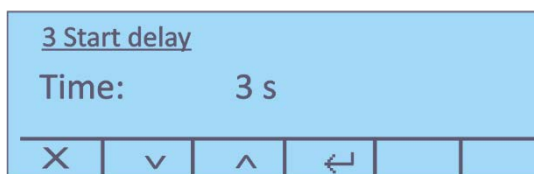
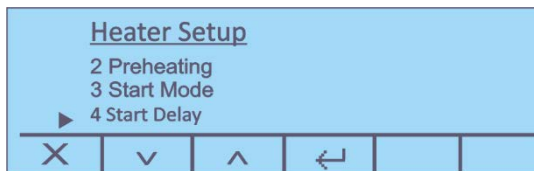



⇒ Select desired setting with  and acknowledge by .
Setting range: 0 – 15 s

10.1.5 Stability test

Two options there are available:

On Measurement starts only after a successful stability test

Off Measurement starts without stability test

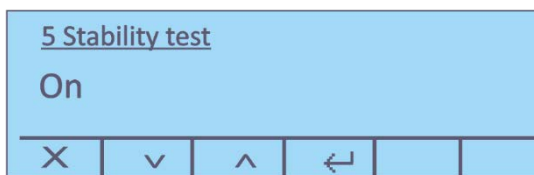
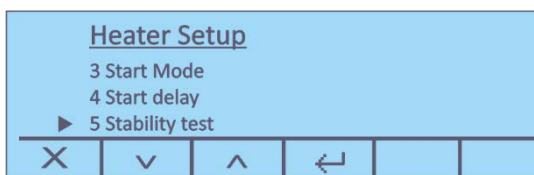

⇒ Press  to select the menu item **<4 Stability test>** and acknowledge by .



⇒ Press  to switch on or off the stability test and confirm by .

10.2 GLP settings

This menu item is used to define which information is to be printed in the header of the weighing logs.



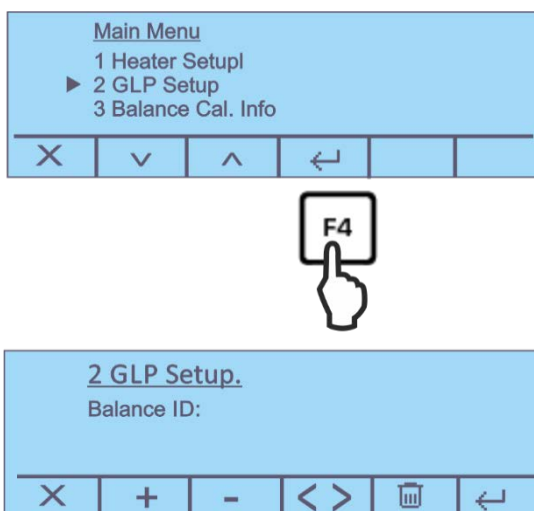



- ⇒ In the main menu press  to select the menu item **<2 GLP Setup>** and confirm by .



The following parameters are available:

1. ID Balance
2. ID User
3. ID Project

- ⇒ Acknowledge by  and enter the text subsequently as follows. The active digit is underlined.

	Select cipher
	Increase cipher (0 – 9) or character (A – Z), (/ . -). Press the key long time to switch over between capital letters and lower case letters.
	Reduce cipher (0 – 9) or character (, [blank], -, A – Z). Press the key long time to switch over between capital letters and lower case letters.
	Press the button once to delete the underlined character. Press the key long time to delete the whole text.
	Confirm input
	Cancel input

11 Moisture analysis

11.1 Define the drying method

The optimum drying parameters (drying temperature and drying period) depend on the type and size of the sample and the required accuracy of the measuring result. In most cases it is only possible to find out the sample-specific parameters by trial and error.

or

Guidance is available in form of existing standards, in-house directives or recommendations.

For examples please also refer to our application manual which you can download from our KERN- Homepage (www.kern-sohn.com).

The following parameters can be set for defining a method:

- Drying temperature, see chap. 11.1.1.
- Switch-off criterion, see chap. 11.1.2
- Heating profile, see chap. 10.1.1
- Result display, see chap. 11.4

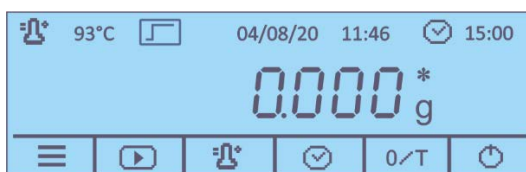

11.1.1 Setting the drying temperature

The drying temperature influences considerably the measuring time. It must be selected in a way that the sample neither does decay nor changes its chemical structure. A too deep drying temperature lengthens unnecessarily the drying time.



⇒ In the start display press , the current setting will be displayed





⇒ Select the desired temperature with   and confirm by , setting range 35 °C – 160°C.

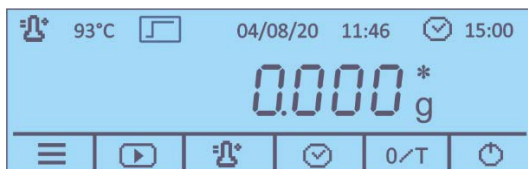

11.1.2 Adjust the switch-off criterion

A switch-off criterion defines under which conditions the device is supposed to cancel the drying process. Cut-off criteria save continuous time checks and manual cancelling of drying. Furthermore they ensure that measurements are always carried out under the same conditions and provide for reproducible measurements. Two different switch-off criteria can be selected; either automatic or time-controlled

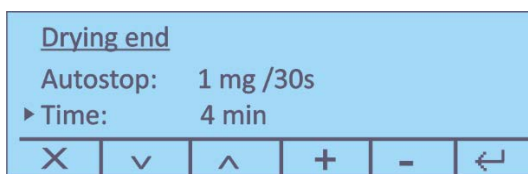

⇒ In the start display press , the current setting will be displayed; The cursor  displays the current setting



⇒ Press  to select the switch-off criterion and adjust by .

Autostop The integrated scale continuously determines the weight loss of the sample during drying. If the loss of weight per time unit (30 s) drops below the set nominal value, drying will be cancelled automatically and the measurement result displayed.
Setting range:

- Auto (3mg/30s; factory setting)
- 1 mg/30 s – 10 mg/30 s, selectable

Time When this switch-off criterion is selected, the measurement will continue until the set drying time has elapsed.
Setting range: 1 min – 99 min.

⇒ Acknowledge selection by .

11.2 Carrying Out Measurement

Having defined the drying parameter (see chap. 11.1) for your sample, measurement can be started. The display shows the current settings and guides you step by step through the measurement process.

Display before starting the measurement:



Pos.	Designation
[1]	Set drying temperature
[2]	Active heating profile
[3]	Current date
[4]	Current time
[5]	Active switch off criterion

Start measurement:



⇒ Press the button under  and follow the instructions of the operator guidance



When the preheating stage is connected, wait until the set temperature is reached (for the procedure, see chap. 10.1.2).

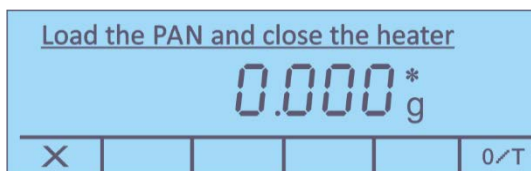

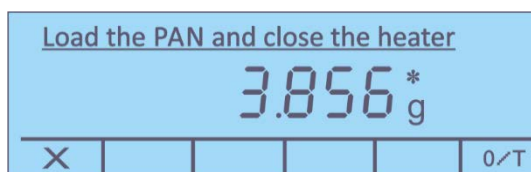

⇒ Place the empty sample tray on the removal aid and put into the sample chamber.

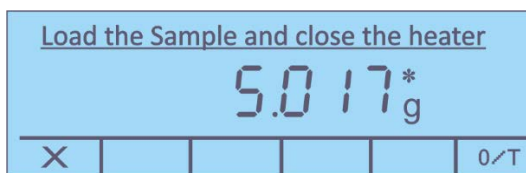

⇒ Close the lid and wait until the scale will automatically be reset to zero.

- ⇒ Weigh-in the prepared sample and close the lid. Measurement will be started automatically.



- i**
- If measuring does not start automatically, the equipment is preset for manual start. Press  for start.
 - Manual or automatic start can be selected in the menu, see chap. 10.1.3
 - Observe hazard information, see chapter 5.3 “Hazards during and after measuring”

- ⇒ When connecting an optional printer and activating the GLP-function, the edition of a measurement log will start, depending on the setting in the menu, see chap. 12.2.1.

- ⇒ The measurement process can be monitored in the display.

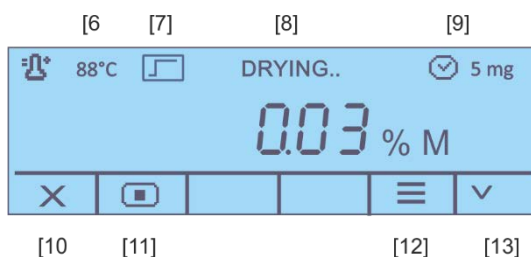

Pos.	Designation
[6]	Current temperature
[7]	Active heating profile
[8]	Status <Drying process is running>
[9]	Active switch off criterion
[10]	Interrupt the drying process
[11]	Stopping the drying process
[12]	Display the current drying parameters
[13]	Switch over the unit of the results display, see chap. 11.4 (% moisture ➔ %dry content ➔ %Atro ➔ resid.weight [g])



When drying is finished, you will hear an acoustic signal and the heating will be shut off.

The result is displayed.



Pos.	Designation
[14]	Exit the drying program / back to start display
[15]	Print out the measurement log
[16]	(de)activate, edit GLP parameters
[17]	Display of start- and residual weight including date and time
[18]	Switch over the unit of the results display, see chap. 11.4 (% moisture → %dry content → %Atro → resid.weight [g])

Finish the measurement:

- ⇒ Open lid and remove the sample with the help of the removal aid.
Caution: Caution! Sample tray and all parts of the sample chamber are hot!
- ⇒ For further measurements press  and confirm the inquiry **<Are you sure>** by . The result is deleted from the display, the start display appears.

11.3 Sample logs (KERN YKB-01N)

- **Unit „Display of results“**
When an optional printer is connected, an adjustment log can be edited by pressing .

GLP <on->	GLP <off->
<pre> ----- 13/08/20 10:14:28 ----- ID Waage: WIC201234 ----- ID User: MUSTERMANN ----- ID Projekt: KERN ----- Standard 160° C Autostop 0 5 mg/30s ----- 13/08/20 10:05:15 G. Start 6.316 g ----- 13/08/20 10:11:18 G. Ende 5.004 g ----- Feuchte 20.77 % M ----- Unterschrift: ----- </pre>	<pre> ----- 13/08/20 10:21:48 ----- Standard 160° C Autostop 0 5 mg/30s ----- 13/08/20 10:05:15 G. Start 6.316 g ----- 13/08/20 10:11:18 G. Ende 5.004 g ----- Feuchte 20.77 % M </pre>

➤ **Sample log during measurement**

When connecting an optional printer and activating the GLP-function, the edition of a measurement log will start, depending on the setting in the setup menu.

```
Menu setting: SetupRS232 Printout time 30 s, see chap. 12.2.1

-----
13/08/20 10:05:15
-----
ID Waage:
WIC201234
-----
ID User:
MUSTERMANN
-----
ID Projekt:
KERN
-----
Standard          160° C
Autostop          0.5 mg/30s
-----
13/08/20 10:05:15
G. Start          6.316 g
-----
10:05:45          0.46 % M
10:06:15          1.93 % M
10:06:45          3.94 % M
10:07:15          6.24 % M
10:07:45          8.68 % M
10:08:15          11.22 % M
10:08:46          13.79 % M
10:09:16          16.38 % M
10:09:46          18.65 % M
10:10:16          20.32 % M
10:10:46          20.72 % M
10:11:16          20.77 % M
-----
13/08/20 10:11:18
G. Ende          5.004 g
-----
Feuchte          20.77 % M

Unterschrift:
-----
```

i The display values are transferred to the PC in the previously defined output interval in connection with our transfer software Balance connection (KERN SCD 4.0).

In the same time a drying curve can be represented graphically. It shows the progress of the drying procedure in real time and can help you to check and evaluate the results.

11.4 Results display

During and after the measurement, the display can be switched over to the different units by 

% Moisture

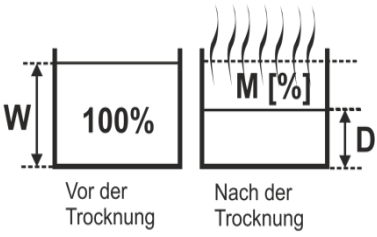

The moisture content of the sample will be displayed in percentages of the wet weight (= initial weight).

% Dry material content

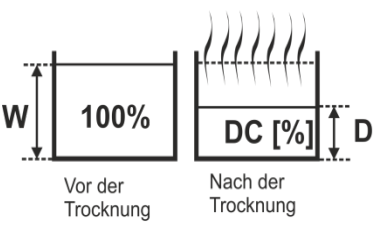

The dry material content (DC) of the sample will be displayed in percentages of the wet weight (=initial weight)

Residual weight in grams

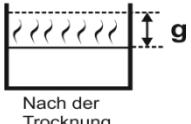

Display shows the weight of the sample in grams.

ATRO



ATRO is a unit which is exclusively used in the timber industry.

12 RS 232 interface

Condition:

The following conditions must be met to provide successful communication between the moisture analyzer and the printer.

- Use a suitable cable to connect the moisture analyzer to the interface of the printer. Faultless operation requires an adequate KERN interface cable.
- Communication parameters (baud rate, bits and parity) of moisture analyzer and printer must match.

12.1 Technical data

Connection 9 pin d-subminiature bushing

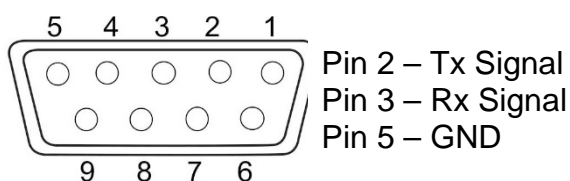



Baud rate 1200 / 2400 / 4800 /9600 wählbar

Parity 8 data bits, 1 stop bit, no parity bit

12.2 Adjusting the interface parameters

Call up menu <RS 232>:

- ⇒ In the start display keep pressed the F1-key for 2 seconds, then release. The setup menu is displayed, see chap. 9.1
- ⇒ Press  to select the menu item <1 Serial output> and acknowledge by .

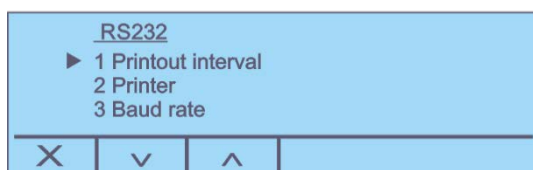
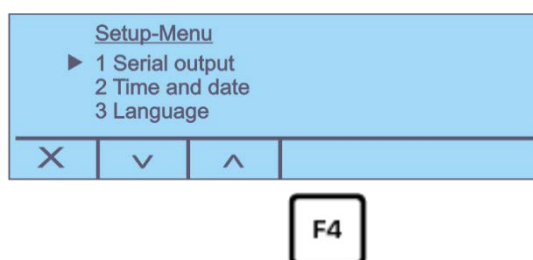



The following parameters are available:

1. Printout time, see chap. 12.2.1
2. Printer, see chap. 12.2.2
3. Baud rate, see chap. 12.2.3
4. GLP on/off, see chap. 12.2.4

⇒ Use  to select the parameters of the following chapters.

12.2.1 Setting the output interval

⇒ In the RS 232-menu press  to select the menu item **<1 Printout Interval >** and confirm by .

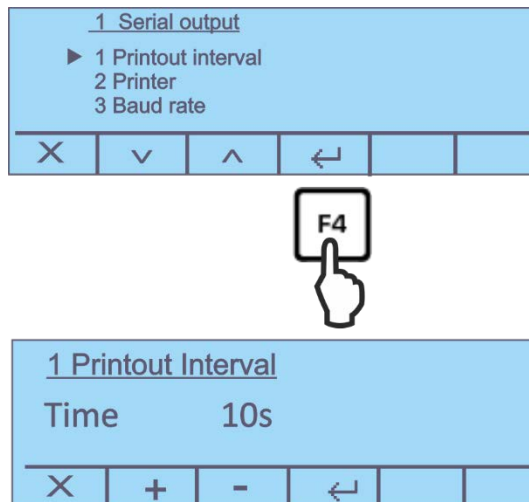

⇒ Press  to select the desired setting.



Options:

- | | |
|--------------------|-----------------------------------------------|
| off | Output interval switched off |
| End of measurement | Automatic log output after end of measurement |
| Time | Output interval selectable 5 – 250 sec |

⇒ Acknowledge selection by .

12.2.2 Select printer type

Press  to define the printer type for your printout.

⇒ Press  to select the menu item **<2 Printer>** and acknowledge by .

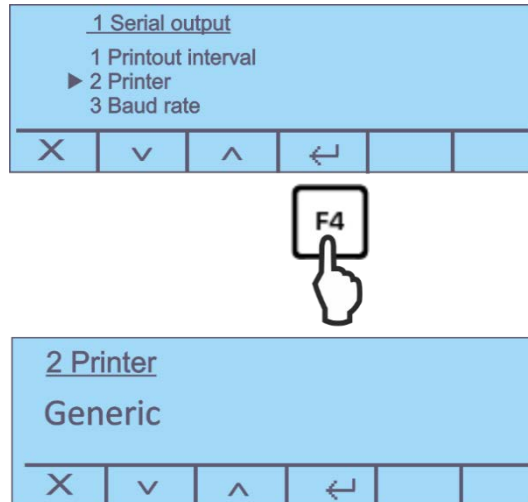



⇒ Select desired setting with  and acknowledge by .

Options:

- Standard printer
- T/LP-50 (printer with LP-50 protocol)

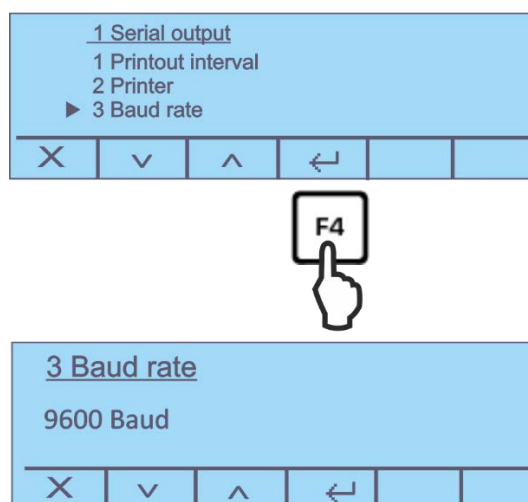

12.2.3 Setting the baud rate

⇒ In the RS 232-menu press  to select the menu item **<3 Baud rate>** and confirm by .



⇒ Select desired setting with  and acknowledge by .

12.2.4 Turn on/off GLP function

⇒ In the RS 232-menu press  to select the menu item **<4 GLP On/Off >** and confirm by .

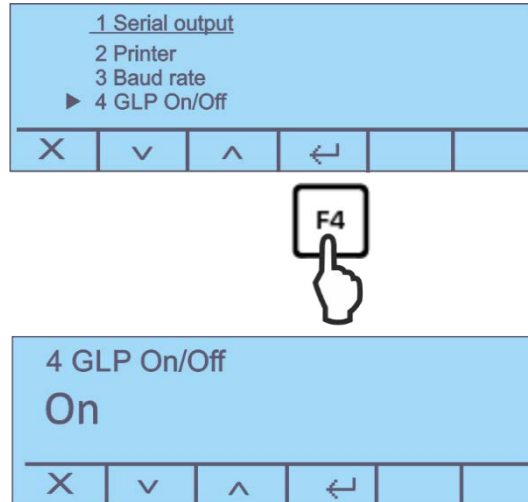

⇒ Press  to switch on or off the GLP-conform output and confirm by .

13 General information concerning moisture analysis

13.1 Application

In all cases where moisture is added to or removed from products, a fast determination of the moisture content is of enormous importance. For countless products the moisture content is not only a quality feature but also an important cost factor. Very often fixed limits for moisture content apply to the trade in industrial or agricultural goods as well as chemical or food products which are defined by terms of delivery and general standards.

13.2 Basics

The Halogen Moisture Analyzer is used to determine the moisture content of almost any substance. The instrument works according to the thermogravimetric principle. A halogen lamp dries the sample substance that is being examined, while the precision balance integrated in the instrument continuously measures the weight of the sample. In the process, the total weight loss will be interpreted as moisture content.

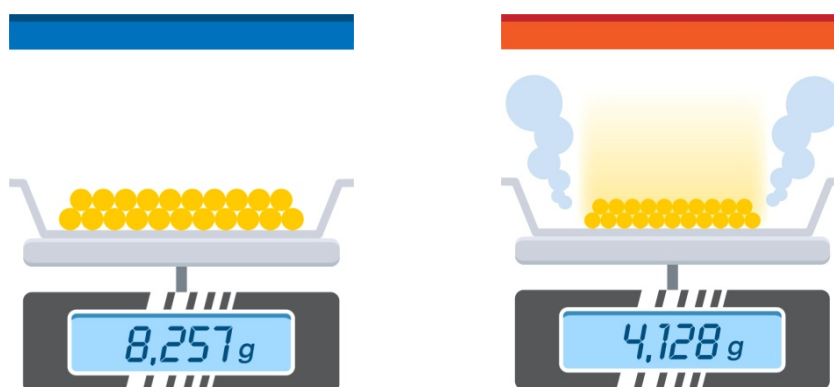

The main benefit of using a halogen lamp is the shortening of the measuring time compared to conventional drying methods. In addition, the sample is heated very evenly by the radiant heater, as it is positioned in a ring above the sample material. This results in very good repeatability of the measurement result. The basis for calculating the moisture content is the amount of weight the sample has lost when drying is complete. Final results, intermediate results, procedures and method parameters can be documented by connecting an optional printer.

13.3 Drying process

The conventional drying chamber method follows the same principle, with the exception that this method requires a considerably longer measuring period. . In accord with the drying chamber method, the sample is heated from the outside to the inside by a hot air current, so as to remove the moisture. The radiation applied in the KERN DAB penetrates mainly the sample in order to be transformed inside it into heat energy that is, warming from the inside to the outside. A minor amount of radiation is reflected by the sample, a reflection that is less in dark samples than in light-coloured ones. The depth of penetration of the radiation depends on the permeability of the sample. For samples with low transmittance, the radiation only penetrates the upper layers of the sample, which can lead to incomplete drying, the formation of a crust or burnt areas. For that reason the preparation of a sample is of great importance.

13.4 Comparison with a reference procedure

Often legal regulations or sector or company-specific instructions must be observed when measuring the moisture content of substances. The oven method (weight loss by drying) or Karl Fischer titration are usually used as a reference method.

However, the use of a moisture analyzer is acceptable if you can demonstrate that the results obtained using this method are equivalent to those obtained by the oven-drying method and are equally accurate. To do this, you must create a drying method for the moisture analyzer and compare this with the oven-drying method over several sets of analyses.

You should also note that the samples are heated by convection in the drying oven. This means that the samples need to be at the same temperature as the drying oven. When a moisture analyzer is used, the sample is heated and dried by absorbing infrared radiation from the heating element. The temperature and drying time of the sample depend on its absorption properties.

13.5 Handling samples

Sample material

Easy to determine are usually samples with the following characteristics:

- Grainy to powdery, pourable solids
- Thermally stable materials, emitting the moisture to be determined easily without other substances evaporating at the same time
- Liquids that vaporize to leave a dry substance without developing a film

Difficult to determine may be samples that are:

- Viscous or sticky
- Become incrustated easily or tend to form a film
- Decompose easily under the influence of heat or emit various elements

Sample-taking

Sample-taking has a great impact on the reproducibility of measurement results:

- In order to ensure that the sample is representative of the total quantity, take as many samples as possible from different places and mix them well
- Take an adequate sample quantity
- Avoid picking up or releasing moisture when taking a sample, that is, work as quickly as possible.
- If you have to take several samples at the same time, store them in air-tight containers without air pockets (fill to the top) so as to prevent changes to them during storage.

Preparing a sample



Correct sample preparation after sample-taking is also important for reproducible and reliable results.

- Ensure even particle size.
- To achieve high reproducibility, use the same sample quantity throughout, such as 5 g.
- If required, crush the sample as this makes for better and quicker moisture release during the drying process.
- Make sure that the sample does not heat up during crushing as this may result in early loss of moisture during the preparation.
- You can achieve crushing by using a powerful electric crusher (e. g. 1000 Watt) or a pestle or simply by cutting.

Sample size

Select your sample as small as possible and merely as large as necessary.

- A sample that is too large will take longer to dry and will therefore require a longer measuring procedure.
- A sample that is too small on the other hand may result in a non-representative measurement result.
- The more inhomogeneous the sample, the larger you should make your sample quantity in order to achieve a reproducible result.
- Experience has shown that a practical sample quantity is approximately 3 to 10 g (2 to 5 mm high). Otherwise, incomplete drying, longer measuring time, incrustation, burns and non-reproducible measuring results may occur.

Sample distribution

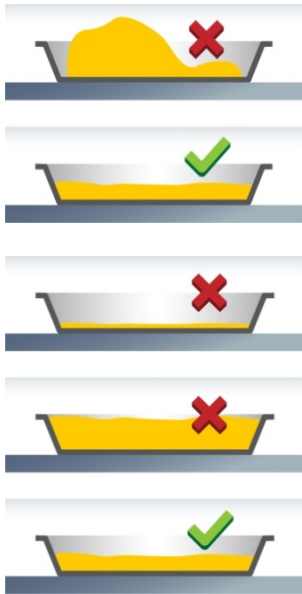

- Distribute powdery and grainy samples evenly across the sample tray (avoid piling up).
- Always apply the same sample quantity in order to ensure high reproducibility.
- Apply the correct sample quantity. The tray should be covered thinly and evenly across the entire area.
- Cover the sample with a fibre glass filter if you are dealing with liquid, fatty, melting or highly reflective samples.

Special samples

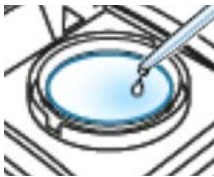

The fibre glass filter is quite often a suitable instrument when dealing with special samples.

- **Liquid, paste-like, melting samples**

Tare the filter together with the sample tray before applying the sample.

Liquid samples (such as emulsions) tend to form droplets on the sample tray due to the surface tension present in the liquid. This hinders a quick drying process because evaporation is restricted to a limited liquid surface. The capillaries of the filter distribute the liquid contained in the sample evenly across the entire area. This increases the sample surface allowing the moisture to evaporate more easily, faster and completely. This reduces drying times by up to 50 %.

- **Temperature-sensitive samples**

Tare your filter together with the sample tray before covering the sample from above with the filter. The cover creates a <<new surface>> for the sample. It protects the surface of the temperature-sensitive sample against direct radiation. Burns are prevented and gentler heating of the sample is achieved by means of convection rather than radiation.

Temperatures can be set higher and the moisture evaporates quicker.

This helps you to achieve good reproducibility for fatty samples.

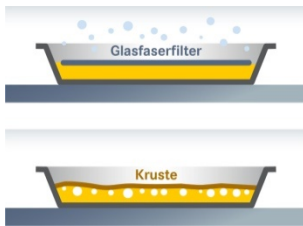

- **Crust or skin forming samples**

Tare your filter together with the sample tray before covering the sample from above with the filter.

Sugar-containing samples (such as glucose syrup) may develop a crust during drying, resulting in a sealed surface.

The use of a fibre glass filter quite often prevents or at least reduces the forming of skin or crusts.



- **Dyed samples**

Tare your filter together with the sample tray before covering the sample from above with the filter.

Irregularly dyed samples heat up varyingly strong due to differing absorption characteristics. The fibre glass filter ensures even heating.

Colourless / transparent samples do not reflect.

Sample trays



Always use KERN one-way sample trays. The measurement results very often turn out irreproducible if sample trays are reused.

- Sample residue may remain on the sample tray after cleaning.
- Residues from cleaning agents may evaporate during the next measurement.
- Do not use deformed sample trays as these will not rest flush with the surface and may result in incorrect measurement results.

14 Servicing, maintenance, disposal



Before any maintenance, cleaning and repair work disconnect the appliance from the operating voltage.

14.1 Cleaning



Only carry out cleaning tasks when the equipment has cooled down.

CAUTION

Open the lid and remove and clean all of the parts in sequence.

Please do not use aggressive cleaning agents (solvents or similar agents), but a cloth dampened with mild soap suds. Ensure that no liquid penetrates into the device. Polish with a dry soft cloth.

Loose residue sample/powder can be removed carefully with a brush or manual vacuum cleaner.

14.2 Servicing, maintenance

- ⇒ The appliance may only be opened by trained service technicians who are authorized by KERN.
- ⇒ Ensure that the balance is regularly calibrated, see chap. Monitoring of test resources.

14.3 Disposal

- ⇒ Disposal of packaging and appliance must be carried out by operator according to valid national or regional law of the location where the appliance is used.

15 Instant help

Possible causes of errors:

In case of an error in the program process, briefly turn off the balance and disconnect from power supply. The weighing process must then be restarted from the beginning.

Fault	Possible cause
Display is not lit up.	<ul style="list-style-type: none">• The appliance is not switched on.• The mains supply connection has been interrupted (mains cable not plugged in/faulty).• Power supply interrupted.• Fuse has blown
The display does not change when a sample is being loaded	<ul style="list-style-type: none">• Sample tray / tray holder is fitted incorrectly.
The weight display changes constantly / the stability display does not appear.	<ul style="list-style-type: none">• Sample tray has contact with wind protection device or heated cover.• Draught/air movement• Table/floor vibrations• Electromagnetic fields / static charging (choose different location/switch off interfering device if possible)
Incorrect measuring result	<ul style="list-style-type: none">• Check adjustment• No resetting to zero before loading the sample
Measurement is taking too long	<ul style="list-style-type: none">• Incorrect shut-down criteria set
Measurement is not reproducible	<ul style="list-style-type: none">• Sample is not homogenous• Drying time is too short• Drying temperature too high (e.g. oxidation sample material, boiling point of sample exceeded)• Temperature sensor soiled or defective
Drying does not start	<ul style="list-style-type: none">• Heated cover open• The mains supply connection has been interrupted (mains cable not plugged in/faulty).