

# **KERN**

**KERN & Sohn GmbH**

Ziegelei 1  
D-72336 Balingen  
E-mail: [info@kern-sohn.com](mailto:info@kern-sohn.com)

Telephone +49-[0]7433-9933-0  
Fax: +49-[0]7433-9933-149  
Internet: [www.kern-sohn.com](http://www.kern-sohn.com)

## **Tripod assembly manual**

### **KERN EOC-A05**

Version 1.1  
12/2016  
GB



**EOC-A05-IA-e-1611**



# KERN EOC-A05

Version 1.1 12/2016

## Tripod assembly manual

### Table of contents







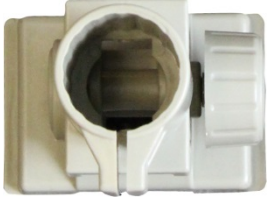

1	Technical data .....	2
2	Scope of delivery .....	3
3	Overview .....	4

English

## 1 Technical data

<b>KERN</b>	<b>EOC-A05</b>
Tripod height	33 cm

## 2 Scope of delivery

 <p>Tripod</p>	 <p>Display holder</p>
 <p>Tripod foot (exemplary figure)</p>	 <p>Screw, 1 piece</p>
 <p>Plastic cylinder</p>	 <p>Screw with nut, 1 piece</p>
 <p>Screw, 4 pieces</p>	 <p>Cable guide with screw, 3 pieces each</p>
 <p>Support screw, 1 piece</p>	 <p>x 3</p>

### 3 Overview

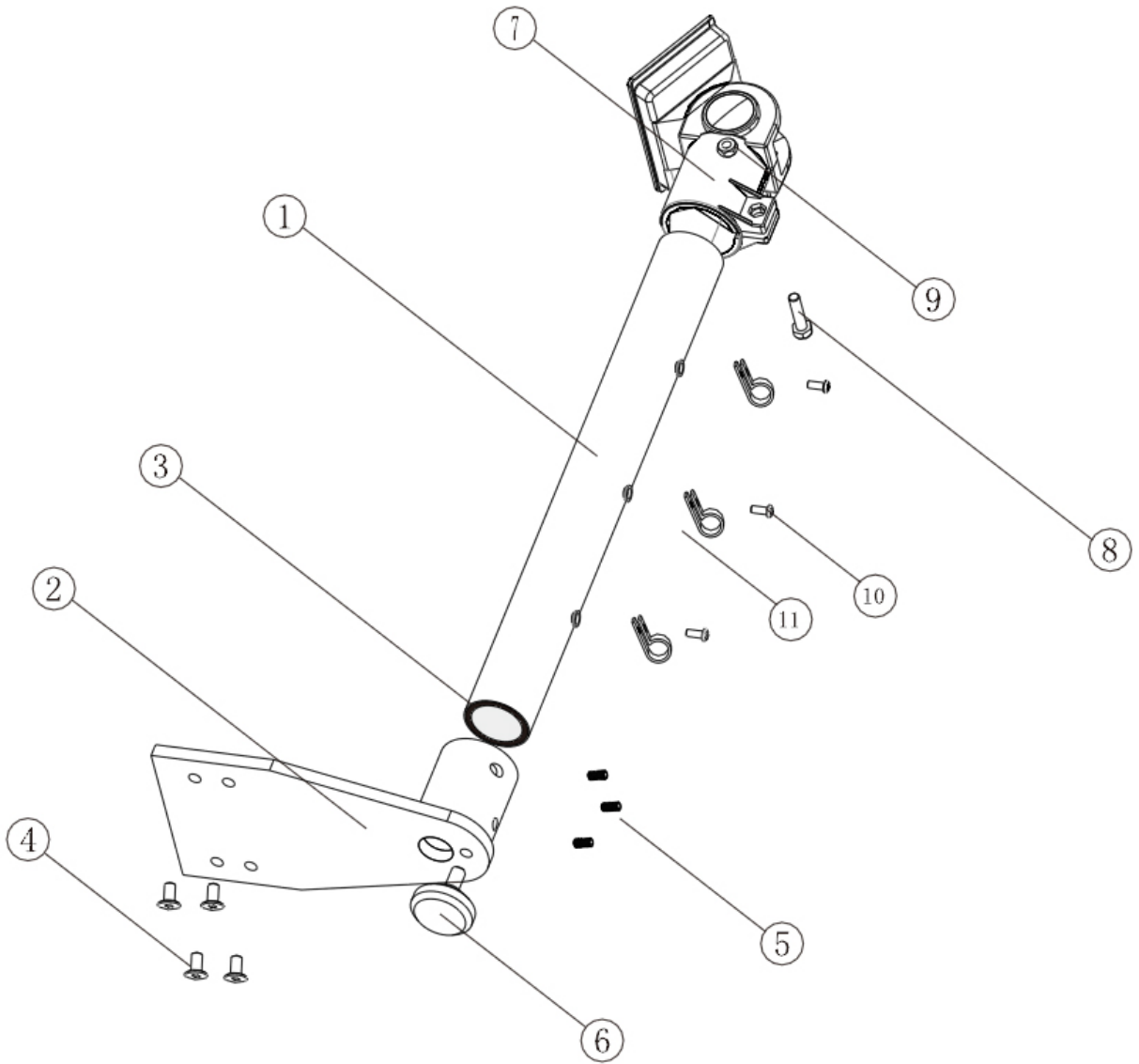

1	Tripod	7	Display holder
2	Tripod foot	8	Screw
3	Plastic ring	9	Screw
4	Screw	10	Screw
5	Screw	11	Cable guide
6	Support screw		

